



# PRODUCT & PRICE GUIDE

JANUARY 2019



# Now That's SMART FABRICATION™

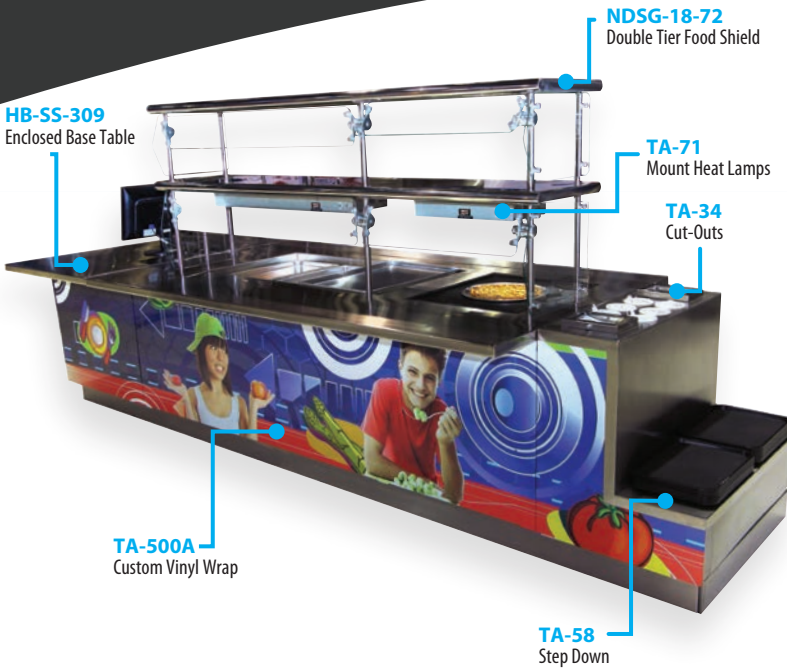

## LOOK AT WHAT WE'RE DOING

### CUSTOM FABRICATION

- Installation of Buyout Equipment
- Buyout Equipment Can Be Pre-Wired
- Load Centers Added
- Food Shields
- Laminate & Custom Vinyl Wraps Designed In-House



Concealed Load Centers for safety & easy access

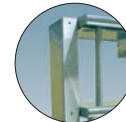

Custom Electrical Chases for buyout equipment



Wall Flashing in 16, 18 or 20 Ga. Stainless Steel & polished to a satin finish

## CREATE, ACCESSORIZE, UPSSELL

Buildatable And Buildasink Are Simple And Easy-To-Use Website Tools That Allow You To Click And Choose Accessories For Either A Work Table Or Sink.

**buildatable™**  
by ADVANCE TABCO®

**buildasink™**  
by ADVANCE TABCO®

For Smart Fabrication™ Quotes

Email [Smartfab@advancetabco.com](mailto:Smartfab@advancetabco.com) or call our Estimating Department at 800-498-6634.

## ONLINE SERVICES AVAILABLE AT [www.advancetabco.com](http://www.advancetabco.com)

### ACCOUNT ACCESS - CREATE A CUSTOMER LOG-IN & FOLLOW THE COMPLETE PROCESS OF YOUR ORDERS

#### KEEP TRACK OF:

- Print Status
- Shipment Tracking Status
- Real-time Order Status
- Latest Sales Flyer
- Excess Inventory Lists

#### ALSO AVAILABLE ONLINE:

- Spec Sheets, CAD & Revit Drawings
- Installation Guides
- Product Support
- Photo & Video Library
- Literature Requests

YOU CAN ALSO FIND US ON AUTOQUOTES & KCL CADALOG

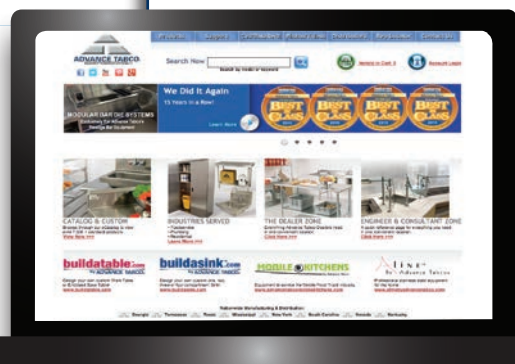

CUSTOMER SERVICE IS AVAILABLE TO ASSIST YOU! (8:30AM – 8:00PM EST)

# TABLE OF CONTENTS

## SINKS & SINK ACCESSORIES

Drop-In Sinks.....	3-5
Undermount Sinks.....	5
Hand Washing Sinks.....	6-11
Mop Sinks & Mop Sink Cabinets ..	14-15
Multi-Station .....	16
Hand Sink Mods & Accessories ..	8, 11-13, 19
Faucets, Drains & P-Traps	8, 11, 13, 30
Specialty Sinks .....	25
Mobile & Silver Soak .....	28
Budget Skullery Sinks .....	28
Budget Skullery Sink Accessories.....	28
NSF Regaline Sinks.....	20-24
NSF Fabricated Sinks .....	26-27
Sink Mods & Accessories .....	29-30
Floor Troughs, Floor Drains & Water Receptacles .....	31
Sink Cabinets .....	47
Integral Sinks.....	59

## TABLES & TABLE ACCESSORIES

Standard Work Tables.....	32-43
Enclosed Base Tables .....	44-46
Beverage Tables .....	46
Demo Tables .....	49
Tables with Sink .....	49
Corner Tables.....	49
Mobile Hand Sinks .....	47
Mixer Tables .....	50
Wall Mounted Tables.....	50
Equipment Stands.....	51
Filler Tables .....	51
Poly Top Tables.....	54
Work Table Modifications & Accessories .....	55-62
Wood Top Tables.....	52-53
Drawers & Accessories .....	60-61
Casters .....	62
Electrical Utility Chase.....	70

## FOOD SHIELDS

Food Shields with S/S Shelf.....	63-64
Food Shields with Glass Top .....	65
Self Serve Food Shields (No Top).....	66
Stationary Food Shields .....	66
Portable Food Shields.....	67
Food Shield Accessories .....	67
LED Lighting.....	67

## STAINLESS STEEL SHELVING

Table Undershelving .....	62
Table Mounted Shelving .....	68-70, 75
Specialty Shelving .....	67-68, 72
Wall Mounted Shelving.....	69-70
Ceiling Mounted Shelving .....	29, 71-72
Shelving Accessories .....	73
Sorting Shelves For Dishtables .....	84

## POT RACKS

Shelving with Pot Racks .....	72
Table Mounted .....	74
Leg Mounted .....	76
Ceiling Mounted .....	76
Wall Mounted .....	76

## DISHTABLES

Soil Dishtables.....	78-79, 81
Clean Dishtables .....	80-81
3 Compartment Sink w/ Dishtable ....	82
Condensate Hoods.....	82
Vent Riser .....	82
Dishtable Modifications & Accessories .....	83-84

## COUNTERTOPS

Stainless Steel Countertops.....	53
Integral Sinks.....	59

## CABINETS & WALL FLASHING

Stainless Steel Dish Cabinets .....	46
Storage Cabinets .....	48
Sink Cabinets .....	47
Wall Cabinets .....	48
Storage Cabinets .....	48
Chemical Cabinets.....	15, 48
Stainless Steel Wall Flashing .....	72

## Underbar Basics™

### UNDERBAR EQUIPMENT

#### Underbar Drop-Ins

Drop-In Water Stations.....	86
Drop-In Bar Hand Sinks .....	86-87
Drop-In Ice Bins .....	86-87
Drop-In Bar Sinks .....	87
Drop-In Countertop Drain Pans .....	87

#### Bar Drink Rails

Drink Rails .....	87
-------------------	----

#### Free-Standing Bar Sinks

Bar Hand Sinks .....	87
----------------------	----

Bar Hand Sinks with Built-In Soap & Towel Dispensers.....	88
Bar Hand Sink Modifications & Accessories .....	88, 112
Bar Sinks .....	89
Bar Sink/Ice Bin Combos.....	89

#### Glass Rinsers

Glass Rinser .....	87
--------------------	----

#### Ice Bins

Drop-In Ice Bins .....	86-87
Free-Standing Ice Bins.....	90
Ice Bin with Bottle Storage .....	91
Portable Ice Bin .....	91
Ice Bin & Drainboard Combo.....	91
Pass-Thru Ice Bins .....	92
Beer Boxes .....	95
Ice Bin Mods & Accessories ..	90, 92, 112

#### Pass-Thru Work Stations

Standard Pass-Thru Workstations .....	92
---------------------------------------	----

#### Bar Drainboards

Free Standing Bar Drainboards .....	93
Recessed Bar Drainboards.....	93
Beer Drainers .....	93
Frozen Drink Machine Stands.....	93
Drainboard with Blender Station.....	94
Drainboard Cabinets.....	96

#### Blender Stations

Blender Station with Dump Sinks.....	94
Double Step Blender Stations.....	94
Blender Station Mods & Accessories .....	94, 112, 114

#### Uni-Serv Speed Bars

Complete Speed Bar Unit.....	94
------------------------------	----

#### Bar Storage Units

Liquor Bottle Displays .....	95
Glass Rack Storage Cabinets.....	96
Drainboard Cabinets.....	96
With Dump Sink & Waste Chute .....	96
Storage Unit Accessories & Modifications .....	95-96, 112, 114

#### Speed Rails

Stainless Steel Speed Rails .....	97
Black Plastic Speed Rails .....	97
Heavy Duty Speed Rails .....	97

#### Underbar Mods & Accessories

Underbar Mods & Accessories ..	112-113
Underbar Faucets .....	114

Continued on Page 2

# TABLE OF CONTENTS



## UNDERBAR EQUIPMENT

### Prestige Modular Bar Die Systems

Exclusive Bar Die System ..... 99-100

### Prestige Free-Standing Bar Sinks

Bar Hand Sinks ..... 101

Bar Hand Sinks with Built-In

Soap & Towel Dispensers..... 101

Bar Hand Sinks with Cabinet Base ... 101

Bar Sink Mods

& Accessories ..... 101, 113-114

Bar Sinks ..... 102

### Prestige Ice Bins

Free-Standing Ice Bins..... 103

Ice Bin & Bottle Storage..... 103

Pass-Thru Ice Bins ..... 104

Beer Box..... 104

### Prestige Pass-Thru Work Stations

Standard Pass-Thru Workstations .... 104

Overshelves For Pass-Thru

Workstations..... 104

### Prestige Bar Drainboards

Free Standing Bar Drainboards ..... 105

Recessed Bar Drainboards..... 105

Beer Drainers ..... 105

Frozen Drink Machine Stands..... 105

Drainboard Fillers..... 106

With Blender Station..... 107

Drainboard Storage Cabinets ..... 108

Drainboard Glass Rack Storage ..... 108

### Prestige Blender Stations

With Deep Drawn Sink ..... 107

With Drainboard ..... 105

Blender Shelf ..... 110

### Prestige Uni-Serv Speed Bars

Complete Speed Bar Unit ..... 105

### Prestige Bar Storage Units

Point of Service Cabinet..... 105

Drainboard Storage Cabinets ..... 108

Glass Rack Storage Cabinets..... 109

Liquor Bottle Displays ..... 109

### Trash Receptacles

Trash Receptacle Cabinets..... 108

### Prestige Speed Rails

Stainless Steel Speed Rails ..... 110

Hang-On Style Speed Rails ..... 110

### Under Bar Mods & Accessories

Soda Gun Holder for Prestige®

Pass-Thru Workstations ..... 113

Prestige Mods & Accessories... 112-113

### BACK BAR REFRIGERATION & COOLERS

Glass Froster..... 111

Bottle/Can Coolers..... 111

Back Bar Refrigeration ..... 111

### PORTABLE BARS

ABS Molded Work Top..... 115

Stainless Steel Work Top ..... 115

Stainless Steel Top, Back & Sides ... 115

Portable Bar Mods & Accessories ..... 115

### Heavy Duty Bars

Heavy Duty Bars ..... 116

With Stainless Steel Doors ..... 116

Portable Cash Register Stand..... 116

### HOT/COLD FOOD UNITS

#### Hot Well Drop-In Units

Standard Drop-In Units ..... 118

Slimline Drop-In Units..... 118

Hot Well Drop-In Accessories ..... 118

#### Hot Well Food Tables

Electric Powered Hot Food Tables ... 119

Electric Powered Sealed Well Tables 120

Gas Powered Hot Food Tables ..... 121

Gas Powered Wetbath Tables ..... 122

#### Solid Top Food Tables

Solid Top Food Tables..... 123

#### Cold Well Drop-In Units

Ice-Cooled Drop-In Cold Pan Units .. 124

Refrigerated Drop-In Cold Pan Units .124

#### Cold Food Tables

Standard Ice-Cooled Tables ..... 125

Mechanically Assisted

Cold Pans Tables ..... 126

### Heavy Duty Food Tables

Electric Sealed Hot Well Tables ..... 127

Refrigerated Cold Well Tables ..... 127

Ice-Cooled Tables..... 127

### Everyday Buffet Tables

Electric Hot Well Buffets..... 128

Electric Sealed Hot Well Buffets..... 128

Ice Cooled Buffets..... 129

Solid Top Buffets..... 129

Mechanically Assisted

Cold Pan Buffets ..... 130

Cash Register Stands ..... 130

Silverware Stand..... 130

Everyday Buffet Accessories ..... 133

### Food Table Shelving & Parts

Hot/Cold Food Table Shelving..... 131

Food Shields for Hot/cold Tables ..... 132

Hot Food Table Parts

& Accessories ..... 119-122, 131-134

LED Lighting for Hot/Cold Tables ..... 133

### ALUMINUM RACKS & PANS

Aluminum Racks ..... 135-139

Aluminum Bun Pans..... 140

Aluminum Rack Accessories ..... 140

### Mobile Racks & Carts

Aluminum Pan Trucks ..... 141

Aluminum Dunnage Racks ..... 141

Wire Utility Carts ..... 143

### WIRE SHELVING

Wire Utility Carts ..... 143

Chrome & Green Epoxy

Wire Shelving..... 142-143

Wall Mounted Shelving System..... 144

Wire Shelving Replacement Parts

& Accessories ..... 144

### WARRANTY

Warrantee, Terms & Conditions ..... 145



**= PRODUCTS THROUGHOUT THE PRICE GUIDE WITH THIS ICON ARE SHIPPED VIA UPS**





# DROP-INS

## Drop-In Sinks

Holes Punched 4" O.C. For Faucet Hole Revision Order **K-472 \$115**. Cut-Out Size Requires 1-1/4" Radius Corners. Maximum Counter Thickness Is 2".

**INCLUDES K-52 LEAD FREE COMPLIANT FAUCET & BASKET DRAIN. (DI-1-25 INCLUDES 2" DRAIN WITH STRAINER PLATE)**

(To delete faucet, order K-520MIT and deduct \$22)

All Sinks on this Page Ship Via UPS

### ONE COMPARTMENT

Countertop Mounted, Self Rim Design

For Residential Finish & Packaging,  
Add **K-350 \$325**



#### DI-1-5 \$486

10" x 14" x 5" Bowl  
Overall: 13" x 19"  
Cut-out: 12 1/4" x 18 1/4"  
12 lbs. 2 cu. ft. 20 gauge



#### DI-1-10 \$608

10" x 14" x 10" Bowl  
Overall: 13" x 19"  
Cut-out: 12 1/4" x 18 1/4"  
14 lbs. 2 cu. ft. 20 gauge



#### DI-1-25 \$602

**Space Saver**  
9" x 9" x 5" Bowl  
Overall: 12" x 14"  
Cut-out: 11 1/4" x 13 1/4"  
8 lbs. 2 cu. ft. 20 gauge



#### DI-1-1515 \$728

12 1/4" x 10 1/4" x 6" Bowl  
Overall: 15" x 15"  
Cut-out: 14 1/4" x 14 1/4"  
Requires 1 1/2" Radius Corners  
11 lbs. 2 cu. ft. 20 gauge



#### DI-1-35 \$546

14" x 10" x 5" Bowl  
Overall: 17" x 15"  
Cut-out: 16 1/4" x 14 1/4"  
10 lbs. 2 cu. ft. 20 gauge



#### DI-1-168 \$780

16" x 14" x 8" Bowl  
Overall: 19" x 19"  
Cut-out: 18 1/4" x 18 1/4"  
20 lbs. 3 cu. ft. 18 gauge



#### DI-1-208 \$833

20" x 16" x 8" Bowl  
Overall: 23" x 21"  
Cut-out: 22 1/4" x 20 1/4"  
20 lbs. 3 cu. ft. 18 gauge



#### DI-1-2012 \$957

20" x 16" x 12" Bowl  
Overall: 23" x 21"  
Cut-out: 22 1/4" x 20 1/4"  
20 lbs. 6 cu. ft. 18 gauge

Supplied with K-50 Lead Free Compliant Faucet & Basket Drain  
(To delete faucet, Order K-500MIT and deduct \$22)



#### DI-1-5SP \$1402

**6" Tapered Side Splash**

Splash on Rear and Both Sides  
10" x 14" x 5" Bowl  
Overall: 13" x 19"  
Cut-out: 12 1/4" x 18 1/4"  
16 lbs. 2 cu. ft. 20 gauge



#### DI-1-10SP \$1507

**6" Tapered Side Splash**

Splash on Rear and Both Sides  
10" x 14" x 10" Bowl  
Overall: 13" x 19"  
Cut-out: 12 1/4" x 18 1/4"  
18 lbs. 2 cu. ft. 20 gauge



#### DI-1-30 \$912

**2" Tapered Side Splash**

14" x 10" x 5" Bowl  
Overall: 16" x 15"  
Cut-out: 15" x 14 1/4"  
12 lbs. 2 cu. ft. 20 gauge

Splash on  
All 3 Sides

Includes water  
filler faucet,  
grating & drain



#### DI-1-9 \$952

**Filler Station**  
9" x 9" x 3" Bowl  
Overall: 12" x 14"  
Cut-out: 11 1/4" x 13 1/4"  
15 lbs. 2 cu. ft. 20 gauge

Optional 12" Tapered Side Splash Upgrade **K-12SS \$435**

### Removable 8" Splash Wrap for Existing Drop-In Sinks \$736 ea.

Model #	Fits Drop-In Sink:
K-614A	DI-1-25 & DI-1-9
K-614B	DI-1-5 & DI-1-10
K-614C	DI-1-1515
K-614D	DI-1-30 & DI-1-35
K-614E	DI-1-168
K-614F	DI-1-208 & DI-1-2012
K-614G	DI-1-2812



Protect Your  
Surrounding Area!

### The Largest One Compartment Drop-In Sink in the Industry!

#### DI-1-2812 \$1631

28" x 20" x 12" Bowl  
Overall: 31" x 25"  
Cut-out: 30 1/4" x 24 1/4"  
47 lbs. 7 cu. ft. 16 gauge



Supplied with K-53 Lead Free Compliant Faucet & Basket Drain  
(To delete faucet, Order K-530MIT and deduct \$22)

**WARNING:** Equipment that includes a faucet may expose you to chemicals, including lead, that are known to the State of California to cause cancer or birth defects or other reproductive harm. For more info, visit [www.p65warnings.ca.gov](http://www.p65warnings.ca.gov).

# DROP-INS

## Drop-In Sinks



= Ship Via UPS

Holes Punched 4" O.C. For Faucet Hole Revision Order **K-472 \$115**. Cut-Out Size Requires 1-1/4" Radius Corners.  
Maximum Counter Thickness Is 2".

**INCLUDES K-50 LEAD FREE COMPLIANT FAUCET & BASKET DRAIN** (To delete faucet, order K-500MIT and deduct \$22)

### TWO COMPARTMENT

Countertop Mounted, Self Rim Design



#### DI-2-10 \$1187

10" x 14" x 10" Bowl  
Overall: 25 1/2" x 19"  
Cut-out: 24 3/4" x 18 1/4"  
26 lbs. 4 cu. ft. 20 gauge



#### DI-2-2012 \$1890

20" x 16" x 12" Bowl  
Overall: 45 1/2" x 21"  
Cut-out: 44 3/4" x 20 1/4"  
42 lbs. 9 cu. ft. 18 gauge



#### DI-2-1410 \$1806

14" x 16" x 10" Bowl  
Overall: 33 1/2" x 21"  
Cut-out: 32 3/4" x 20 1/4"  
35 lbs. 6 cu. ft. 18 gauge



#### DI-2-208 \$1477

20" x 16" x 8" Bowl  
Overall: 45 1/2" x 21"  
Cut-out: 44 3/4" x 20 1/4"  
40 lbs. 6 cu. ft. 18 gauge

### THREE COMPARTMENT

Countertop Mounted, Self Rim Design

#### DI-3-10 \$1817

10" x 14" x 10" Bowl  
Overall: 38" x 19"  
Cut-out: 37 1/4" x 18 1/4"  
34 lbs. 5 cu. ft. 20 gauge



#### DI-3-1410 \$2433

16" x 14" x 10" Bowl  
Overall: 50" x 21"  
Cut-out: 49 1/4" x 20 1/4"  
38 lbs. 8 cu. ft. 18 gauge



#### DI-3-1612 \$2741

16" x 20" x 12" Bowl  
Overall: 56" x 25"  
Cut-out: 55 1/4" x 24 1/4"  
60 lbs. 12 cu. ft. 18 gauge



Includes a K-53 Faucet. To delete, order K-530MIT & deduct \$22

**DID YOU KNOW?** 2 & 3 Compartment Drop-In Sinks are N.S.F. Approved when only used in Mobile Food Carts and Kiosks.

# FAUCETS & SPOUTS

## Deck Mounted Faucets, Spouts & Mounting Clips

#### Drinking Bubbler

K-47 \$687



#### 8" Swing Spout

K-50 \$233



#### Water Filler Faucet

K-54

8-1/4" High \$446  
K-54A  
12" High \$549



#### Swing Spout Faucet & Spray

K-58 \$289

8" O.C.



#### Mounting Clips

Extended



For Countertops Over 7/8" & up to 2" Thick

Quantity supplied (4-Pack), varies based on drop-in sink ordered.

K-28 \$13

#### Deck Mounted Single Handle Faucet

K-48 \$481



#### 3-1/2" Gooseneck

K-52 \$210



#### Large 8-1/2" Spout Gooseneck

K-55 \$407

4" O.C.



#### EXTRA HEAVY DUTY Gooseneck

K-62 \$418

4" O.C.

Upgrade



Wrist Handles for Deck Mt. Faucets  
K-316-LU \$109

#### Deck Mounted Faucet with Wrist Handles

K-56 \$307

4" O.C.



#### 6" Deck Mounted Extended Faucet with Wrist Handles

K-208 \$424

4" O.C.



#### REPLACEMENT CARTRIDGES\*

For K-50, K-52, K-53, K-55, K-56

K-00B \$98 (Set of 2)

For K-54 & K-54A Filler Faucet

K-02 \$52

\*Can Only Be Used On Faucets Purchased After January 2016. For Older Faucets, Consult Customer Service.



K-00HB Shown

**WARNING:** Equipment that includes a faucet may expose you to chemicals, including lead, that are known to the State of California to cause cancer or birth defects or other reproductive harm. For more info, visit [www.p65warnings.ca.gov](http://www.p65warnings.ca.gov).

# SMART SERIES™

Countertop Mounted, Self Rim Design

# DROP-INS

## Drop-In Sinks

Maximum Counter Thickness is 2". 8" O.C. Faucet Holes: Unit punched with 1-1/2" Diameter for the hot & cold water supply lines. Center hole punched with 1" Diameter. For Faucet Hole Revision Order **K-472 \$115**.

- 18 Gauge, Seamless Deep Drawn Self Rimming Stainless Steel Bowls.
- Bowls Are Sound Deadened.
- Flat Deck Allowing More Faucet Options.
- Units Feature Advance Tabco's Smart Finish.
- Faucet Optional

SS-1-1715-7  
Shown



SS-1-2321-10  
Shown



SS-2-3321-10  
Shown



### SINGLE BOWL DROP-IN SINKS

Model #	Price	O.A. Size L x W	Bowl Size L x W	Cut-Out Size (1 1/4" Radius Corners)	Wt.	Cu. Ft.
SS-1-1319-10	\$962	13" x 19"	14" x 10" x 10"	12 1/4" x 18 1/4"	14 lbs.	2
SS-1-1715-7	962	17" x 15"	14" x 10" x 7 1/2"	16 1/4" x 14 1/4"	12 lbs.	2
SS-1-1715-10	1071	17" x 15"	14" x 10" x 10"	16 1/4" x 14 1/4"	14 lbs.	3
SS-1-1919-7	1142	19" x 19"	16" x 14" x 7 1/2"	18 1/4" x 18 1/4"	16 lbs.	3
SS-1-1919-10	1207	19" x 19"	16" x 14" x 10"	18 1/4" x 18 1/4"	18 lbs.	4
SS-1-1919-12	1255	19" x 19"	16" x 14" x 12"	18 1/4" x 18 1/4"	20 lbs.	4
SS-1-2321-10	1357	23" x 21"	20" x 16" x 10"	22 1/4" x 20 1/4"	22 lbs.	6
SS-1-2321-12	1443	23" x 21"	20" x 16" x 12"	22 1/4" x 20 1/4"	24 lbs.	6

### DOUBLE BOWL DROP-IN SINKS

SS-2-3321-10	1552	33 1/2" x 21"	14" x 16" x 10"	32 3/4" x 21 1/4"	35 lbs.	6
SS-2-3321-12	1692	33 1/2" x 21"	14" x 16" x 12"	32 3/4" x 21 1/4"	37 lbs.	9
SS-2-4521-10*	1822	45 1/2" x 21"	20" x 16" x 10"	44 3/4" x 21 1/4"	39 lbs.	9
SS-2-4521-12*	1990	45 1/2" x 21"	20" x 16" x 12"	44 3/4" x 21 1/4"	40 lbs.	10



## LAUNDRY ROOM SINK



- 16 Gauge
- Three 4" O.C. Holes\*
- Bowl Size: 24" x 18" x 14"\*\*\*
- Overall Size: 27" x 23"
- Cutout: 26 1/4" x 20 1/4"

**LS-2418-14RE \$2538**

\*\* Requires 30" Wide Countertop (Front to Back)

\*Shown with Faucet Hole Revision **K-472 \$115**

## STAINLESS STEEL SINK GRIDS

- Perforated Grid
- Raised Bottom
- Side Notches for Easy Removal

**K-610 \$672**

(Specify Bowl Size When Ordering)



# UNDERMOUNTS

- 3 1/2" Drain Opening, 1-1/2" IPS Drain
- 1-1/4" Outside Flange



2028A-12 Shown



CO-1014A-10RE Shown



Undermount Bowls are suitable to be welded by others into stainless steel products. Multiple compartment assemblies available. Call for pricing.

Model #	Price	Gauge	Bowl Size LxWxD	Radius	O.D. Trim Size
1014B-05	\$349	20	10" x 14" x 5"	2"	12 1/2" x 16 1/2"
1014A-10	423	20	10" x 14" x 10"	2"	12 1/2" x 16 1/2"
1014A-10A	546	18	10" x 14" x 10"	2"	12 1/2" x 16 1/2"
CO-1014A-10RE*	770	18	10" x 14" x 10"	2"	12 1/2" x 16 1/2"
CO-1416A-10RE*	816	18	14" x 16" x 10"	3"	18 1/2" x 22 1/2"
1620A-10	676	18	16" x 20" x 10"	3"	18 1/2" x 22 1/2"
1620A-12	806	18	16" x 20" x 12"	3"	18 1/2" x 22 1/2"
1620A-14A	997	14	16" x 20" x 14"	3"	18 1/2" x 22 1/2"
1824A-12	1412	18	18" x 24" x 12"	3"	20 1/2" x 26 1/2"
1824A-14A	1584	14	18" x 24" x 14"	3"	20 1/2" x 26 1/2"
2020A-12	902	18	20" x 20" x 12"	3"	22 1/2" x 22 1/2"
2020A-14	973	18	20" x 20" x 14"	3"	22 1/2" x 22 1/2"
2028A-12	1494	16	20" x 28" x 12"	3"	22 1/2" x 30 1/2"
2028A-14A	1679	14	20" x 28" x 14"	3"	22 1/2" x 30 1/2"
2424A-14A	1758	14	24" x 24" x 14"	3"	26 1/2" x 26 1/2"

\* Includes Residential Finish & Packaging. Add **K-350 \$325** for Other Models to Add Residential Finish & Packaging.

**WARNING:** Equipment that includes a faucet may expose you to chemicals, including lead, that are known to the State of California to cause cancer or birth defects or other reproductive harm. For more info., visit [www.p65warnings.ca.gov](http://www.p65warnings.ca.gov).



# HAND SINKS

## Hand Washing Sinks



To delete faucet, order K-590MIT and deduct \$22

= All Sinks On This Page Ship Via UPS



All Sinks on this Page

### STANDARD UNITS

**Bowl Size: 10" x 14" x 5" • Overall Size: 15 1/4" x 17 1/4"** Unless Otherwise Specified  
Includes K-59 Splash Mount Faucet, 3-1/2" Basket Drain & Wall Bracket (Unless Otherwise Specified)



**7-PS-60 \$594**  
Standard Unit  
13 lbs. 2 cu. ft. 20 gauge



**7-PS-68 \$707**  
K-316 Splash Mount  
Wrist Handle Faucet  
13 lbs. 2 cu. ft. 20 gauge



**7-PS-67 \$657**  
Lever Operated  
15 lbs. 2 cu. ft. 20 gauge



**7-PS-50 \$776**  
Lever Operated  
with Overflow & P-Trap  
15 lbs. 2 cu. ft. 20 gauge



**7-PS-54 \$717**  
1 1/2" P-Trap  
15 lbs. 2 cu. ft. 20 gauge



**7-PS-20 \$619**  
K-22 Deck Mount Faucet  
15 lbs. 3 cu. ft. 20 gauge  
**Overall Size:**  
17-1/4" x 17-1/4"

### SIDE SPLASH UNITS

**Bowl Size: 10" x 14" x 5" • Overall Size: 15 1/4" x 17 1/4"** Unless Otherwise Specified  
Includes 7-3/4" High Welded Side Splashes, K-59 Splash Mount Faucet, 3-1/2" Basket Drain & Wall Bracket (Unless Otherwise Specified)



**7-PS-66R or L \$938**  
Right or Left Side Splash  
13 lbs. 2 cu. ft. 20 gauge

Unit Shown:  
7-PS-66R



**7-PS-66 \$1010**  
Standard Unit  
19 lbs. 2 cu. ft. 20 gauge



**7-PS-66W \$1087**  
K-316 Splash Mt. Faucet  
w/ Wrist Handles  
19 lbs. 2 cu. ft. 20 gauge



**7-PS-40 \$1234**  
Lever Operated  
With Overflow & P-Trap  
20 lbs. 2 cu. ft. 20 gauge



**7-PS-76 \$1576**  
Full Length Removable  
Utility Tray  
K-59 Splash Mt. Faucet  
Lever Operated  
With Overflow & P-Trap  
12" High Welded Side Splashes  
24 lbs. 2 cu. ft. 20 gauge



**7-PS-87 \$2039**  
Towel & Soap Dispenser  
K-316 Splash Mt. Faucet  
with Wrist Handles  
Lever Operated  
With Overflow & P-Trap  
34 lbs. 10 cu. ft. 20 gauge

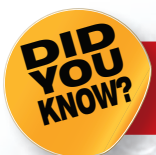

**You Can Add Side Splashes To Any Hand Sink**  
See Page 12

**WARNING:** Equipment that includes a faucet may expose you to chemicals, including lead, that are known to the State of California to cause cancer or birth defects or other reproductive harm. For more info, visit [www.p65warnings.ca.gov](http://www.p65warnings.ca.gov).



**7-PS-73 \$1981**  
7 3/4" High Side Splashes  
Towel Dispenser  
Deck Mt. Soap Dispenser  
K-123 Splash Mt. Faucet  
31 lbs. 5 cu. ft. 20 gauge





All Sinks on this Page



All Sinks On This Page Ship Via UPS

# HAND SINKS

## Hand Washing Sinks

### SOAP & TOWEL DISPENSER UNITS

Bowl Size: 10" x 14" x 5" • Overall Size: 15 1/4" x 17 1/4"

Includes C-Fold Style Towel Dispenser, Liquid Soap Dispenser, K-59 Splash Mount Faucet, 3-1/2" Basket Drain & Wall Bracket (Unless Otherwise Specified)

To delete faucet, order K-590MIT and deduct \$22



**7-PS-69 \$2193**  
K-69 T & S Splash Mounted Faucet  
With Wrist Handles  
Lever Operated With Overflow & P-Trap  
Side Support Brackets  
35 lbs. 6 cu. ft. 20 gauge



**7-PS-79 \$1483**  
Standard Unit  
32 lbs. 10 cu. ft. 20 gauge



**7-PS-80 \$1625**  
Lever Operated  
With Overflow & P-Trap  
32 lbs. 10 cu. ft. 20 gauge

ALL-IN-ONE  
UNIT



**7-PS-85 \$1808**  
P-Trap & Skirt  
35 lbs. 6 cu. ft. 20 gauge

### UNDERMOUNT TOWEL DISPENSER UNITS

**7-PS-41 \$4389**

Tapered Bowl Design  
Hands Free Operated Faucet  
1-1/2" Drain w/ Flat-Top Strainer Plate  
16 Gauge Skirt with Enclosed Bottom  
For Storage w/ Removable Access Panel  
43 lbs. 8 cu. ft. 18 gauge



Available with K-123 "D" Spout  
Splash Mt. Wrist Handle Faucet  
**7-PS-46 \$2912**



**7-PS-65 \$1727**  
Undermount Towel Dispenser  
with Skirt  
Deck Mounted Soap Dispenser  
K-22 Deck Mounted Faucet  
35 lbs. 10 cu. ft. 20 gauge

### 12" WIDE SPACE SAVER UNITS

Bowl Size: 9" x 9" x 5" • Overall Size: 16" x 12"

Includes 2" Drain With Flat Top Strainer & Wall Bracket



**7-PS-22 \$766**  
K-22 Deck Mounted Faucet  
12 lbs. 2 cu. ft. 20 gauge



**7-PS-23 \$800**  
K-123 Splash Mounted Faucet  
12 lbs. 2 cu. ft. 20 gauge



**7-PS-56 \$1225**  
K-123 Splash Mounted Faucet  
8" High Side Splashes  
14 lbs. 2 cu. ft. 20 gauge



**7-PS-88 \$1607**  
Undermount Towel Dispenser  
Deck Mt. Soap Dispenser  
K-22 Deck Mt. Faucet  
23 lbs. 10 cu. ft. 20 gauge



**7-PS-83 \$1502**  
Towel Dispenser  
Deck Mt. Soap Dispenser  
K-22 Deck Mt. Faucet  
27 lbs. 5 cu. ft. 20 gauge



**7-PS-84 \$1566**  
Towel Dispenser  
Deck Mt. Soap Dispenser  
K-123 Splash Mt. Faucet  
27 lbs. 5 cu. ft. 20 gauge



**7-PS-73 \$1981**  
7 3/4" High Side Splashes  
Towel Dispenser  
Deck Mt. Soap Dispenser  
K-123 Splash Mt. Faucet  
31 lbs. 5 cu. ft. 20 gauge

# HANDS-FREE

## Hand Washing Sinks

### HANDS-FREE ELECTRONIC OPERATED FAUCETS

Bowl Size: 10" x 14" x 5" • Overall Size: 15 1/4" x 17 1/4" Includes K-175 AC/DC Powered Electronic Operated Faucet



**7-PS-51 \$2253**

Equal to 7-PS-50 with K-175 Faucet  
21 lbs. 2 cu. ft. 20 gauge



**7-PS-61 \$2072**

Equal to 7-PS-60 with K-175 Faucet  
19 lbs. 2 cu. ft. 20 gauge



**7-PS-81 \$3101**

Equal to 7-PS-80 with K-175 Faucet  
32 lbs. 10 cu. ft. 20 gauge



**7-PS-91 \$2993**

Equal to 7-PS-90 with K-175 Faucet  
41 lbs. 10 cu. ft. 20 gauge

### KNEE VALVE OPERATED FAUCETS

Includes Single Knee Valve (With Built-In Mixing Valve), K-121 Splash Mt. Gooseneck Spout, Skirt, 3-1/2" Basket Drain (Otherwise Noted) & Wall Bracket



**7-PS-30 \$1629**

**Large Bowl Size**  
Bowl Size: 16" (F/B) x 14" x 6"  
Overall : 21-1/4" (F/B) x 17-1/4"  
33 lbs. 8 cu. ft. 18 gauge



**7-PS-62 \$1513**

**Standard Unit**  
Bowl Size: 10" x 14" x 5"  
Overall : 15-1/4" x 17-1/4"  
25 lbs. 2 cu. ft. 20 gauge



**7-PS-59 \$1956**

**Side Splash Unit**  
Bowl Size: 10" x 14" x 5"  
Overall : 15-1/4" x 17-1/4"  
7-3/4" Side Splashes  
31 lbs. 2 cu. ft. 20 gauge



**7-PS-63 \$1513**

**Spacesaver**  
1-1/2" Basket Drain  
Bowl Size: 9" x 9" x 5"  
Overall : 12-1/4" x 16"  
20 lbs. 8 cu. ft. 18 gauge



**7-PS-78 \$1888**

**Large Bowl Size**  
Bowl Size: 16" x 20" x 6"  
Overall : 24-3/4" x 21-7/8"  
40 lbs. 8 cu. ft. 18 gauge



All Sinks on this Page



All Sinks On This Page Ship Via UPS



**7-PS-82 \$2072**

**Towel & Soap Dispenser**  
Bowl Size: 10" x 14" x 5"  
Overall : 15-1/4" x 17-1/4"  
38 lbs. 6 cu. ft. 20 gauge



#### You Can Put A Skirt On Any Handsink

(Excludes sinks with existing bases or skirts. Sinks Not Included)

**7-PS-31 \$485**

Fits Hand Sinks with 10" x 14" Bowl and Splash Mounted Faucets

**7-PS-31A \$524**

Fits Hand Sinks with 9" x 9" Bowl Only

**7-PS-31B \$544**

Fits Hand Sinks with 10" x 14" Bowl and Deck Mounted Faucets



### KNEE & PEDAL VALVE REPLACEMENT PARTS & FAUCETS

#### Foot Pedal Valve Replacement

Combo. H/C  
Single Pedal

**K-103 \$434**

Foot Pedal with Retaining Pin Only

**K-17 \$109**



#### Knee Valve Replacement

Combo. H/C  
Single Pedal

**K-104 \$546**

Knee Pedal with Retaining Pin Only

**K-18 \$109**



#### Foot Pedal Assembly w/Floor Bracket

**7-PS-39 \$583**



#### Knee Valve Assembly w/ Mounting Bracket

**7-PS-32 \$695**



#### Splash Mounted Gooseneck Spout

**K-121 \$128**



#### Replacement Check Valves

**K-19 \$22 set of 2**



#### Mixing Valve & Retainer

**K-19A \$17**



#### Thermostatic Mixing Valve

**K-425 \$389**



#### Replacement Bonnet for Pedal/Knee Valve (K-103 & K-104, 7-PS-32 & 7-PS-39)

**K-01 \$45**





All Sinks on this Page



All Sinks On This Page Ship Via UPS

# HANDS-FREE Hand Washing Sinks

## FOOT PEDAL VALVE UNITS

Includes Single Pedal Valve (With Built-In Mixing Valve), K-121 Splash Mt. Gooseneck Spout, 3-1/2" Basket Drain & Wall Bracket, Removable Panel for Plumbing Access



### 7-PS-90 \$1559

#### Standard Unit

Bowl Size:  
10" x 14" x 5"  
Overall :  
17-1/4" x 15-1/4" x 42"  
41 lbs. 10 cu. ft. 20 gauge



### 7-PS-96 \$1984

#### Side Splash Unit

7-3/4" High Side Splashes  
Bowl Size:  
10" x 14" x 5"  
Overall :  
17-1/4" x 15-1/4" x 42"  
41 lbs. 10 cu. ft. 20 gauge



### 7-PS-18 \$1719

#### Large Bowl Size

Bowl Size:  
16" (F/B) x 14" x 6"  
Overall :  
21-1/4" (F/B) x 17-1/4" x 42"  
50 lbs. 11 cu. ft. 18 gauge



### 7-PS-86 \$1949

#### Extra Large Bowl Size

Bowl Size:  
16" x 20" x 8"  
Overall :  
24-3/4" (F/B) x 21-7/8" x 41-1/2"  
55 lbs. 16 cu. ft. 20 gauge



### 7-PS-99 \$2821

#### Towel & Soap Dispenser

Trash Receptacle  
Bowl Size:  
10" (F/B) x 14" x 5"  
Overall :  
17-1/4" (F/B) x 15-1/4" x 42"  
59 lbs. 15 cu. ft. 20 gauge



### 7-PS-95 \$2266

#### Towel & Soap Dispenser

Bowl Size:  
10" (F/B) x 14" x 5"  
Overall :  
17-1/4" (F/B) x 15-1/4" x 42"  
54 lbs. 15 cu. ft. 20 gauge



## You Can Put a Pedestal Base On Any Hand Sink

(Excludes Sinks With Existing Bases Or Skirts. Sinks Not Included)



### Basic Pedestal Base

#### 7-PS-37 \$543

For 10" x 14" Bowls

#### 7-PS-37B \$680

For 10" x 14" bowls and Deck Mounted Faucets

#### 7-PS-37C \$728

For 16" x 20" Bowls



### With Foot Valve

#### 7-PS-33 \$756

For 10" x 14" Bowls

#### 7-PS-33B \$954

For 10" x 14" Bowls and Deck Mounted Faucets

#### 7-PS-33C \$1030

For 16" x 20" Bowls



### Add Trash Receptacle

#### 7-PS-29 \$616

Use above model number with any Pedestal Base Sink or Stand-Alone Pedestal Base.



Plastic Replacement Handles 7-PS-38 \$37

## SECURITY UNITS

Bowl Size: 10" x 14" x 5" • Require Minimum Security Installations  
Includes Heavy Duty Gooseneck Faucet, Concealed 3 1/2" Drain & Wall Bracket



### 7-PS-747 \$3064

#### Class 2 Upgrade

45 lbs. 10 cu. ft. 20 gauge

### 7-PS-727 \$3893

#### Class 1 Upgrade

Towel Dispenser  
Provisions For Installation Of Soap Dispenser (By Others)  
65 lbs. 15 cu. ft. 20 gauge



# HAND SINKS

## Hand Washing Sinks

**DID YOU KNOW?**

You Can Add a K-175 Electronic Faucet To Any Hand Sink - \$1434



**NSF**

### A.D.A. UNITS FOR THE PHYSICALLY CHALLENGED

All Sinks on this Page

**Bowl Size: 16" x 14" x 5". Overall Size: 20" x 24"**

Includes 1-1/2" Drain With Strainer Plate & Wall Bracket With 2 Side Support Brackets

All Sinks On This Page Ship Via UPS



**7-PS-25 \$1980**

K-208 Deck Mounted Faucet with Wrist Handles  
Deck Mounted Soap Dispenser  
25 lbs. 8 cu. ft. 18 gauge



**7-PS-26 \$3706**

K-180 Hands Free AC/DC Operated Faucet  
Deck Mounted Soap Dispenser  
25 lbs. 8 cu. ft. 18 gauge



**7-PS-75 \$1538**

8" O.C. Faucet Holes  
Faucet Not Included  
25 lbs. 8 cu. ft. 18 gauge

## COUNTERTOP INSTALLED HAND SINKS

For Factory Installation, Add **TA-503** \$417. Can Be Purchased Separately For In-Field Installation

- 4" High Side Splashes
- K-52 Deck Mounted Faucet
- Deck Mounted Soap Dispenser
- Built-In Towel Dispenser
- 3-1/2" Basket Drain



**7-PS-42 \$2538**

Bowl Size: 10" x 14" x 5"  
Overall Size: 18-1/4" x 17-1/4"  
30 lbs. 2 cu. ft. 20 gauge



**7-PS-42A \$2538**

Bowl Size: 9" x 9" x 5"  
Overall Size: 16" x 12"  
26 lbs. 2 cu. ft. 20 gauge

- 4" High Side Splashes
- Deck Mounted Gooseneck Spout
- Knee Operated Valve
- Deck Mounted Soap Dispenser
- Built-In Towel Dispenser
- 3-1/2" Basket Drain



**7-PS-43 \$2938**

Bowl Size: 10" x 14" x 5"  
Overall Size: 18-1/4" x 17-1/4"  
36 lbs. 2 cu. ft. 20 gauge

Knee Valve Operated



## LARGE SIZE SINK BOWLS

Includes K-59 Splash Mt. Gooseneck Faucet, 3-1/2" Basket Drain, Wall Bracket w/ 2 Support Brackets



**7-PS-45 \$1030**

Bowl Size: 16" x 20" x 8"  
Overall Size: 24 3/4" x 21 7/8"  
31 lbs. 8 cu. ft. 18 gauge

**7-PS-49 \$963**

Bowl Size: 14" x 16" x 8"  
Overall Size: 19-1/4" x 19"  
30 lbs. 8 cu. ft. 18 gauge

## SPECIAL PURPOSE UNITS

Bowl Size: 10" x 14" x 5" • Overall Size: 15 1/4" x 17 1/4" (Excludes 7-PS-72 & 7-PS-44)  
Includes 3-1/2" Basket Drain & Wall Bracket

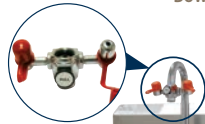

**7-PS-55 \$1079**

Gooseneck Faucet w/ Eye Wash Attachment  
15 lbs. 3 cu. ft. 20 gauge



**7-PS-64 \$963**

Splash Mounted Gooseneck Faucet Tubular Support Brackets  
25 lbs. 2 cu. ft. 20 gauge

PATENTED DESIGN



**7-PS-72 \$1102**

H.A.C.C.P. Compliant Slow Self-Closing Metering Faucet with Mixing Valve  
15 lbs. 3 cu. ft. 20 gauge

Overall Size: 17-1/4" x 17-1/4"



**7-PS-44 \$2529**

Body Activated Valve K-121 Splash Mounted Gooseneck Spout  
28 lbs. 2 cu. ft. 18 gauge

Overall Size: 15-1/4" x 17-1/4"





All Sinks on this Page

All Items On This Page Ship Via UPS

# HAND SINKS

## Hand Washing Sinks & Faucets

### FAUCETS OMITTED

Bowl Size: 10" x 14" x 5". Overall Size: 15 1/4" x 17 1/4"



**7-PS-70 \$542**  
Equal To 7-PS-60 Without Faucet



**7-PS-71 \$596**  
Equal To 7-PS-70 With Single Hole Punch



**7-PS-20-NF \$591**  
Equal To 7-PS-20 Without Faucet



**7-PS-66-NF \$981**  
Equal To 7-PS-66 Without Faucet

### HAND SINK FAUCETS & SPOUTS



**Extra Heavy Duty Splash Mounted Faucet**  
**K-69 \$423**  
4" O.C.



**3-1/2" Splash Mounted Faucet**  
**K-59 \$210**  
4" O.C.

**3-1/2" Splash Mounted Faucet with Wrist Handles**

**K-316 \$323**  
4" O.C.

**Wrist Handles for Faucets**  
**K-316-LU \$109**



**3-1/2" Gooseneck Spouts**

**Deck Mount**  
**K-120 \$215**

**Splash Mounted**  
**K-121 \$128**



**Deck Mounted Faucet**



**K-22 \$190**  
4" O.C.

### ELECTRONIC HANDS FREE FAUCETS



**Splash Mt.**  
**K-175**  
**\$1434**

**Deck Mt.**  
**K-180**  
**\$1434**

Powered by AC or Battery!

**Replacement Control Module**



**K-09**  
**\$648**

**Infra-Red Sensor and Wire Assembly**



**K-14**  
**\$107**

### "D" SPOUT EXTENDED FAUCETS



**Deck Mt. 6" Extended Spout**  
**K-124 \$310**  
4" O.C.



**Deck Mt. w/ Wrist Handles**  
**K-208 \$424**  
4" O.C.



**Splash Mt. 6" Extended Spout**  
**K-123 \$310**  
4" O.C.



**Splash Mt. w/ Wrist Handles**  
**K-206 \$405**  
4" O.C.

### SPECIALTY FAUCETS & ADAPTERS



**Slow-Released Metered Faucet**  
**K-190 \$523**



**Eye-Wash Attachment**  
**K-170 \$428**



**Hands-Free Wand**  
Spout Not Included  
**K-400 \$88 ea.**



**Low Flow Aerator .5 GPM**  
**K-08 \$25**

### REPLACEMENT CARTRIDGES\* (Set of 2)

For Faucets: K-59, K-123, K-125, K-126, K-206 & K-316

**K-00A \$98**

For Faucets: K-1, K-11, K-50, K-51, K-52, K-53, K-56, K-124, K-101, K-159, K-160, K-208 & K-240

**K-00B \$98**



### REPLACEMENT HANDLES\* (Set of 2)

For Splash and Deck Mount Faucets. Set of two. Fits, K-1, K-11, K-50, K-51, K-52, K-53, K-56, K-59, K-101, K-123, K-124, K-125, K-126, K-159, K-160

**K-00C \$66**

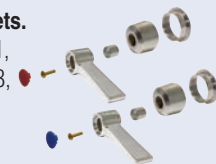

\*Can Only Be Used On Faucets Purchased After January 2016. For Older Faucets, Consult Customer Service.

### REPLACEMENT FAUCET SPOUTS

Model #	Spout Size/Style	For Faucet Model	Price
K-52SP	3-1/2" Swivel Gooseneck	K-52	\$50
K-55SP	8-1/2" Swivel Gooseneck	K-55	81
K-59SP	3-1/2" Swivel Gooseneck	K-59	50
K-208SP	6" Extended Swivel Gooseneck	K-208	57
K-175SP	4-1/2" Swivel Gooseneck	K-175/K-180	50
K-50SP	8" Swing Spout	K-50	56
K-53SP	12" Swing Spout	K-53	75

### Faucet Hole Modifications

Faucet Hole Modification	Faucet Not Included
K-70 Punch for 8" O.C. Faucet Holes	\$120
K-70A Punch for Single Hole Splash Mt. Faucet	\$120
K-71 Punch for Single Hole Deck Mt. Faucet	\$120

# MODS & ACCESSORIES

## Hand Sink Modifications & Accessories

 = Ships Via UPS

### WELDED SIDE SPLASHES FOR HAND SINKS

Factory Installed Only

#### 7-3/4" High Welded Side Splashes



ONE SIDE SPLASH		TWO SIDE SPLASHES		Description
Model #	Price	Model #	Price	
7-PS-16	\$338	7-PS-17	\$430	Units w/ 10" x 14" Bowl & Splash Mount Faucet
7-PS-16A	338	7-PS-17A	441	Units w/ 9" x 9" Bowls
7-PS-16B	359	7-PS-17B	473	Units w/ 10" x 14" Bowl & Deck Mount Faucet
7-PS-16C	369	7-PS-17C	493	Units w/ 16" x 20" Bowls
7-PS-16D	399	7-PS-17D	516	For Handicapped Hand Sinks
7-PS-16E	364	7-PS-17E	483	Units w/ 14" (F/B) x 16" Bowls
7-PS-16F	364	7-PS-17F	483	Units w/ 16" (F/B) x 14" Bowls

#### 12" High Welded Side Splashes

Shown with  
Optional  
Utility Tray



ONE SIDE SPLASH		TWO SIDE SPLASHES		Description
Model #	Price	Model #	Price	
7-PS-11	\$411	7-PS-15	\$464	Units w/ 10" x 14" Bowl & Splash Mount Faucet
7-PS-11A	411	7-PS-15A	464	Units w/ 9" x 9" Bowls
7-PS-11B	443	7-PS-15B	494	Units w/ 10" x 14" Bowl & Deck Mount Faucet
7-PS-11C	464	7-PS-15C	512	Units w/16" x 20" Bowls
7-PS-11D	501	7-PS-15D	570	For Handicapped Hand Sinks
7-PS-11E	491	7-PS-15E	559	Units w/ 14" (F/B) x 16" Bowls
7-PS-11F	491	7-PS-15F	559	Units w/ 16" (F/B) x 14" Bowls

### BOLT-ON SINGLE PANEL SPLASH FOR HAND SINKS

#### 7-3/4" & 12" High Bolt-On Splash

(Priced Per Splash. Order 2 for Both Sides)



Includes Holes.  
Hardware not  
Included

7-3/4" HIGH SPLASH		12" HIGH SPLASH		Description
Model #	Price Ea.	Model #	Price Ea.	
7-PS-27	\$164	7-PS-13	\$212	Units w/ 10" x 14" Bowl & Splash Mount Faucet
7-PS-27A	164	7-PS-13A	212	Units w/ 9" x 9" Bowls
7-PS-27B	164	7-PS-13B	236	Units w/ 10" x 14" Bowl & Deck Mount Faucet
7-PS-27C	164	7-PS-13C	245	Units w/ 16" x 20" Bowls
7-PS-27D	187	7-PS-13D	227	For Handicapped Hand Sinks
7-PS-27E	209	7-PS-13E	225	Units w/ 14" (F/B) x 16" Bowls
7-PS-27F	209	7-PS-13F	225	Units w/ 16" (F/B) x 14" Bowls



7-PS-25 Shown  
With Optional  
Side Splashes.

#### Removable Utility Tray for Side Splashes

- 8" X 3" X 2 5/16" Tray.
- Tray Hem Allows To Hang From Any Standard Side Splash.
- Perforated For Water Drainage.

7-PS-48 \$281 



#### Side Mounting Wall Brackets

Includes 2 brackets. Used for  
Added Strength & Support  
(Add to price of sink)

7-PS-36 \$126 



#### Tubular Wall Supports

Set of 2 Supports

Model #	Price	Description
7-PS-24	\$407	Units w/ 10"x14" Bowl & Splash Mt. Faucet
7-PS-24B	407	Units w/ 10"x14" Bowl & Deck Mt. Faucet
7-PS-24C	476	Units with 16"x14" & 16"x20" Bowls



# MODS & ACCESSORIES

## Hand Sink Modifications & Accessories

 = Ships Via UPS

### Instant Hot Water ON DEMAND

This unit allows for hand sinks to be installed in remote areas with just a cold water supply and available 30 amp electric power. There is no delay or wasted water while waiting for hot water to reach the faucet. Includes Heater & Plumbing Hardware.

7-PS-92 \$2092 

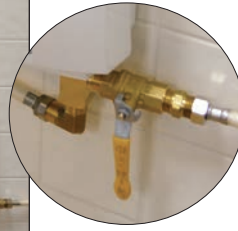

Only 1 Single Supply Line Of Cold Water Is Required To Feed The Unit!

**HANDSINK NOT INCLUDED**

 All items Below Ship Via UPS

### SOAP & TOWEL DISPENSERS



**C-Fold Style Paper Towel & Soap Dispenser**  
Mounts On 17" Wide Hand Sinks Only

7-PS-34 \$985



**Wall Mounted Paper Towel Dispenser**

7-PS-35 \$302



**Wall Mounted Liquid Soap Dispenser**

7-PS-12 \$164



**Wall Mt. Liquid Soap Dispenser**  
Stainless Steel

K-13 \$373



**Deck Mounted Liquid Soap Dispenser**

K-12 \$137

### DRAINS, PARTS & P-TRAPS



1-1/2" IPS

**3-1/2" Basket Drain Assembly**

K-6 \$42



1-1/2" IPS

**2" Drain Assembly w/ Strainer Plate**

K-63 \$34



**Drain Basket For K-6**

K-310 \$26



**Replacement Strainer Plates**

for 3-1/2" Drain for 2" Drain  
K-410 \$23 K-411 \$21



1-1/2" IPS

**Standard Chrome Plated P-Traps**

22 Gauge  
7-PS-14 \$108

17 Gauge  
7-PS-10 \$122



**Replacement Washers for 3-1/2" Drains**

K-67F \$12 (Set of 2)



**K-26 \$146**  
Lever Drain with P-Trap & Overflow

**K-67 \$146**  
Lever Drain Without Overflow

#### REPLACEMENT PARTS FOR K-26 DRAIN



Model #	Description	Price
K-67A	Tail Piece with Overflow Branch Only	\$25
K-67B	Overflow Hose with 2 Spring Clips	15
K-67C	Plastic 90° Overflow Head & Body	12
K-67D	Lever Handle for K-26 Drain	13
K-67E	Plastic Stopper (Includes "O" Ring)	12



# MOP SINKS





## Floor Mop Sinks

 = Ships Via UPS

**CUSTOM SIZES AVAILABLE**



### FLOOR UNITS Mounting Hardware Included

Model #	Bowl Size	Overall Dimension	Price	Approx. Wt.	Approx. Cu.
<b>STANDARD MOP SINKS</b>					
9-OP-20	16" x 20" x 6"	21" x 25"	<b>\$1315</b>	26 lbs.	5 
9-OP-28	20" x 28" x 6"	25" x 33"	<b>1703</b>	35 lbs.	5 
9-OP-40	16" x 20" x 12"	21" x 25"	<b>1578</b>	45 lbs.	7 
9-OP-48	20" x 28" x 12"	25" x 33"	<b>1862</b>	63 lbs.	9 
<b>LARGE MOP SINK BOWL</b>					
9-OP-44	24" x 24" x 12"	29" x 29"	<b>2334</b>	70 lbs.	9
<b>DROP-FRONT MOP SINKS</b>					
9-OP-40DF	16" x 20" x 12"	18 1/2" x 25"	<b>2488</b>	45 lbs.	7 
9-OP-48DF	20" x 28" x 12"	22 1/2" x 33"	<b>2769</b>	63 lbs.	9



Notched Out Front Allows Ease of Emptying Mop Bucket

### Flush-Mount Floor Mop Sink

- Easy Mop Bucket Roll-In Design
- Standard Backsplash with Left & Right Splash, Left Splash or Right Splash Available
- 4" O.D. - 3" Long Plumbing Sleeve
- Front Anti-Splash Guard
- Removable Subway Grating
- Stainless Steel Strainer Basket with Handle

**FT-2 \$55 ea.**  
Replacement Stainless Steel Strainer Basket with Handle for Flush-Mount Floor Mop Sinks



WITH STAINLESS STEEL GRATES			WITH FIBERGLASS GRATES			Bowl Size	Overall Dimension	Splash Locations	Approx. Cu.
Model #	Approx. Wt.	Price	Model #	Approx. Wt.	Price				
9-OP-24FM-SSRL	128 lbs.	<b>\$4201</b>	9-OP-24FM-FGRL	96 lbs.	<b>\$4201</b>	21 3/8" x 22 x 10"	21 3/8" x 24"	Back, Left & Right	14
9-OP-24FM-SSL	120 lbs.	<b>4058</b>	9-OP-24FM-FGL	88 lbs.	<b>4058</b>	21 3/8" x 22 x 10"	21 3/8" x 24"	Back & Left	14
9-OP-24FM-SSR	120 lbs.	<b>4058</b>	9-OP-24FM-FGR	88 lbs.	<b>4058</b>	21 3/8" x 22 x 10"	21 3/8" x 24"	Back & Right	14

**DID YOU KNOW?**

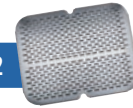

You Can Use a K-610 Removable Stainless Steel Sink Grid In A Floor Mop Sink - \$672





### 16" HIGH SIDE & BACK SPLASHES FOR FLOOR MOP SINKS

16 Gauge, 300 Series Stainless Steel

#### Splashes on All 3 Sides

Model #	Fits Units:	Model #	Fits Units:	Price
K-298	9-OP-20 9-OP-40	K-298D	9-OP-40DF	<b>\$896</b> 
K-299	9-OP-28 9-OP-48	K-299D	9-OP-48DF	<b>982</b> 
K-300	9-OP-44	-	-	<b>1162</b> 

#### Splash on Left or Right & Back

Model #	Fits Units:	Model #	Fits Units:	Price
K-288LorR	9-OP-20 9-OP-40	K-288LorRD	9-OP-40DF	<b>\$569</b> 
K-290LorR	9-OP-28 9-OP-48	K-290LorRD	9-OP-48DF	<b>602</b> 
K-291LorR	9-OP-44	-	-	<b>826</b> 



Height Above Finished Floor (A.F.F.)

9-OP-20/9-OP-28 = 26" High 9-OP-40/9-OP-40DF/9-OP-44/9-OP-48/ 9-OP-48DF = 32" High

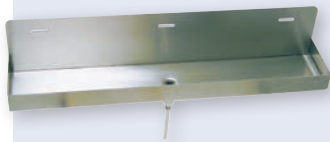

#### Wall Mounted Drainage Tray K-243 \$438

- Used with Floor Mounted Mop Sinks
- 16 Gauge, 300 Series Stainless Steel
- Includes 1/2" Drain & Plastic Hose
- 2" Tray Ht. with 6" Rear Splash (O.A.)
- 20" x 4" x 6". 13 lbs.



**Hose & Hanger**  
K-244 **\$191**



**23" Mop Hanger**  
K-242 **\$209**



Fabricated Sink Bowl



Deep Drawn Sink Bowl

### STANDING SERVICE SINKS

Heavy Gauge Stainless Steel • 8" Bowl Depth • 8" High Backsplash • Stainless Steel Legs with Adjustable Bullet Feet  
• 8-OP-16 Includes Stainless Steel Cross-Bracing • 8" O.C. Faucet Holes • 3-1/2" Basket Drain

Model #	Bowl Size	Overall Dimension	Price	Approx. Wt.	Approx. Cu.
8-OP-16	16" x 20" x 8"	25" x 23"	<b>\$1451</b>	50 lbs.	13 
4-OP-18	24" x 21" x 8"	24" x 25"	<b>990</b>	50 lbs.	10



# MOP SINKS

## Mop Sink Cabinets

84" HIGH STAINLESS STEEL MOP SINK CABINETS  = Ships Via UPS



### Single Width

- Single Left-Hinged Door\*
- 1 Fixed Stainless Steel Mid-Shelf
- Ventilation Slots
- 2 Mop Holders
- Open Back For Plumbing
- 16 Ga., Type 304 S/S Mop Sink & Drain

16" x 20" x 12" Bowl  
Overall Size: 22-5/8" x 25" x 84"



### Double Width



- Hinged Double Doors
- Opening For Mop Bucket To Roll In
- 4 Fixed Stainless Steel Mid-Shelves (3 In Storage Side, 1 Above Sink)
- Enclosed Back Panel
- Ventilation Slots
- 2 Mop Holders
- Open Back For Plumbing
- 16 Ga., Type 304 S/S Mop Sink & Drain

16" x 20" x 12" Bowl  
Overall Size: 22-5/8" x 50-1/4" x 84"

9-OPC-84DR Shown

Model #	Cabinet Material	Price	Approx. Wt.	Approx. Cu.
9-OPC-84	18 Ga., 430 S/S	\$6520	238 lbs.	40
9-OPC-84-300	18 Ga., 300 S/S	7607	238 lbs.	40

\*Optional Right-Hand Door Swing Available - Add CAB-R N/C

Model #	Cabinet Material	Price	Approx. Wt.	Approx. Cu.
9-OPC-84DR	18 Ga., 430 S/S	\$8911	390 lbs.	72
9-OPC-84DL	18 Ga., 430 S/S	8911	390 lbs.	72
9-OPC-84DR-300	18 Ga., 300 S/S	9345	390 lbs.	72
9-OPC-84DL-300	18 Ga., 300 S/S	9345	390 lbs.	72

R And L Indicates Mop Sink Location.

### Stainless Steel Cabinet with Floor



Sink Not Included

- Overall Size: 22-5/8" x 25" x 84"
- Single Left-Hinged Door\*
- Fixed Stainless Steel Mid-Shelves
- Enclosed Back Panel
- Ventilation Slots On Both Sides

Model #	# of Fixed Shelves	Price	Approx. Wt.	Approx. Cu.
18 Ga. CAB-1	1	\$4781	200 lbs.	40
430 S/S CAB-4	4	5542	240 lbs.	40
18 Ga. CAB-1-300	1	5216	200 lbs.	40
300 S/S CAB-4-300	4	6085	240 lbs.	40

\*Optional Right-Hand Door Swing Available - Add CAB-R N/C



### CHEMICAL STORAGE CABINET

w/ 1 Fixed Stainless Steel Mid-Shelf



Vented Side Panels

WCH-15-24 Left Hinged Shown (Standard)

- Left-Hinged Door\*
- Vented Side Panels
- Wall Mounting Hardware Not Included

**WCH-15-24 \$4021**

18 Gauge, 430 Stainless Steel

**WCH-15-24-300 \$4455**

18 Gauge, 300 Stainless Steel

\*Optional Right-Hand Door Swing Available - Add CAB-R N/C

Overall Size: 15" x 24" x 32-1/2"

## MOP SINK CABINET ACCESSORIES & MODIFICATIONS



### Service Faucet For Mop Sinks

8" O.C.

**K-240\* \$835** 

\*K-240 Does Not Meet Federal Lead Free Standards As It Is Not Intended For Potable Water.



### Service Faucet Vacuum Breaker Repair Kit

**K-03 \$116** 



### Mop Sink Replacement Drain

**K-16 \$161** 

### Double Cabinet Doors

Convert Single Width Cabinet to Double Doors

**K-84-CAB \$641**



### Add Rear Panel To Cabinet

**K-94-BACK \$441**  
**K-94-BACK-300 \$638**

Add **K-472** for 8" O.C. Faucet Holes \$115 Per Hole



### Additional Fixed Mid-Shelf

**K-94-SHELF \$338 ea.**  
For 84" High Cabinets

**WC-SHELF \$82 lin. ft.**  
For Wall Cabinets

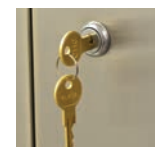

### Cabinet Door Lock

**TA-46 \$283**

Required For Each Hinged Door

# MULTI-STATIONS

## NSF Multi-Stations



= Ships Via UPS

### 14 GAUGE, 304 STAINLESS STEEL SINKS WITH TUBULAR SUPPORTS OR LEGS

8" Bowl Depth • 8 1/2" High Backsplash • 8" O.C. Faucet Holes on Manual Operated, Single Holes on Knee/Toe-Push or Electronic Operated • 3 1/2" Basket Drain(s)



Manual Operated  
(Faucet Not Included)

Toe-Push Valve

FS-WM-40 Shown

FS-WM-40EF Shown

FS-WM-40KV Shown

FS-WM-40FV Shown

L	MANUAL FAUCET OPERATED		ELECTRONIC OPERATED		KNEE OPERATED		TOE-PUSH OPERATED		# of Faucets	Wt.	Cu. Ft.
	Model #	Price	Model #	Price	Model #	Price	Model #	Price			
40"	FS-WM-40 <sup>†</sup>	\$3896	FS-WM-40EF	\$6115	FS-WM-40KV	\$5102	FS-WM-40FV**	\$5345	2	72 lbs.	15
60"	FS-WM-60 <sup>†</sup>	4333	FS-WM-60EF	7656	FS-WM-60KV	6137	FS-WM-60FV**	6316	3	84 lbs.	18
80"	FS-WM-80 <sup>†</sup>	4912	FS-WM-80EF	9343	FS-WM-80KV	7317	FS-WM-80FV**	7486	4	120 lbs.	22
100"	FS-WM-100 <sup>†</sup>	5387	FS-WM-100EF	10926	FS-WM-100KV	8394	FS-WM-100FV**	8552	5	156 lbs.	30
120"	FS-WM-120 <sup>†</sup>	6792	FS-WM-120EF	13439	FS-WM-120KV	10400	FS-WM-120FV**	10537	6	198 lbs.	36

<sup>†</sup>Add K-472 For Faucet Hole Revision \$115

\*\*Toe-Push Operated Sinks Include Wall Bracket & Are Floor Mounted



### 14 GAUGE, 304 STAINLESS STEEL A.D.A. SINKS WITH TUBULAR SUPPORTS

5" Bowl Depth • 8 1/2" High Backsplash • 8" O.C. Faucet Holes on Manual Operated or Single Holes on Electronic Faucet Operated • Rear 3 1/2" Basket Drain(s)

L	MANUAL FAUCET OPERATED		ELECTRONIC OPERATED		# of Faucets	Wt.	Cu. Ft.
	Model #	Price	Model #	Price			
40"	FS-WM-40-ADA <sup>†</sup>	\$3781	FS-WM-40EFADA	\$5997	2	72 lbs.	15
60"	FS-WM-60-ADA <sup>†</sup>	4205	FS-WM-60EFADA	7528	3	84 lbs.	18
80"	FS-WM-80-ADA <sup>†</sup>	4764	FS-WM-80EFADA	9195	4	120 lbs.	22
100"	FS-WM-100-ADA <sup>†</sup>	5226	FS-WM-100EFADA	10765	5	156 lbs.	30
120"	FS-WM-120-ADA <sup>†</sup>	6682	FS-WM-120EFADA	13329	6	198 lbs.	36

<sup>†</sup>Add K-472 For Faucet Hole Revision \$115



FS-WM-40-ADA Shown

FS-WM-40EFADA Shown

### 16 GAUGE, 304 STAINLESS STEEL SINKS WITH TUBULAR SUPPORTS OR LEGS

8" Bowl Depth • 8 1/2" High Backsplash • 8" O.C. Faucet Holes on Manual Operated, Single Holes on Knee/Toe-Push or Electronic Operated • 3 1/2" Basket Drain(s)

L	MANUAL FAUCET OPERATED		ELECTRONIC OPERATED		KNEE OPERATED		TOE-PUSH OPERATED		# of Faucets	Wt.	Cu. Ft.
	Model #	Price	Model #	Price	Model #	Price	Model #	Price			
40"	FC-WM-40 <sup>†</sup>	\$3369	FC-WM-40EF	\$5584	FC-WM-40KV	\$4571	FC-WM-40FV**	\$4814	2	66 lbs.	15
60"	FC-WM-60 <sup>†</sup>	3803	FC-WM-60EF	7127	FC-WM-60KV	5607	FC-WM-60FV**	5787	3	77 lbs.	18
80"	FC-WM-80 <sup>†</sup>	4455	FC-WM-80EF	8886	FC-WM-80KV	6861	FC-WM-80FV**	7029	4	110 lbs.	22
100"	FC-WM-100 <sup>†</sup>	4999	FC-WM-100EF	10537	FC-WM-100KV	8005	FC-WM-100FV**	8164	5	143 lbs.	30
120"	FC-WM-120 <sup>†</sup>	5977	FC-WM-120EF	12623	FC-WM-120KV	9585	FC-WM-120FV**	9722	6	182 lbs.	36

<sup>†</sup>Add K-472 For Faucet Hole Revision \$115

\*\*Toe-Push Operated Sinks Include Wall Bracket & Are Floor Mounted



### 16 GAUGE, 304 STAINLESS STEEL A.D.A. SINKS WITH TUBULAR SUPPORTS

5" Bowl Depth • 8 1/2" High Backsplash • 8" O.C. Faucet Holes on Manual Operated or Single Holes on Electronic Faucet Operated • Rear 3 1/2" Basket Drain(s)

L	MANUAL FAUCET OPERATED		ELECTRONIC OPERATED		# of Faucets	Wt.	Cu. Ft.
	Model #	Price	Model #	Price			
40"	FC-WM-40-ADA <sup>†</sup>	\$3303	FC-WM-40EFADA	\$5519	2	66 lbs.	15
60"	FC-WM-60-ADA <sup>†</sup>	3695	FC-WM-60EFADA	7018	3	77 lbs.	18
80"	FC-WM-80-ADA <sup>†</sup>	4238	FC-WM-80EFADA	8669	4	110 lbs.	22
100"	FC-WM-100-ADA <sup>†</sup>	4890	FC-WM-100EFADA	10429	5	143 lbs.	30
120"	FC-WM-120-ADA <sup>†</sup>	5868	FC-WM-120EFADA	12514	6	182 lbs.	36

<sup>†</sup>Add K-472 For Faucet Hole Revision \$115 Manual Operated (Faucet Not Included)



FC-WM-40-ADA Shown

FC-WM-40EFADA Shown

 = Ships Via UPS



# SERVICE SINKS

## NSF Service Sinks

### 14 GAUGE, 304 STAINLESS STEEL SERVICE SINKS WITH TUBULAR SUPPORTS OR LEGS

10" or 12" Bowl Depth • 8-1/2" High Backsplash • 8" O.C. Faucet Holes on Manual Operated, Single Holes on Knee/Toe-Push or Electronic Operated • 3 1/2" Basket Drain(s)

Manual Operated  
(Faucet Not Included)



FS-WM-2219 Shown



FS-WM-2219EF Shown



FS-WM-2219KV Shown



FS-WM-2219FV Shown



Toe-Push Valve

MANUAL FAUCET OPERATED		ELECTRONIC OPERATED		KNEE OPERATED		TOE-PUSH OPERATED		Bowl Depth	L	W	Wt.	Cu. Ft.
Model #	Price	Model #	Price	Model #	Price	Model #	Price					
FS-WM-2219 <sup>†</sup>	\$2104	FS-WM-2219EF	\$3211	FS-WM-2219KV*	\$2705	FS-WM-2219FV**	\$3011	*10"	23"	19 1/2"	62 lbs.	10
FS-WM-2721 <sup>†</sup>	2238	FS-WM-2721EF	3345	FS-WM-2721KV*	2839	FS-WM-2721FV**	3145	12"	27"	21 1/2"	77 lbs.	13

<sup>†</sup>Add **K-472** For Faucet Hole Revision **\$115** \*FS-WM-2219KV & FS-WM-2721KV Has 8" Bowl Depth \*\*Foot Valve Units include Wall Mounting Bracket & stands on the floor



### 14 GAUGE, 304 STAINLESS STEEL A.D.A. SERVICE SINKS WITH TUBULAR SUPPORTS

5" Bowl Depth • 8-1/2" High Backsplash • Stainless Steel Tubular Supports • 8" O.C. Faucet Holes on Manual Operated, Single Hole on Electronic Operated • 3 1/2" Basket Drain

MANUAL FAUCET OPERATED		ELECTRONIC OPERATED		Bowl Depth	L	W	Wt.	Cu. Ft.
Model #	Price	Model #	Price					
FS-WM-1-ADA <sup>†</sup>	\$3483	FS-WM-1-EFADA	\$4590	6"	40"	19-1/2"	72 lbs.	15

Manual Operated (Faucet Not Included)

<sup>†</sup>Add **K-472** For Faucet Hole Revision **\$115**



FS-WM-1-EFADA Shown

### 16 GAUGE, 304 STAINLESS STEEL SERVICE SINKS WITH TUBULAR SUPPORTS OR LEGS

10" or 12" Bowl Depth • 8-1/2" High Backsplash • 8" O.C. Faucet Holes on Manual Operated, Single Holes on Knee/Toe-Push or Electronic Operated • 3 1/2" Basket Drain(s)

Manual Operated  
(Faucet Not Included)



FC-WM-2219 Shown



FC-WM-2219EF Shown



FC-WM-2219KV Shown



Knee Valve



FC-WM-2219FV Shown



Toe-Push Valve

MANUAL FAUCET OPERATED		ELECTRONIC OPERATED		KNEE OPERATED		TOE-PUSH OPERATED		Bowl Depth	L	W	Wt.	Cu. Ft.
Model #	Price	Model #	Price	Model #	Price	Model #	Price					
FC-WM-2219 <sup>†</sup>	\$1868	FC-WM-2219EF	\$2976	FC-WM-2219KV*	\$2470	FC-WM-2219FV**	\$2776	*10"	23"	19 1/2"	57 lbs.	10
FC-WM-2721 <sup>†</sup>	1967	FC-WM-2721EF	3074	FC-WM-2721KV*	2568	FC-WM-2721FV**	2874	12"	27"	21 1/2"	70 lbs.	13

<sup>†</sup>Add **K-472** For Faucet Hole Revision **\$115** \*FC-WM-2219KV & FC-WM-2721KV Has 8" Bowl Depth \*\*Toe-Push Operated Sinks Include Wall Bracket & Are Floor Mounted



### 16 GAUGE, 304 STAINLESS STEEL A.D.A. SERVICE SINKS WITH TUBULAR SUPPORTS

5" Bowl Depth • 8-1/2" High Backsplash • Stainless Steel Tubular Supports • 8" O.C. Faucet Holes on Manual Operated, Single Hole on Electronic Operated • 3 1/2" Basket Drain

MANUAL FAUCET OPERATED		ELECTRONIC OPERATED		Bowl Depth	L	W	Wt.	Cu. Ft.
Model #	Price	Model #	Price					
FC-WM-1-ADA <sup>†</sup>	\$3303	FC-WM-1-EFADA	\$4411	6"	27"	21 1/2"	66 lbs.	13

Manual Operated (Faucet Not Included)

<sup>†</sup>Add **K-472** For Faucet Hole Revision **\$115**



FC-WM-1-ADA Shown

**WARNING:** Equipment that include faucets on this page may contain a chemical known to the State of California to cause cancer, birth defects or other reproductive harm.

# MULTI-STATIONS

## Square Corner Multi-Stations

 = Ships Via UPS

### 16 GAUGE, 304 STAINLESS STEEL MULTI-STATIONS WITH TUBULAR SUPPORTS OR LEGS

8" Bowl Depth • 8 1/2" High Backsplash • 8" O.C. Faucet Holes on Manual Operated, Single Holes on Knee/Toe-Push or Electronic Operated • 3 1/2" Basket Drain(s)



L	MANUAL FAUCET OPERATED		ELECTRONIC OPERATED		KNEE OPERATED		TOE-PUSH OPERATED		# of Faucets	Wt.	Cu. Ft.
	Model #	Price	Model #	Price	Model #	Price	Model #	Price			
23"	19-18-23 <sup>†</sup>	\$1691	19-18-23EF	\$2862	19-18-23KV	\$2356	19-18-23FV**	\$2662	1	50 lbs.	10
40"	19-18-40 <sup>†</sup>	2718	19-18-40EF	4933	19-18-40KV	3920	19-18-40FV**	4163	2	60 lbs.	15
60"	19-18-60 <sup>†</sup>	3211	19-18-60EF	6535	19-18-60KV	5015	19-18-60FV**	5195	3	70 lbs.	18
80"	19-18-80 <sup>†</sup>	3581	19-18-80EF	8012	19-18-80KV	5986	19-18-80FV**	6155	4	90 lbs.	22
100"	19-18-100 <sup>†</sup>	4075	19-18-100EF	9614	19-18-100KV	7082	19-18-100FV**	7240	5	120 lbs.	30
120"	19-18-120 <sup>†</sup>	5097	19-18-120EF	11743	19-18-120KV	8705	19-18-120FV**	8842	6	155 lbs.	36

<sup>†</sup>Add **K-472** For Faucet Hole Revision **\$115**

\*\*Toe-Push Operated Sinks Include Wall Bracket & Are Floor Mounted



### 16 GAUGE, 304 STAINLESS STEEL A.D.A. MULTI-STATIONS WITH TUBULAR SUPPORTS

5" Bowl Depth • 8 1/2" High Backsplash • 8" O.C. Faucet Holes on Manual Operated or Single Holes on Electronic Faucet Operated • Rear 3 1/2" Basket Drain(s)

Manual Operated (Faucet Not Included)



L	MANUAL FAUCET OPERATED		ELECTRONIC OPERATED		# of Faucets	Wt.	Cu. Ft.
	Model #	Price	Model #	Price			
40"	19-18-40-ADA <sup>†</sup>	\$2718	19-18-40EFADA	\$4933	2	60 lbs.	15
60"	19-18-60-ADA <sup>†</sup>	3211	19-18-60EFADA	6492	3	70 lbs.	18
80"	19-18-80-ADA <sup>†</sup>	3581	19-18-80EFADA	8012	4	100 lbs.	22
100"	19-18-100-ADA <sup>†</sup>	4075	19-18-100EFADA	9614	5	130 lbs.	30
120"	19-18-120-ADA <sup>†</sup>	5097	19-18-120EFADA	11743	6	165 lbs.	36

<sup>†</sup>Add **K-472** For Faucet Hole Revision **\$115**



# SERVICE SINKS

## Square Corner Service Sinks

### 16 GAUGE, 304 STAINLESS STEEL SERVICE SINKS WITH TUBULAR SUPPORTS OR LEGS

12" Bowl Depth (Excludes Knee Valve Units\*) • 8 1/2" High Backsplash • 8" O.C. Faucet Holes on Manual Operated, Single Holes on Knee/Toe-Push or Electronic Operated • 3 1/2" Basket Drain(s)

Manual Operated  
(Faucet Not Included)



WSS-14-21 Shown



WSS-14-21EF Shown



WSS-14-21KV Shown



Knee Valve



WSS-14-21FV Shown



Toe-Push Valve

MANUAL FAUCET OPERATED		ELECTRONIC OPERATED		KNEE OPERATED		TOE-PUSH OPERATED				Cu.	
Model #	Price	Model #	Price	Model #	Price	Model #	Price	L	W	Wt.	Ft.
WSS-14-21 <sup>†</sup>	\$1779	WSS-14-21EF	\$2886	WSS-14-21KV*	\$2380	WSS-14-21FV**	\$2686	18"	17 1/2"	45 lbs.	8
WSS-16-25 <sup>†</sup>	1964	WSS-16-25EF	3072	WSS-16-25KV*	2566	WSS-16-25FV**	2872	22"	19 1/2"	52 lbs.	10

<sup>†</sup>Add **K-472** For Faucet Hole Revision **\$115**

\*Knee Valve Unit Has 8" Bowl Depth

\*\*Toe-Push Operated Sinks Include Wall Bracket & Are Floor Mounted



### 16 GAUGE, 304 STAINLESS STEEL A.D.A. SERVICE SINKS WITH TUBULAR SUPPORTS

5" Bowl Depth • 8 1/2" High Backsplash • 8" O.C. Faucet Holes on Manual Operated, Single Holes on Electronic Operated • Rear 3 1/2" Basket Drain

Manual Operated  
(Faucet Not Included)



19-18-1-ADA Shown



19-18-1-EFADA Shown



Hands-Free Electronic Faucet

MANUAL FAUCET OPERATED		ELECTRONIC OPERATED				Cu.	
Model #	Price	Model #	Price	L	W	Wt.	Ft.
19-18-1-ADA <sup>†</sup>	\$2716	19-18-1-EFADA	\$3771	40"	19 1/2"	60 lbs.	15

<sup>†</sup>Add **K-472** For Faucet Hole Revision **\$115**

### MULTI-STATION HAND SINK ACCESSORIES & MODIFICATIONS

Model	Description	Price
K-6	3 1/2" Drain (1 1/2" I.P.S.)	\$42 ea.
K-13	Stainless Steel Soap Dispenser	373 ea.
K-101	8" Swing Spout Splash Mt. Faucet	205 ea.
K-121	Single Hole, Splash Mounted 3-1/2" Gooseneck Spout	128 ea.
K-159	Splash Mounted 3-1/2" Gooseneck Faucet (8" O.C.)	236 ea.
K-411	Strainer Plate for 3-1/2" Drain	21 ea.
K-1118	Extra H.D. 8" Splash Mounted Faucet	349 ea.
K-316-LU	Wrist Handles	109 pair
K-472	Faucet Hole Revision (Manual Faucet Operated Sinks Only)	115
K-508	Special Sizing Charge (Larger Size Cut Down To Smaller Size)	N/C
TA-19	Adjustable Stainless Steel Flanged Bullet Foot	53 ea.

#### FLOOR STANDING LEGS MODIFICATION

Converts Wall Mounted WSS, FC-WM, FS-WM & 19-18 Series Sinks To Free Standing Floor Units.

- Stainless Steel Legs with Flanged Feet
- Welded Side Bracing
- Rear Adjustable Cross Bracing

Model #	Fits Sink Length	Price
FS-CB-23	23"	\$390
FS-CB-40	40"	396
FS-CB-60	60"	494
FS-CB-80	80"	593
FS-CB-100	100"	791
FS-CB-120	120"	990



Rear Cross Bracing should not be installed when adding legs to an ADA Compliant Sink.

# REGALINE

## Deep Drawn Sinks

ALL MODELS INCLUDE  
STAINLESS STEEL LEGS  
& BULLET FEET



Deep Drawn Bowls Are Seamless And  
Drawn Out of a Single Sheet of Steel

### Features and Benefits

- 3" Large Radius Corners
- Easy to Clean
- Satin Finish
- No Welded Seams



### SPEC-LINE "94" Series

- 14 ga. 304 Stainless Steel
- Stainless Steel Adjustable Cross Bracing on Front & Rear; Welded On Sides
- 16 ga. 304 Stainless Steel Legs & Bullet Feet
- 11" Backsplash
- 14" Deep Sink Bowls

THE ONLY  
14 GAUGE  
Deep Drawn  
SINK!

### STANDARD "93" Series

- 16 ga. 304 Stainless Steel
- Stainless Steel Welded Side Cross Bracing
- Stainless Steel Legs and Bullet Feet
- 8" Backsplash
- 12" Deep Sink Bowls

### SUPERSAVER "9" Series

- 18 ga. 304 Stainless Steel
- Stainless Steel Welded Side Cross Bracing
- Stainless Steel Legs and Bullet Feet
- 8" Backsplash
- 12" Deep Sink Bowls

## ONE, TWO, THREE AND FOUR COMPARTMENTS with No Drainboards



94 Series Shown

### Spec-Line 94 Series

### Standard 93 Series

### Super Saver 9 Series

Bowl Size	O.A. Length	# of Comp.	14 Ga. 304 S/S 14" Water Level			16 Ga. 304 S/S 12" Water Level			18 Ga. 304 S/S 12" Water Level			Cu. Ft.
			Model #	Price	Approx. Wt. (lbs.)	Model #	Price	Approx. Wt. (lbs.)	Model #	Price	Approx. Wt. (lbs.)	
16" x 20"	25"	One	94-1-24	\$3510	77	93-1-24	\$2281	62	9-1-24	\$2092	54	20
	44"	Two	94-2-36	4554	109	93-2-36	3127	76	9-2-36	2866	66	20
	62"	Three	94-3-54	5628	142	93-3-54	3958	107	9-3-54	3629	95	28
	*81"	Four	94-4-72	7195	225	93-4-72	5118	176	9-4-72	4697	155	44
20" x 20"	29"	One	94-21-20	3834	92	93-21-20	2486	80	9-21-20	2449	61	20
	52"	Two	94-22-40	5000	116	93-22-40	3440	92	9-22-40	3154	79	23
	74"	Three	94-23-60	6437	232	93-23-60	4561	188	9-23-60	4180	169	44
	*97"	Four	94-24-80	8090	285	93-24-80	5826	210	9-24-80	5358	192	56
18" x 24"	27"	One	94-61-18	3988	95	93-61-18	2673	84	9-61-18	2469	78	24
	48"	Two	94-62-36	5114	165	93-62-36	3601	144	9-62-36	3326	132	26
	68"	Three	94-63-54	6513	249	93-63-54	4687	203	9-63-54	4319	188	36
	89"	Four	94-64-72	8118	312	93-64-72	5916	264	9-64-72	5465	255	56
24" x 24"	33"	One	94-41-24	4108	97	93-41-24	2881	85	9-41-24	2643	80	23
	60"	Two	94-42-48	5944	174	93-42-48	4341	145	9-42-48	3981	133	31
	*86"	Three	94-43-72	7488	252	93-43-72	5684	213	9-43-72	5213	200	56
	*113"	Four	94-44-96	9307	347	93-44-96	7294	302	9-44-96	6684	281	74
20" x 28"	29"	One	94-81-20	4528	134	93-81-20	2998	94	9-81-20	2740	82	27
	52"	Two	94-82-40	5958	176	93-82-40	4404	150	9-82-40	4035	138	45
	74"	Three	94-83-60	7713	255	93-83-60	5878	225	9-83-60	5388	216	65
	*97"	Four	94-84-80	9843	345	93-84-80	7601	310	9-84-80	6959	287	78



# REGALINE

## Deep Drawn Sinks



94 Series Shown

### ONE COMPARTMENT WITH TWO DRAINBOARDS

#### Spec-Line 94 Series

#### Standard 93 Series

#### Super Saver 9 Series

14 Ga. 304 S/S 14" Water Level	16 Ga. 304 S/S 12" Water Level	18 Ga. 304 S/S 12" Water Level
-----------------------------------	-----------------------------------	-----------------------------------

Bowl Size	O.A. Length	DRBD. Size	Model #	Price	Approx. Wt. (lbs.)	Model #	Price	Approx. Wt. (lbs.)	Model #	Price	Approx. Wt. (lbs.)	Cu. Ft.
<b>16" x 20"</b>	54"	18"	94-1-24-18RL	\$3765	97	93-1-24-18RL	\$3275	82	9-1-24-18RL	\$3106	71	29
	66"	24"	94-1-24-24RL	3914	118	93-1-24-24RL	3380	95	9-1-24-24RL	3125	95	33
	90"	36"	94-1-24-36RL	4304	164	93-1-24-36RL	3626	134	9-1-24-36RL	3318	134	48
<b>20" x 20"</b>	58"	18"	94-21-20-18RL	4135	95	93-21-20-18RL	3588	78	9-21-20-18RL	3262	78	26
	70"	24"	94-21-20-24RL	4267	117	93-21-20-24RL	3619	92	9-21-20-24RL	3333	92	34
	94"	36"	94-21-20-36RL	4840	168	93-21-20-36RL	3843	147	9-21-20-36RL	3705	147	50
<b>18" x 24"</b>	56"	18"	94-61-18-18RL	4276	160	93-61-18-18RL	3744	138	9-61-18-18RL	3428	138	29
	68"	24"	94-61-18-24RL	4405	179	93-61-18-24RL	3776	150	9-61-18-24RL	3498	150	43
	92"	36"	94-61-18-36RL	4956	210	93-61-18-36RL	3994	180	9-61-18-36RL	3863	180	67
<b>24" x 24"</b>	74"	24"	94-41-24-24RL	4946	213	93-41-24-24RL	4395	185	9-41-24-24RL	4081	185	48
	98"	36"	94-41-24-36RL	5791	252	93-41-24-36RL	4569	210	9-41-24-36RL	4269	210	64
<b>20" x 28"</b>	58"	18"	94-81-20-18RL	4897	173	93-81-20-18RL	4435	150	9-81-20-18RL	4129	150	46
	70"	24"	94-81-20-24RL	5030	186	93-81-20-24RL	4569	165	9-81-20-24RL	4264	165	55
	94"	36"	94-81-20-36RL	6330	225	93-81-20-36RL	4708	195	9-81-20-36RL	4372	195	73

Weights and Cubes are approximate



94 Series Shown

### ONE COMPARTMENT WITH ONE DRAINBOARD

#### Spec-Line 94 Series

#### Standard 93 Series

#### Super Saver 9 Series

14 Ga. 304 S/S 14" Water Level	16 Ga. 304 S/S 12" Water Level	18 Ga. 304 S/S 12" Water Level
-----------------------------------	-----------------------------------	-----------------------------------

Bowl Size	O.A. Length	DRBD. Size	Model #	Price	Approx. Wt. (lbs.)	Model #	Price	Approx. Wt. (lbs.)	Model #	Price	Approx. Wt. (lbs.)	Cu. Ft.
<b>16" x 20"</b>	40"	18"	94-1-24-18RorL	\$3624	93	93-1-24-18RorL	\$3128	75	9-1-24-18RorL	\$2934	65	20
	46"	24"	94-1-24-24RorL	3686	98	93-1-24-24RorL	3166	80	9-1-24-24RorL	2963	73	24
	58"	36"	94-1-24-36RorL	4017	114	93-1-24-36RorL	3499	90	9-1-24-36RorL	3228	78	26
<b>20" x 20"</b>	44"	18"	94-21-20-18RorL	3979	98	93-21-20-18RorL	3466	80	9-21-20-18RorL	3147	71	20
	50"	24"	94-21-20-24RorL	4041	104	93-21-20-24RorL	3493	86	9-21-20-24RorL	3180	77	23
	62"	36"	94-21-20-36RorL	4527	127	93-21-20-36RorL	3593	107	9-21-20-36RorL	3254	91	31
<b>18" x 24"</b>	42"	18"	94-61-18-18RorL	4119	100	93-61-18-18RorL	3625	84	9-61-18-18RorL	3318	75	24
	48"	24"	94-61-18-24RorL	4185	106	93-61-18-24RorL	3651	92	9-61-18-24RorL	3346	84	27
	60"	36"	94-61-18-36RorL	4657	130	93-61-18-36RorL	3747	109	9-61-18-36RorL	3417	95	38
<b>24" x 24"</b>	54"	24"	94-41-24-24RorL	4722	126	93-41-24-24RorL	4201	105	9-41-24-24RorL	3834	92	28
	66"	36"	94-41-24-36RorL	5452	149	93-41-24-36RorL	4295	126	9-41-24-36RorL	3934	110	42
<b>20" x 28"</b>	44"	18"	94-81-20-18RorL	4621	139	93-81-20-18RorL	4234	116	9-81-20-18RorL	3885	107	36
	50"	24"	94-81-20-24RorL	4700	146	93-81-20-24RorL	4316	122	9-81-20-24RorL	3959	113	46
	62"	36"	94-81-20-36RorL	5933	170	93-81-20-36RorL	4397	142	9-81-20-36RorL	4056	133	54

Weights and Cubes are approximate

See pages 29 and 30 for faucets, accessories, and modifications.

# REGALINE

## Deep Drawn Sinks



### TWO COMPARTMENTS WITH TWO DRAINBOARDS

#### Spec-Line 94 Series

#### Standard 93 Series

#### Super Saver 9 Series

14 Ga. 304 S/S  
14" Water Level

16 Ga. 304 S/S  
12" Water Level

18 Ga. 304 S/S  
12" Water Level

Bowl Size	O.A. Length	DRBD. Size	Model #	Price	Approx. Wt. (lbs.)	Model #	Price	Approx. Wt. (lbs.)	Model #	Price	Approx. Wt. (lbs.)	Cu. Ft.
16" x 20"	72"	18"	94-2-36-18RL	\$5067	141	93-2-36-18RL	\$4299	118	9-2-36-18RL	\$3921	100	40
	85"	24"	94-2-36-24RL	5186	156	93-2-36-24RL	4378	130	9-2-36-24RL	3985	110	46
	109"	36"	94-2-36-36RL	5734	212	93-2-36-36RL	4948	169	9-2-36-36RL	4454	144	58
20" x 20"	81"	18"	94-22-40-18RL	5713	176	93-22-40-18RL	4861	147	9-22-40-18RL	4344	125	44
	93"	24"	94-22-40-24RL	5809	220	93-22-40-24RL	4916	184	9-22-40-24RL	4380	162	50
	117"	36"	94-22-40-36RL	6352	273	93-22-40-36RL	5216	237	9-22-40-36RL	4623	215	72
18" x 24"	77"	18"	94-62-36-18RL	5809	247	93-62-36-18RL	4982	206	9-62-36-18RL	4483	181	50
	89"	24"	94-62-36-24RL	5904	277	93-62-36-24RL	5033	241	9-62-36-24RL	4516	226	58
	113"	36"	94-62-36-36RL	6427	341	93-62-36-36RL	5319	297	9-62-36-36RL	4748	271	96
24" x 24"	101"	24"	94-42-48-24RL	7032	339	93-42-48-24RL	6223	295	9-42-48-24RL	5638	259	65
	125"	36"	94-42-48-36RL	7551	391	93-42-48-36RL	6444	339	9-42-48-36RL	6319	314	96
20" x 28"	81"	18"	94-82-40-18RL	6684	251	93-82-40-18RL	6494	219	9-82-40-18RL	6163	194	64
	93"	24"	94-82-40-24RL	6983	294	93-82-40-24RL	6634	253	9-82-40-24RL	6300	228	73
	117"	36"	94-82-40-36RL	7455	333	93-82-40-36RL	6768	287	9-82-40-36RL	6415	261	96

Weights and Cubes are approximate



### TWO COMPARTMENTS WITH ONE DRAINBOARD

#### Spec-Line 94 Series

#### Standard 93 Series

#### Super Saver 9 Series

14 Ga. 304 S/S  
14" Water Level

16 Ga. 304 S/S  
12" Water Level

18 Ga. 304 S/S  
12" Water Level

Bowl Size	O.A. Length	DRBD. Size	Model #	Price	Approx. Wt. (lbs.)	Model #	Price	Approx. Wt. (lbs.)	Model #	Price	Approx. Wt. (lbs.)	Cu. Ft.
16" x 20"	58"	18"	94-2-36-18RorL	\$4897	108	93-2-36-18RorL	\$4140	88	9-2-36-18RorL	\$3797	72	26
	64"	24"	94-2-36-24RorL	4982	115	93-2-36-24RorL	4203	96	9-2-36-24RorL	3838	80	34
	76"	36"	94-2-36-36RorL	5238	158	93-2-36-36RorL	4278	132	9-2-36-36RorL	3895	115	42
20" x 20"	66"	18"	94-22-40-18RorL	5538	118	93-22-40-18RorL	4714	96	9-22-40-18RorL	4227	83	30
	72"	24"	94-22-40-24RorL	5604	136	93-22-40-24RorL	4738	114	9-22-40-24RorL	4245	95	39
	84"	36"	94-22-40-36RorL	5908	163	93-22-40-36RorL	4816	140	9-22-40-36RorL	4303	123	46
18" x 24"	62"	18"	94-62-36-18RorL	5638	147	93-62-36-18RorL	4834	128	9-62-36-18RorL	4370	115	40
	68"	24"	94-62-36-24RorL	5703	160	93-62-36-24RorL	4861	139	9-62-36-24RorL	4386	126	44
	80"	36"	94-62-36-36RorL	5998	200	93-62-36-36RorL	4935	174	9-62-36-36RorL	4440	158	53
24" x 24"	80"	24"	94-42-48-24RorL	6743	229	93-42-48-24RorL	5968	194	9-42-48-24RorL	5447	172	53
	92"	36"	94-42-48-36RorL	7152	261	93-42-48-36RorL	6423	235	9-42-48-36RorL	6123	194	60
20" x 28"	66"	18"	94-82-40-18RorL	6636	213	93-82-40-18RorL	6355	183	9-82-40-18RorL	5970	167	60
	72"	24"	94-82-40-24RorL	6714	227	93-82-40-24RorL	6433	195	9-82-40-24RorL	6047	176	64
	84"	36"	94-82-40-36RorL	7084	266	93-82-40-36RorL	6643	227	9-82-40-36RorL	6097	207	76

Weights and Cubes are approximate

See pages 29 and 30 for faucets, accessories, and modifications.





# REGALINE

## Deep Drawn Sinks



### THREE COMPARTMENTS WITH TWO DRAINBOARDS

Spec-Line 94 Series

Standard 93 Series

Super Saver 9 Series

14 Ga. 304 S/S  
14" Water Level

16 Ga. 304 S/S  
12" Water Level

18 Ga. 304 S/S  
12" Water Level

Bowl Size	O.A. Length	DRBD. Size	Model #	Price	Approx. Wt. (lbs.)	Model #	Price	Approx. Wt. (lbs.)	Model #	Price	Approx. Wt. (lbs.)	Cu. Ft.
<b>16" x 20"</b>	91"	18"	94-3-54-18RL	\$6007	230	93-3-54-18RL	\$5146	189	9-3-54-18RL	\$3974	182	49
	103"	24"	94-3-54-24RL	6133	248	93-3-54-24RL	5224	197	9-3-54-24RL	4041	190	55
	127"	36"	94-3-54-36RL	6725	275	93-3-54-36RL	5544	239	9-3-54-36RL	5224	208	96
<b>20" x 20"</b>	103"	18"	94-23-60-18RL	7076	248	93-23-60-18RL	6102	203	9-23-60-18RL	5473	198	59
	115"	24"	94-23-60-24RL	7284	276	93-23-60-24RL	6260	220	9-23-60-24RL	5607	195	65
	139"	36"	94-23-60-36RL	7856	408	93-23-60-36RL	6487	387	9-23-60-36RL	5787	364	89
<b>18" x 24"</b>	97"	18"	94-63-54-18RL	7131	323	93-63-54-18RL	6184	289	9-63-54-18RL	5576	226	62
	109"	24"	94-63-54-24RL	7335	334	93-63-54-24RL	6333	304	9-63-54-24RL	5709	233	85
	133"	36"	94-63-54-36RL	7886	418	93-63-54-36RL	6559	367	9-63-54-36RL	5876	325	96
<b>24" x 24"</b>	*127"	24"	94-43-72-24RL	8691	390	93-43-72-24RL	7832	331	9-43-72-24RL	7103	318	98
	*151"	36"	94-43-72-36RL	9324	448	93-43-72-36RL	8005	393	9-43-72-36RL	7570	345	110
<b>20" x 28"</b>	103"	18"	94-83-60-18RL	8794	358	93-83-60-18RL	7867	315	9-83-60-18RL	7494	277	83
	115"	24"	94-83-60-24RL	8922	394	93-83-60-24RL	8001	346	9-83-60-24RL	7622	305	95
	139"	36"	94-83-60-36RL	9590	451	93-83-60-36RL	8192	398	9-83-60-36RL	7753	350	109

\* Requires Two Faucets

Weights and Cubes are approximate



### THREE COMPARTMENTS WITH ONE DRAINBOARD

Spec-Line 94 Series

Standard 93 Series

Super Saver 9 Series

14 Ga. 304 S/S  
14" Water Level

16 Ga. 304 S/S  
12" Water Level

18 Ga. 304 S/S  
12" Water Level

Bowl Size	O.A. Length	DRBD. Size	Model #	Price	Approx. Wt. (lbs.)	Model #	Price	Approx. Wt. (lbs.)	Model #	Price	Approx. Wt. (lbs.)	Cu. Ft.
<b>16" x 20"</b>	77"	18"	94-3-54-18RorL	\$5864	214	93-3-54-18RorL	\$5008	173	9-3-54-18RorL	\$3841	167	42
	83"	24"	94-3-54-24RorL	5926	222	93-3-54-24RorL	5046	188	9-3-54-24RorL	3877	177	45
	95"	36"	94-3-54-36RorL	6262	243	93-3-54-36RorL	5383	220	9-3-54-36RorL	4855	190	51
<b>20" x 20"</b>	89"	18"	94-23-60-18RorL	6917	234	93-23-60-18RorL	5939	207	9-23-60-18RorL	5341	184	52
	95"	24"	94-23-60-24RorL	6963	245	93-23-60-24RorL	5965	205	9-23-60-24RorL	5358	193	55
	107"	36"	94-23-60-36RorL	7357	252	93-23-60-36RorL	6160	216	9-23-60-36RorL	5421	208	60
<b>18" x 24"</b>	83"	18"	94-63-54-18RorL	6979	296	93-63-54-18RorL	6023	271	9-63-54-18RorL	5447	255	54
	89"	24"	94-63-54-24RorL	7025	308	93-63-54-24RorL	6047	281	9-63-54-24RorL	5465	269	58
	101"	36"	94-63-54-36RorL	7404	318	93-63-54-36RorL	6241	300	9-63-54-36RorL	5522	287	65
<b>24" x 24"</b>	*107"	24"	94-43-72-24RorL	8470	342	93-43-72-24RorL	7604	312	9-43-72-24RorL	6948	298	68
	*119"	36"	94-43-72-36RorL	9154	365	93-43-72-36RorL	7668	339	9-43-72-36RorL	7373	320	96
<b>20" x 28"</b>	89"	18"	94-83-60-18RorL	8546	281	93-83-60-18RorL	7671	232	9-83-60-18RorL	7333	225	79
	95"	24"	94-83-60-24RorL	8621	296	93-83-60-24RorL	7748	273	9-83-60-24RorL	7406	268	86
	107"	36"	94-83-60-36RorL	8921	308	93-83-60-36RorL	7820	287	9-83-60-36RorL	7451	277	89

\* Requires Two Faucets

Weights and Cubes are approximate

See pages 29 and 30 for faucets, accessories, and modifications.

# REGALINE

## Deep Drawn Sinks



### FOUR COMPARTMENTS WITH TWO DRAINBOARDS

#### Spec-Line 94 Series

#### Standard 93 Series

#### Super Saver 9 Series

14 Ga. 304 S/S  
14" Water Level

16 Ga. 304 S/S  
12" Water Level

18 Ga. 304 S/S  
12" Water Level

Bowl Size	O.A. Length	DRBD. Size	Model #	Price	Approx. Wt. (lbs.)	Model #	Price	Approx. Wt. (lbs.)	Model #	Price	Approx. Wt. (lbs.)	Cu. Ft.
16" x 20"	110"	18"	94-4-72-18RL	\$7521	210	93-4-72-18RL	\$6482	183	9-4-72-18RL	\$6012	175	58
	122"	24"	94-4-72-24RL	7661	275	93-4-72-24RL	6580	252	9-4-72-24RL	6093	241	64
	146"	36"	94-4-72-36RL	8221	313	93-4-72-36RL	6780	287	9-4-72-36RL	6452	274	86
20" x 20"	126"	18"	94-24-80-18RL	8774	293	93-24-80-18RL	7551	268	9-24-80-18RL	6780	259	87
	138"	24"	94-24-80-24RL	8863	312	93-24-80-24RL	7648	286	9-24-80-24RL	6840	275	95
	162"	36"	94-24-80-36RL	9499	351	93-24-80-36RL	7858	322	9-24-80-36RL	7195	308	111
18" x 24"	118"	18"	94-64-72-18RL	8778	358	93-64-72-18RL	7592	346	9-64-72-18RL	6843	336	82
	130"	24"	94-64-72-24RL	8864	372	93-64-72-24RL	7685	355	9-64-72-24RL	6905	344	90
	154"	36"	94-64-72-36RL	9480	409	93-64-72-36RL	7889	392	9-64-72-36RL	7249	378	106
24" x 24"	154"	24"	94-44-96-24RL	10471	395	93-44-96-24RL	9863	361	9-44-96-24RL	8734	348	106
	178"	36"	94-44-96-36RL	11226	431	93-44-96-36RL	10089	398	9-44-96-36RL	9496	382	122
20" x 28"	126"	18"	94-84-80-18RL	10645	382	93-84-80-18RL	10076	361	9-84-80-18RL	9512	350	97
	138"	24"	94-84-80-24RL	10780	402	93-84-80-24RL	10211	374	9-84-80-24RL	9647	361	106
	162"	36"	94-84-80-36RL	11581	442	93-84-80-36RL	10410	411	9-84-80-36RL	9760	395	124

ALL UNITS REQUIRE TWO FAUCETS

Weights and Cubes are approximate



### FOUR COMPARTMENTS WITH ONE DRAINBOARD

#### Spec-Line 94 Series

#### Standard 93 Series

#### Super Saver 9 Series

14 Ga. 304 S/S  
14" Water Level

16 Ga. 304 S/S  
12" Water Level

18 Ga. 304 S/S  
12" Water Level

Bowl Size	O.A. Length	DRBD. Size	Model #	Price	Approx. Wt. (lbs.)	Model #	Price	Approx. Wt. (lbs.)	Model #	Price	Approx. Wt. (lbs.)	Cu. Ft.
16" x 20"	95"	18"	94-4-72-18RorL	\$7251	202	93-4-72-18RorL	\$6225	165	9-4-72-18RorL	\$5788	158	52
	101"	24"	94-4-72-24RorL	7317	216	93-4-72-24RorL	6267	186	9-4-72-24RorL	5814	175	54
	113"	36"	94-4-72-36RorL	7835	260	93-4-72-36RorL	6463	238	9-4-72-36RorL	6182	227	60
20" x 20"	111"	18"	94-24-80-18RorL	8563	299	93-24-80-18RorL	7400	241	9-24-80-18RorL	6155	229	61
	117"	24"	94-24-80-24RorL	8610	320	93-24-80-24RorL	7426	250	9-24-80-24RorL	6684	239	82
	129"	36"	94-24-80-36RorL	9120	341	93-24-80-36RorL	7526	267	9-24-80-36RorL	6767	250	90
18" x 24"	103"	18"	94-64-72-18RorL	8574	339	93-64-72-18RorL	7447	329	9-64-72-18RorL	6351	318	72
	109"	24"	94-64-72-24RorL	8621	351	93-64-72-24RorL	7473	338	9-64-72-24RorL	6751	329	76
	121"	36"	94-64-72-36RorL	9115	369	93-64-72-36RorL	7572	353	9-64-72-36RorL	6827	341	84
24" x 24"	133"	24"	94-44-96-24RorL	10185	354	93-44-96-24RorL	9649	336	9-44-96-24RorL	8547	327	92
	145"	36"	94-44-96-36RorL	10531	376	93-44-96-36RorL	9769	355	9-44-96-36RorL	9209	344	100
20" x 28"	111"	18"	94-84-80-18RorL	10397	348	93-84-80-18RorL	9878	329	9-84-80-18RorL	9324	317	87
	117"	24"	94-84-80-24RorL	10473	364	93-84-80-24RorL	9953	337	9-84-80-24RorL	9403	329	91
	129"	36"	94-84-80-36RorL	11142	382	93-84-80-36RorL	10032	355	9-84-80-36RorL	9443	347	100

ALL UNITS REQUIRE TWO FAUCETS

Weights and Cubes are approximate

See pages 29 and 30 for faucets, accessories, and modifications.



# SPECIALTY SINKS

## Specialty Sinks

### Corner Sinks

16 Gauge, 304 Stainless Steel

- Welded Cross-Bracing
- Stainless Steel Legs
- Stainless Steel Adjustable Bullet Feet



94-K3-11D Shown



MINI CORNER

OPTIONAL:

5/8" Thick Poly-Vance Cutting Boards Available  
(See Grid For Proper Model)

### Six Deep Drawn Combinations To Choose From!

Model #	Bowl Sizes	Wall Dim.	Drbd. Dim.	Price	Approx. Wt.	Approx. Cubes	Optional Poly-Vance Cutting Boards
94-K6-18D	1) 20" x 20" x 12" 2) 16" x 20" x 12"	61" x 61"	18"	\$6901	231 lbs.	71	K-2E \$268
94-K2-24D	3) 20" x 20" x 12"	71" x 71"	24"	7083	265 lbs.	99	K-2E 268
94-K4-24D	3) 24" x 24" x 12"	79" x 79"	24"	7553	338 lbs.	114	K-2F 268
94-K8-30D	1) 20" x 20" x 12" 2) 20" x 28" x 12"	86" x 86"	30"	8041	350 lbs.	131	K-2E 268
94-K3-11D	1) 14" x 14" x 12" 2) 14" x 16" x 12"	54" x 54"	17"	4729	215 lbs.	60	K-2H 268
94-K5-11D	1) 14" x 14" x 10" 2) 10" x 14" x 10"	42" x 42"	11"	5123	180 lbs.	37	K-2H 268

## FABRICATED SPECIALTY SINKS

### Convenience Store Sinks

Our Solution....to Your Limited Space Problem  
In Six Feet or less... you can WASH, RINSE & SANITIZE

- 18 Gauge Stainless Steel
- Stainless Steel Legs
- Welded Cross Bracing
- Stainless Steel Adjustable Bullet Feet

All Sinks Feature TWO Drainboards



Model #	Bowl Size	# of Comp.	Drbd. Size	O.A. Length	Price	Approx. Wt.	Approx. Cu.
K7-CS-21	10" x 14" x 10"	3	12"	58"	\$2527	85 lbs.	27
K7-CS-22	10" x 14" x 10"	3	18"	70"	2597	120 lbs.	39
K7-CS-29	14" x 16" x 12"	3	12"	70"	2768	138 lbs.	39
K7-CS-32	12" x 20" x 12"	3	12"	64"	3211	130 lbs.	35



### Super Size Sinks 16 Gauge, 304 Stainless Steel

Model #	Bowl Size	# of Comp.	Drbd. Size	Overall Size L x W	Price	Approx. Wt.	Approx. Cu.
K7-3-1432-18RL*	14" x 32" x 12"	3	18"	78" x 36"	\$6728	290 lbs.	50
K7-3-2030-24RL	20" x 30" x 14"	3	24"	108" x 36"	9632	345 lbs.	78
K7-3-2430-24RL	24" x 30" x 14"	3	24"	120" x 36"	10014	380 lbs.	86
K7-3-3024-24RL	30" x 24" x 14"	3	24"	138" x 30"	10366	395 lbs.	84
K7-3-3030-24RL	30" x 30" x 14"	3	24"	138" x 36"	10857	420 lbs.	98

\*12" Deep Bowls For 14 Gauge Units Add -14 At End Of Model Number & Add \$560 List.

- Fabricated Design
- 16 ga. 304 Series
- 14" Deep Bowls
- Tile Edge Splash
- Full Skirt Design
- Stainless Steel Legs
- Stainless Steel Adjustable Bullet Feet
- Space Saving - Reduced Overall Lengths

### Meat & Platter Sink

16 Gauge, 304 Stainless Steel

- Two 18" Drainboards
- 91" x 35 1/2"

Bowl Sizes:

- 1 - 24" x 30" Bowl
- 2 - 15" x 32" Bowls

• 351 lbs. 59 Cu. Ft.



18-K5-56 \$10170

### Heavy Duty Extra Long Faucet

Required Faucet For Meat & Platter Sink

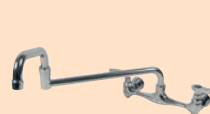

- Splash Mount
- 18" Swing Spout
- 8" O.C.
- T&S Equivalent: 5f-8WLX18

K-211 \$581

Units Can Be Customized With Modifications & Accessories!  
See Pages 29 & 30. Other Sizes Available. Call For Pricing.

# FABRICATED

## Fabricated Sinks



Fabricated Bowls are Welded Together at the Seams & Polished

### Features and Benefits

- 3/4" Radius Corners
- Economical Savings
- Satin Finish



## SPEC-LINE 14 GAUGE FABRICATED SINKS

- 14 Ga. 304 Stainless Steel
- 14" Deep Bowls
- Tile Edge Splash
- Continuous Apron Design
- All Welded Super-Sturdy Cross-Bracing
- Stainless Steel Legs & Adjustable Stainless Steel Bullet Feet

### FS Series: 1 Compartment Sinks

Bowl Size	Model #	O.A. Length	O.A. Width	Price	Wt.	Cu.
16" x 20"	FS-1-1620	21"	26"	\$2157	60	12
	FS-1-1620-18RorL	36.5"	26"	2318	80	20
	FS-1-1620-18RL	52"	26"	2519	100	27
18" x 18"	FS-1-1818	23"	24"	2200	60	11
	FS-1-1818-18RorL	38.5"	24"	2474	75	17
18" x 24"	FS-1-1824	23"	30"	2391	78	16
	FS-1-1824-18RorL	38.5"	30"	2737	92	25
	FS-1-1824-24RorL	44.5"	30"	2872	105	28
	FS-1-1824-18RL	54"	30"	2940	175	34
	FS-1-1824-24RL	66"	30"	3069	198	40
24" x 24"	FS-1-2424	29"	30"	2750	90	19
	FS-1-2424-18RorL	44.5"	30"	3092	110	28
	FS-1-2424-24RorL	50.5"	30"	3128	119	34
	FS-1-2424-18RL	60"	30"	3191	185	37
	FS-1-2424-24RL	72"	30"	3850	209	44
30" x 24"	FS-1-3024	35"	30"	3162	115	23
	FS-1-3024-24RorL	56.5"	30"	3709	132	35
	FS-1-3024-24RL	78"	30"	3987	150	47
36" x 24"	FS-1-3624	41"	30"	3574	125	26
	FS-1-3624-24RorL	62.5"	30"	4124	143	39
	FS-1-3624-24RL	84"	30"	5362	165	51

### FS Series: 2 Compartment Sinks

Bowl Size	Model #	O.A. Length	O.A. Width	Price	Wt.	Cu.
16" x 20"	FS-2-1620	37"	26"	\$3101	100	20
	FS-2-1620-18RorL	52.5"	26"	3368	120	27
	FS-2-1620-18RL	68"	26"	3452	143	34
18" x 18"	FS-2-1818	41"	24"	3162	98	18
	FS-2-1818-18RorL	56.5"	24"	3402	110	26
	FS-2-1818-18RL	72"	24"	3574	125	30
18" x 24"	FS-2-1824	41"	30"	3327	149	26
	FS-2-1824-18RorL	56.5"	30"	3668	169	35
	FS-2-1824-24RorL	62.5"	30"	4081	190	39
	FS-2-1824-18RL	72"	30"	4193	220	44
	FS-2-1824-24RL	84"	30"	4854	240	51
24" x 24"	FS-2-2424	53"	30"	3664	179	33
	FS-2-2424-18RorL	68.5"	30"	4487	200	42
	FS-2-2424-24RorL	74.5"	30"	4597	220	46
	FS-2-2424-18RL	84"	30"	4838	245	51
	FS-2-2424-24RL	96"	30"	5184	270	58
30" x 24"	FS-2-3024	65"	30"	4537	265	40
	FS-2-3024-24RorL	86.5"	30"	5362	300	52
	FS-2-3024-24RL	108"	30"	5636	320	64

### FS Series: 3 Compartment Sinks

Bowl Size	Model #	O.A. Length	O.A. Width	Price	Wt.	Cu.
16" x 20"	FS-3-1620	53"	26"	\$4355	140	27
	FS-3-1620-18RorL	68.5"	26"	4847	160	35
	FS-3-1620-18RL	84"	26"	5319	155	36
	FS-3-1620-24RL	96"	26"	5722	235	47
	FS-3-1620-36RL	120"	26"	5921	280	59
18" x 18"	FS-3-1818	59"	24"	4537	130	25
	FS-3-1818-18RorL	75"	24"	4950	150	31
	FS-3-1818-18RL	90"	24"	5499	170	52
18" x 24"	FS-3-1824	59"	30"	4702	158	36
	FS-3-1824-18RorL	74.5"	30"	5281	174	46
	FS-3-1824-24RorL	80.5"	30"	5444	187	49
	FS-3-1824-18RL	90"	30"	6037	310	54
	FS-3-1824-24RL	102"	30"	6460	375	61
24" x 24"	FS-3-2424†	77"	30"	5292	329	47
	FS-3-2424-18RorL†	92.5"	30"	5904	353	56
	FS-3-2424-24RorL†	98.5"	30"	6048	369	59
	FS-3-2424-18RL†	108"	30"	6668	382	64
	FS-3-2424-24RL†	120"	30"	6805	405	71

† Requires Two Sets of Faucets



**SUPER STURDY**  
CROSS BRACING

Optional Front Cross-Bracing for FS Series Sinks  
**FC-CB-1 \$32 per foot**

Stainless Steel Leg with Bullet foot  
**K-475 \$65 per leg**

Stainless Steel Sink Covers  
See Page 29

Removable 12" Side Splashes  
For FS & FC Series Sinks  
Accommodates Left & right Sides

**K-700F-24 \$457 ea.**  
For sinks with 24" front-to-back bowls

**K-700F-18 \$435 ea.**  
For sinks with 18" front-to-back bowls

**K-700 \$435 ea.**  
(For all other sink sizes)

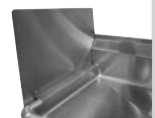

**Additional Sizes Available.  
See Modifications & Accessories on Pages 29 & 30**





**SUPER STURDY**  
CROSS BRACING



# FABRICATED Sinks

## 16 GAUGE FABRICATED SINKS

- 16 Ga. 304 Stainless Steel
- 14" Deep Bowls
- All Welded Super-Sturdy Cross-Bracing
- Tile Edge Splash
- Stainless Steel Legs & Adjustable Stainless Steel Bullet Feet

### FC Series: 1 Compartment Sinks

Bowl Size	Model #	O.A. Length	O.A. Width	Price	Wt.	Cu.
<b>16" x 20"</b>	FC-1-1620	21"	26"	\$1127	50	12
	FC-1-1620-18RorL	36.5"	26"	1804	65	20
	FC-1-1620-18RL	52"	26"	1864	80	27
<b>18" x 18"</b>	FC-1-1818	23"	24"	1101	60	11
	FC-1-1818-18RorL	38.5"	24"	1752	65	17
	FC-1-1818-18RL	54"	24"	1784	70	16
	FC-1-1818-24RorL	45"	24"	2006	90	25
	FC-1-1818-24RL	66"	24"	2072	100	28
<b>18" x 24"</b>	FC-1-1824	23"	30"	1280	67	34
	FC-1-1824-18RorL	38.5"	30"	1942	105	40
	FC-1-1824-24RorL	45"	30"	2044	115	19
	FC-1-1824-18RL	54"	30"	2007	120	28
	FC-1-1824-24RL	66"	30"	2080	130	34
<b>24" x 24"</b>	FC-1-2424	29"	30"	1361	90	19
	FC-1-2424-18RorL	44.5"	30"	2065	118	44
	FC-1-2424-24RorL	50.5"	30"	2237	123	32
	FC-1-2424-18RL	60"	30"	2190	135	35
	FC-1-2424-24RL	72"	30"	2310	145	45

### FC Series: 2 Compartment Sinks

Bowl Size	Model #	O.A. Length	O.A. Width	Price	Wt.	Cu.
<b>15" x 15"</b>	FC-2-1515	35"	21"	\$1910	78	11
<b>16" x 20"</b>	FC-2-1620	37"	26"	2198	85	20
	FC-2-1620-18RorL	52.5"	26"	2574	100	27
	FC-2-1620-18RL	68"	26"	2648	118	34
<b>18" x 18"</b>	FC-2-1818	41"	24"	2069	83	22
	FC-2-1818-18RorL	56.5"	24"	2394	90	30
	FC-2-1818-18RL	72"	24"	2535	105	37
	FC-2-1818-24RL	84"	24"	2724	118	43
<b>18" x 24"</b>	FC-2-1824	41"	30"	2223	115	27
	FC-2-1824-18RorL	56.5"	30"	2525	130	37
	FC-2-1824-24RorL	62.5"	30"	2761	140	40
	FC-2-1824-18RL	72"	30"	2839	145	45
<b>24" x 24"</b>	FC-2-2424	53"	30"	2424	138	34
	FC-2-2424-18RorL	68.5"	30"	2970	155	44
	FC-2-2424-24RorL	74.5"	30"	3082	195	47
	FC-2-2424-18RL	84"	30"	3022	210	53
<b>24" x 24"</b>	FC-2-2424-24RL	96"	30"	3160	225	60

### FC Series: 3 Compartment Sinks

Bowl Size	Model #	O.A. Length	O.A. Width	Price	Wt.	Cu.
<b>15" x 15"</b>	FC-3-1515	50"	21"	\$2183	110	25
	FC-3-1515-15RorL	62.5"	21"	2341	120	31
	FC-3-1515-15RL	75"	21"	2406	130	52
<b>16" x 20"</b>	FC-3-1620	53"	26"	2656	120	27
	FC-3-1620-18RorL	68.5"	26"	2838	135	35
	FC-3-1620-18RL	84"	26"	2997	150	36
	FC-3-1620-24RL	96"	26"	3208	205	47
	FC-3-1620-36RL	120"	26"	3667	240	59
<b>18" x 18"</b>	FC-3-1818	59"	24"	2560	120	46
	FC-3-1818-18RorL	74.5"	24"	2721	128	49
	FC-3-1818-24RorL	80.5"	24"	2809	136	54
	FC-3-1818-18RL	90"	24"	2754	143	46
	FC-3-1818-24RL	102"	24"	2884	150	52
<b>18" x 24"</b>	FC-3-1824	59"	30"	2611	135	56
	FC-3-1824-18RorL	74.5"	30"	3080	142	59
	FC-3-1824-24RorL	80.5"	30"	3211	150	64
	FC-3-1824-18RL	90"	30"	3449	265	56
	FC-3-1824-24RL	102"	30"	3619	300	63
<b>24" x 24"</b>	†FC-3-2424	79"	30"	2890	175	48
	†FC-3-2424-18RorL	92.5"	30"	3767	310	58
	†FC-3-2424-24RorL	98.5"	30"	3928	330	61
	†FC-3-2424-24RL	120"	30"	4009	350	74
	†FC-3-2424-18RL	108"	30"	3890	330	67
<b>20" x 28"</b>	FC-3-2028-24RL	108"	34"	4450	315	75
<b>20" x 30"</b>	FC-3-2030-20RL	100"	36"	4042	315	73
	FC-3-2030-30RL	120"	36"	5002	370	81
<b>24" x 30"</b>	†FC-3-2430	77"	36"	3439	200	38
	†FC-3-2430-24RorL	99"	36"	4004	175	59
	†FC-3-2430-24RL	120"	36"	5934	400	81
	†FC-3-2430-30RorL	105"	36"	5252	425	62
	†FC-3-2430-30RL	132"	36"	6113	445	86
	†FC-3-2430-36RorL	111"	36"	5449	450	66
<b>30" x 24"</b>	†FC-3-2430-36RL	144"	36"	6196	490	93
	†FC-3-3024	95"	30"	4007	200	38
	†FC-3-3024-24RorL	117"	30"	5233	375	59
	†FC-3-3024-24RL	138"	30"	6004	400	81
	†FC-3-3024-30RorL	123"	30"	5485	425	62
	†FC-3-3024-30RL	150"	30"	6212	445	86
<b>30" x 30"</b>	†FC-3-3024-36RorL	129"	30"	5597	450	66
	†FC-3-3024-36RL	162"	30"	6431	450	66
	†FC-3-3030	95"	36"	5486	240	43
	†FC-3-3030-24RL	138"	36"	9284	470	70
	†FC-3-3030-30RL	150"	36"	9706	515	78
	†FC-3-3030-36RL	162"	36"	9812	560	86

## Fabricated Corner Sink

16 Gauge, 304 Stainless Steel

**FC-K6-18D \$4971**



- Welded Cross-Bracing
- S/S Legs & Bullet Feet
- Requires 2 Faucets (Not Included)
- 3 - 18" x 18" x 14" Bowls
- 2 - 18" x 18" Drainboards
- Wall Dimension: 57" x 57"
- 248 lbs. 66 Cu. Ft.

### FC Series: 4 Compartment Sinks

Bowl Size	Model #	O.A. Length	O.A. Width	Price	Wt.	Cu.
<b>18" x 18"</b>	FC-4-1818-18RL†	108"	24"	\$4413	270	51
<b>18" x 24"</b>	FC-4-1824-18RL†	108"	30"	4915	325	62
<b>24" x 24"</b>	FC-4-2424-24RL†	144"	30"	5774	355	80

† Requires Two Sets of Faucets

Additional Sizes Available. See Modifications & Accessories on Pages 29 & 30

# BUDGET SINKS

## Budget Line Scullery Sinks

 = Ship Via UPS



18" - 21" Wide Sink Bowls Are 14" Deep  
24" Wide Sink Bowls Are 13" Deep

Includes 3 1/2" Basket Drain & 8" O.C. Faucet Holes

### 1 COMPARTMENT SINKS

Size	L	Wt.	Cu. Ft.	"400" Series (430 S/S)		"600" Series (300 S/S)	
				Model #	Price	Model #	Price
18" x 18"	18"	44 lbs.	8	4-81-18	\$981	6-81-18	\$1126
21" x 18"	18"	47 lbs.	9	4-1-18	998	6-1-18	1162
21" x 24"	24"	53 lbs.	12	4-1-24	1016	6-1-24	1272
21" x 36"	36"	66 lbs.	16	4-1-36	1162	6-1-36	1308
24" x 24"	24"	54 lbs.	12	4-41-24	1233	6-41-24	1363
24" x 36"	36"	69 lbs.	17	4-41-36	1320	6-41-36	1455

### 3 COMPARTMENT SINKS

Size	L	Wt.	Cu. Ft.	"400" Series (430 S/S)		"600" Series (300 S/S)	
				Model #	Price	Model #	Price
21" x 36"	36"	78 lbs.	16	4-3-36	\$1545	6-3-36	\$1727
21" x 48"	48"	91 lbs.	21	4-3-48	1674	6-3-48	1982
21" x 54"	54"	98 lbs.	24	4-3-54	1743	6-3-54	2034
** 21" x 72"	72"	115 lbs.	31	4-3-72	2255	6-3-72	2545
24" x 60"	60"	108 lbs.	27	4-43-60	2181	6-43-60	2454
** 24" x 72"	72"	118 lbs.	32	4-43-72	2329	6-43-72	2656

### 2 COMPARTMENT SINKS

Size	L	Wt.	Cu. Ft.	"400" Series (430 S/S)		"600" Series (300 S/S)	
				Model #	Price	Model #	Price
21" x 36"	36"	73 lbs.	16	4-2-36	\$1436	6-2-36	\$1617
21" x 48"	48"	86 lbs.	21	4-2-48	1564	6-2-48	1779
21" x 60"	60"	98 lbs.	26	4-2-60	1982	6-2-60	2072
24" x 48"	48"	88 lbs.	22	4-42-48	1727	6-42-48	1908
24" x 60"	60"	108 lbs.	27	4-42-60	2091	6-42-60	2364

### 4 COMPARTMENT SINKS

Size	L	Wt.	Cu. Ft.	"400" Series (430 S/S)		"600" Series (300 S/S)	
				Model #	Price	Model #	Price
†** 21" x 48"	48"	95 lbs.	21	4-4-48	\$1855	6-4-48	\$2144
** 21" x 60"	60"	113 lbs.	26	4-4-60	2364	6-4-60	2536
21" x 72"	72"	120 lbs.	21	4-4-72	2545	6-4-72	2729

† Quick-Drain Omitted In This Size \*\* Requires Two Faucets

For Residential Finish & Packaging, Add K-350 \$343

## BUDGET SINK ACCESSORIES

All Budget Sink Accessories Ship Via UPS

### Drainboards



- Drainboards 36" & Larger Supplied With Legs
- Sides & End Of Drainboard Turned Up with 2" Hemmed Edges Along Top

Model #	Size	Approx. Wt.	Approx. Cu. Ft.	Price
N-5-818	18" x 18"	13 lbs.	1	\$371
N-5-18	21" x 18"	15 lbs.	1	399
N-5-24	21" x 24"	18 lbs.	1	463
N-5-30	21" x 30"	22 lbs.	2	522
N-5-36	21" x 36"	25 lbs.	2	835
N-5-48	21" x 48"	28 lbs.	3	999
N-54-24	24" x 24"	20 lbs.	1	497
N-54-36	24" x 36"	25 lbs.	2	878
N-54-48	24" x 48"	30 lbs.	3	1040

### Stainless Steel Sink Covers

For One Compartment Budget Sinks

Model #	Size	Price
LSC-81	18" x 18"	\$416
LSC-24	21" x 24"	416
LSC-242	24" x 24"	416
LSC-36	24" x 36"	416



Stores Conveniently On Side Of Sink

## MOBILE & SILVER SOAK SINKS



### Mobile Sinks

34" Working Height

A Multi-Purpose Unit.

Move it where the ACTION is! A must for the large food preparation type installation.

Model #	Bowl Size	Price	Approx. Wt.
9-FMS-20	22" x 22" x 8"	\$3819	50 lbs.
9-FMS-12	22" x 22" x 12"	4184	50 lbs.

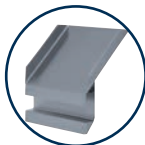

Optional Chute  
9-SS-1 \$441



Optional Bumpers  
9-SS-2 \$208

### Silver Soak Sinks

20" Working Height

UNIVERSAL BOWL SIZE.

Accommodates 19 3/4" x 19 3/4" Dishwasher Baskets

Model #	Bowl Size	Price	Approx. Wt.
9-FSS-20	22" x 22" x 8"	\$3649	42 lbs.



### Silver Soak Sinks with Detachable Chute

20" Working Height

Required for the Scullery operation that promotes clean sanitary flatware.

Model #	Bowl Size	Price	Approx. Wt.
9-FSC-20	22" x 22" x 8"	\$4002	50 lbs.

Shown with  
Optional Bumpers



# SINK MODS

## Sink Modifications & Accessories

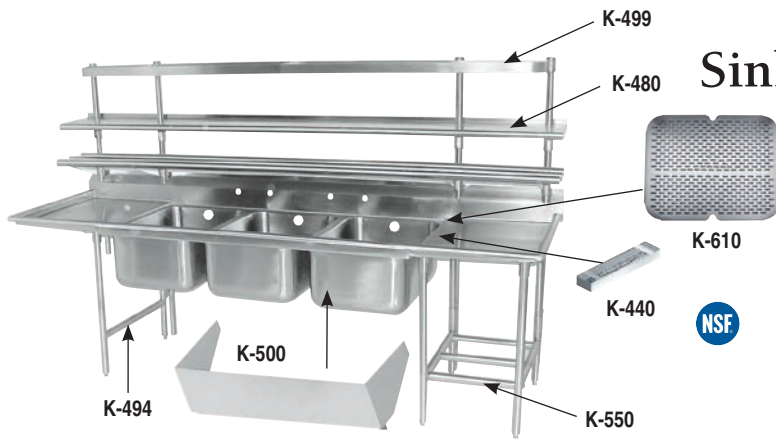

**K-37**  
Anti-Siphon  
Vacuum  
Breaker Holes



**K-72**  
Leg-To-Wall  
Brace



**K-460A**  
Disposal  
Cone w/  
Control  
Bracket &  
Faucet Holes

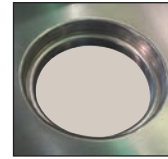

**K-461A**  
Install Collar  
w/ Control Bracket

## MODIFICATIONS

<b>K-4</b>	Support Bracket for Lever Waste Drain Handle	\$116 ea.
<b>K-23</b>	Welded Set-Up/Crated	382 per sink
<b>K-24</b>	Shell Crating	282
<b>K-37</b>	Anti-Siphon Vacuum Breaker Holes	115
<b>K-57</b>	Welded field Joint (Welded in field by others)	254 per sink
<b>K-76</b>	Paint on Sound Deadening	509
<b>K-77</b>	Splash Cutout (Pipe Chase)	180
<b>K-106</b>	Mirror Highlite Edge for Sink	395
<b>K-440</b>	Waste Trough with 2" deep removable basket	870
<b>K-447</b>	High Backsplash up to 18"	180 lin. ft.
<b>K-448</b>	High Backsplash up to 13"	145 lin. ft.
<b>K-450</b>	Extra Drainboard	367 lin. ft.
<b>K-451</b>	Drainboard Corner Turn	1278 ea.
<b>K-452</b>	Control Bracket 8" x 12"	254 ea.
<b>K-452S</b>	Splash Mounted Control Bracket 8" x 12"	289 ea.
<b>K-453</b>	Control Bracket 14" x 16"	273 ea.
<b>K-453S</b>	Splash Mounted Control Bracket 14" x 16"	319 ea.
<b>K-454</b>	Sidesplash	395 ea.
<b>K-456</b>	Scrap Block Installed	371
<b>K-460</b>	Installation of Disposal Cone with 8" x 12" Control Bracket, Faucet Holes (Cone supplied by others)	760 ea.
<b>K-460A</b>	Installation of Disposal Cone with 14" x 16" Control Bracket, Faucet Holes (Cone supplied by others)	808 ea.

<b>K-461</b>	Install Collar with 8" x 12" control bracket (Collar by others)	\$760
<b>K-461A</b>	Install Collar with 14" x 16" control bracket (Collar by others)	808
<b>K-470</b>	Modify Bowl Depth	165 ea.
<b>K-472</b>	Faucet Hole Revision	115 ea.
<b>K-473</b>	Working Height Revision	96 ea.
<b>K-476</b>	Punch for Over Flow Holes (Holes Only. N/C when ordering K-15)	52 ea.
<b>K-479</b>	Undershelf Under Drainboard	229 lin. ft.
<b>K-480</b>	Stainless Steel 12" Wide Shelf (min. of 3 ft.)	239 lin. ft.
<b>K-480A</b>	Stainless Steel 15" Wide Shelf (min. of 3 ft.)	343 lin. ft.
<b>K-490</b>	Provision for Pot Washer (For "Wells-PW-106" only)	922 ea.
<b>K-491</b>	Provision for Hatco Heater	181 ea.
<b>K-495</b>	Turn Down Backsplash (Includes 2 Brackets. See K-397 Add'l Sets)	158
<b>K-498</b>	Tubular Overshelf 12" wide (Min. 3 Ft.)	361 lin. ft.
<b>K-499</b>	Stainless Steel Pot Rack	286 lin. ft.
<b>K-500</b>	Stainless Steel Apron to Cover Sink Bowls	897 ea.
<b>K-500A</b>	17" Stainless Steel Apron to Cover Sink Bowls and Support Lever Drain Handles	1043 ea.
<b>K-508</b>	Special Sizing Charge (Larger size cut down to smaller size)	N/C ea.
<b>K-508A</b>	Special Modification Charge	242 ea.
<b>K-510</b>	Prepare Sink for Undercounter Dishwasher (24" drainboard or larger)	130 per sink
<b>K-520</b>	Poly Board/Stainless Steel Cover Holder	616 ea.
<b>K-550</b>	Stainless Steel Tubular Rack Storage	190 lin. ft.

## ACCESSORIES

<b>K-30</b>	Faucet Wall Mounting Bracket	\$323 ea.
<b>K-72</b>	Leg To Wall Brace	283
<b>K-350</b>	Residential Finish & Packaging	343 ea.
<b>K-397</b>	Wall Bracket for Sink (Includes 2 Brackets with K-495 Mod.)	77 ea.
<b>K-457</b>	Replacement Rubber Scrap Block (See K-456 for install cost)	113 ea.
<b>K-474</b>	16 ga., '304' Series S/S Leg with S/S Foot	104 ea.
<b>K-475</b>	S/S Leg with S/S Foot	65 ea.
<b>K-478</b>	Stainless Steel Bullet Foot	26 ea.
<b>K-488</b>	Flanged S/S Bullet Foot	55 ea.
<b>K-493</b>	16 ga., '304' Series S/S Welded Leg Assembly with S/S Feet	346 ea.
<b>K-494</b>	S/S Welded Leg Assembly with S/S Feet	291 ea.
<b>K-497</b>	Galv. Welded Leg Assembly with Plastic Feet	195 ea.
<b>K-497A</b>	Galv. Individual Legs with Plastic Feet	74 set/4
<b>K-496</b>	Leg Assembly For Grease Interceptor w/ Adj. Cross-Bracing & S/S Feet (For Grease Interceptors with 15" Ht. or less. Consult factory for larger Grease Interceptors)	397 ea.
<b>K-610</b>	Perforated Stainless Steel Sink Grid (Specify Bowl Size)	672 ea.

## SINK COVERS

Choose Model # & Add The Proper Letter In Place Of The Underscore (\_).  
Example: K-2A or FC-455H

Bowl Size	FOR DEEP DRAWN BOWLS		FOR FABRICATED BOWLS	
	Poly Covers Model K-2_	S/S Covers Model K-455_	Poly Covers Model K-2_	S/S Covers Model FC-455_
16" x 20"	C \$268	C \$449	CF \$268	C \$449
20" x 20"	E	E	EF	E
24" x 24"	F	F	FF	F
10" x 14"	A	A	AF	A
20" x 28"	G	G	GF	G
14" x 16"	B	B	BF	B
18" x 24"	D	D	DF	D
18" x 18"	Not Available	Not Available	JF	J
20" x 24"	Not Available	Not Available	PF	P
24" x 36"	Not Available	Not Available	RF	R
20" x 30"	Not Available	Not Available	SF	S
24" x 30"	Not Available	Not Available	TF	T
15" x 15"	Not Available	Not Available	MF	M
14" x 14"	H	H	HF	H
12" x 20"	I	I	IF	I

Custom Covers Available. Consult Factory.

### Model # Size Price Tubular KD Wall Mounted Drainage Shelves

<b>DT-6R-36</b>	3"	\$940	• Stainless Steel
<b>DT-6R-48</b>	4"	1088	• 15" Deep
<b>DT-6R-60</b>	5"	1221	• 1-5/8" Diameter Stainless Steel Tubing
<b>DT-6R-72</b>	6"	1338	





# FAUCETS & DRAINS

All Items On This Page Ship Via UPS

For Sinks & Dishtables

## EXTRA HEAVY DUTY FAUCETS

### PRERINSE FAUCETS Wall Bracket Included

**SPEC-LINE HEAVY DUTY Splash Mounted Prerinse Faucet**  
DTA-53 \$823



**Deck Mounted Prerinse Faucet**  
K-115 \$1142

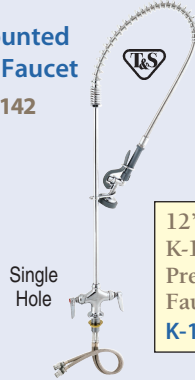

**Splash Mounted Prerinse Faucet**  
K-116 \$1142



12" Add-A-Faucet for DTA-53 Prerinse Faucets  
K-117 \$322



12" Add-A-Faucet for K-115 & K-116 Prerinse Faucets  
K-117-TS \$501



Replacement Hose Handle Not Included

K-113 \$156



Replacement Spray Head & Handle  
K-114 \$177



Model #	Spout Size	T&S Equivalent	Price
K-11	14"	5F-8WLX14	\$261
K-101	8"	5F-8WLX08	205
K-105	14"	B-0230 w/1063X	395
K-112	12"	B-0231	387
K-119	16"	B-0230 W/064X	343
K-211	18"	5f-8WLX18	581

Interchangeable with T&S Brand Faucets. Carton Pricing Available

### POPULAR SPLASH MOUNTED FAUCETS



**Heavy Duty 14" Swing Spout**  
K-111 \$550

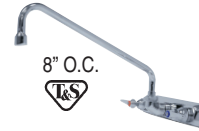

**Wrist Handles for Extra Heavy Duty & Standard 8" O.C. Faucets**  
Splash Mounted K-416-LU \$113



**12" Swing Spout Faucet**  
8" O.C.



Standard K-1 \$223  
T&S Equivalent SF-8WLX12

**Heavy Duty 8" Swing Spout Faucet**  
8" O.C.



Standard K-1118 \$349  
T&S Equivalent B-1126

**Heavy Duty Wall Mounted Service Faucet\***  
8" O.C.



K-240 \$835

**Faucet Wall Mounting Bracket**



K-30 \$323

For use when no backsplash is available to mount faucet

**Low Flow Aerator**  
.5 GPM



K-08 \$25

**Faucet Mounting Kit for K-1, K-11, K-101, K-116, K-119, K-211 & DTA-53**



K-06 \$89 (Set of 2)

**Replacement Cartridges for K-1, K-11, K-101**



K-00B \$98 (Set of 2)

Repair Kit can only be used on faucets purchased after 12/03

**Replacement Cartridges for K-105 & K-112**

K-07 \$119 (Set of 2)

**Vacuum Breaker Repair Kit for K-240**

K-03 \$116



### Replacement Spouts

Model	Spout Size/Style	Price
K-101SP	8" Swing Spout	\$63
K-1SP	12" Swing Spout	75
K-11SP	14" Swing Spout	82
K-211SP	18" Swing Spout	175

**Continuous Waste For 3 Compartment Sink**



K-351 \$322  
1-1/2" Dia.  
For Use with 2 & 3 Compartment Sinks

**Chrome Plated P-Trap**



**Heavy Gauge (17 Gauge) 7-PS-10 \$122**  
**Standard Gauge (22 Gauge) 7-PS-14 \$108**

**Replacement Floor Mop Sink Drain**



K-16 \$161

**Replacement Drains Assembly**

K-6 \$42

**Basket K-310 \$26**

**Strainer Plate for 3-1/2" Drain K-410 \$23**



**Twist Handle Operated Drain**

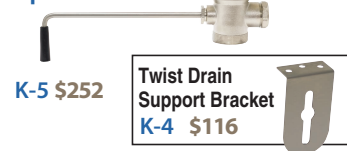

K-5 \$252

**Twist Drain Support Bracket K-4 \$116**

**Twist Handle Operated Drain with Overflow**

K-15 \$447



**SPEC-LINE Twist Handle Operated Drain**

K-40 \$828

All Stainless Steel



**Replacement "O" Rings for Twist Handle Operated Drains**

For K-5 & K-15 Drains

K-05 \$17  
Washer for Twist Handle



**WARNING:** Equipment that includes a faucet may expose you to chemicals, including lead, that are known to the State of California to cause cancer or birth defects or other reproductive harm. For more info., visit www.p65warnings.ca.gov.

\*K-240 Service Faucet Does Not Meet Federal Lead Free Standards As It Is Not Intended For Potable Water.





# FLOOR TROUGHS

## Floor Troughs & Floor Drains

Consult Factory For Additional Sizes  
Custom Sizes Available - Call For Pricing.

Ship Via UPS

- 14 Gauge 304 Stainless Steel
- Stainless Steel Or Fiberglass Grating
- Pitched Towards Waste
- Subway Grating Constructed From 3/16" X 1" Bars
- Grating Is Spaced 9/16" (Inside Clearance) Between Bars To Prevent Casters From Getting Trapped
- Includes 4" Od. - 3" Long Plumbing Sleeve
- Includes Stainless Steel Strainer Basket With Handle

	With S/S Grate	Price	Approx. Weight	With Fiberglass Grate	Price	Approx. Weight	Size W x L x D
12" Width	FTG-1224	\$2798	46 lbs.	FFTG-1224	\$2700	34 lbs.	12" x 24" x 4"
	FTG-1230	2884	56 lbs.	FFTG-1230	2779	37 lbs.	12" x 30" x 4"
	FTG-1236	2973	66 lbs.	FFTG-1236	2858	40 lbs.	12" x 36" x 4"
	FTG-1242	3166	76 lbs.	FFTG-1242	3032	43 lbs.	12" x 42" x 4"
	FTG-1248	3674	86 lbs.	FFTG-1248	3494	46 lbs.	12" x 48" x 4"
	FTG-1254	3988	96 lbs.	FFTG-1254	3779	49 lbs.	12" x 54" x 4"
	FTG-1260	4407	106 lbs.	FFTG-1260	4157	52 lbs.	12" x 60" x 4"
	FTG-1272	5065	116 lbs.	FFTG-1272	4757	55 lbs.	12" x 72" x 4"
	FTG-1284	5948	126 lbs.	FFTG-1284	5557	81 lbs.	12" x 84" x 4"
	FTG-1296*	6123	146 lbs.	FFTG-1296*	5717	90 lbs.	12" x 96" x 4"
	FTG-12108*	6648	166 lbs.	FFTG-12108*	6193	99 lbs.	12" x 108" x 4"
FTG-12120*	8050	180 lbs.	FFTG-12120*	7462	108 lbs.	12" x 120" x 4"	
18" Width	FTG-1824	3147	62 lbs.	FFTG-1824	3017	43 lbs.	18" x 24" x 4"
	FTG-1830	3322	74 lbs.	FFTG-1830	3177	47 lbs.	18" x 30" x 4"
	FTG-1836	3499	86 lbs.	FFTG-1836	3334	54 lbs.	18" x 36" x 4"
	FTG-1842	3744	98 lbs.	FFTG-1842	3560	61 lbs.	18" x 42" x 4"
	FTG-1848	4157	110 lbs.	FFTG-1848	3932	69 lbs.	18" x 48" x 4"
	FTG-1854	4684	122 lbs.	FFTG-1854	4410	76 lbs.	18" x 54" x 4"
	FTG-1860	5135	134 lbs.	FFTG-1860	4817	83 lbs.	18" x 60" x 4"
	FTG-1872	5622	146 lbs.	FFTG-1872	5261	90 lbs.	18" x 72" x 4"
	FTG-1884	6825	165 lbs.	FFTG-1884	6351	111 lbs.	18" x 84" x 4"
	FTG-1896*	6998	187 lbs.	FFTG-1896*	6509	125 lbs.	18" x 96" x 4"
	FTG-18108*	8050	208 lbs.	FFTG-18108*	7462	138 lbs.	18" x 108" x 4"
FTG-18120*	9275	229 lbs.	FFTG-18120*	8575	150 lbs.	18" x 120" x 4"	
24" Width	FTG-2424	3811	69 lbs.	FFTG-2424	3138	52 lbs.	24" x 24" x 4"
	FTG-2430	3969	81 lbs.	FFTG-2430	3414	59 lbs.	24" x 30" x 4"
	FTG-2436	4525	104 lbs.	FFTG-2436	3494	68 lbs.	24" x 36" x 4"
	FTG-2442	4764	118 lbs.	FFTG-2442	3771	75 lbs.	24" x 42" x 4"
	FTG-2448	5239	131 lbs.	FFTG-2448	3969	83 lbs.	24" x 48" x 4"
	FTG-2454	5717	145 lbs.	FFTG-2454	4446	95 lbs.	24" x 54" x 4"
	FTG-2460	5876	162 lbs.	FFTG-2460	4923	102 lbs.	24" x 60" x 4"
	FTG-2472	6830	195 lbs.	FFTG-2472	5398	119 lbs.	24" x 72" x 4"
	FTG-2484	7462	218 lbs.	FFTG-2484	6430	137 lbs.	24" x 84" x 4"
	FTG-2496*	8256	243 lbs.	FFTG-2496*	6590	153 lbs.	24" x 96" x 4"
	FTG-24108*	9371	274 lbs.	FFTG-24108*	7620	168 lbs.	24" x 108" x 4"
FTG-24120*	10004	310 lbs.	FFTG-24120*	8732	188 lbs.	24" x 120" x 4"	

\*96" or Longer Troughs Come with Two Drains

### Floor Trough Accessories & Modifications

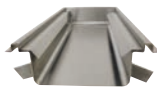

Cut-Out View of Anti-Splash

**FT-1 \$103 lin. ft.**  
Optional Anti-Splash Guard  
(Factory Installed)



**FT-2 \$55 ea.**  
Replacement Stainless Steel  
Strainer Basket with Handle

**FT-3 \$111 lin. ft.**  
Modify Trough Depth  
(2" to 6" Deep)

**FT-4 \$234 per hole**  
Modify Drain Outlet Size  
(Allow 2" to 8" Dia)

**FT-5 \$119 lin. ft.**  
Grate Upgrade to A.D.A.   
(2" to 8" Dia)

**FT-6 No Charge**  
Modify Length of Trough  
(Select Next Larger Size)

### Floor Drains



Includes  
Strainer Basket

Model #	Grate (Not Included)	Approx. Weight	Price	Size W x L x D
FD-1212	Stainless Steel	26 lbs.	\$1400	12" x 12" x 4"

**FD-1**  
Optional Stainless  
Steel Grate \$610



### Floor Water Receptacle



- 14 Gauge 304 Stainless Steel
- Includes Stainless Steel Subway Grating constructed from 3/16" x 1" bars

Model #	Size W x L x D	Price	Approx. Weight
FRG-24	12" x 24" x 2"	\$2704	44 lbs.
FRG-36	12" x 36" x 2"	3083	63 lbs.
FRG-48	12" x 48" x 2"	3572	82 lbs.

# TABLES

## Flat Top W/ Undershef

Stainless Steel TOP  
Stainless Steel UNDERSHELF  
Stainless Steel LEGS



Take Our Tables To  
New Heights!

### ADJUSTABLE TABLE HEIGHT UPGRADE

(Up to 6' tables only. Ships set up.)

- Add To Any Tubular Leg Style Table with Undershef
- Adjust Table Height From 31 1/2" - 40 1/2"
- Easy Turning, Non-Obstructive Fold Away Handle

TA-900  
\$4431 ea.

Up to 40 1/2"  
Max. Ht.  
From Floor

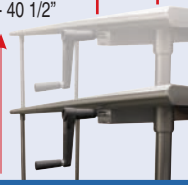

VSS Series  
Countertop Edge

Ship Via UPS



SS, MS, SAG Series  
Bull Nose Edge

### Spec-Line

### Premium

### Standard

### Super Saver

14 Ga. 304 S/S

14 Ga. 304 S/S

16 Ga. 304 S/S

16 Ga. 430 S/S

Length	Spec-Line			Premium			Standard			Super Saver			Approx. Shipping Weight	Approx. Cubic Feet	
	Model #	Price		Model #	Price		Model #	Price		Model #	Price				
<b>24" WIDE</b>	2'	VSS-242	\$1628	SS-242	\$1088	MS-242	\$1008	SAG-242	\$978				31 lbs.	3	
	30"	VSS-240	1750	SS-240	1207	MS-240	1113	SAG-240	1067				49 lbs.	4	
	3'	VSS-243	1810	SS-243	1271	MS-243	1176	SAG-243	1127				64 lbs.	5	
	4'	VSS-244	1864	SS-244	1327	MS-244	1221	SAG-244	1157				79 lbs.	6	
	5'	VSS-245	1987	SS-245	1445	MS-245	1323	SAG-245	1253				92 lbs.	8	
	6'	VSS-246	2107	SS-246	1566	MS-246	1430	SAG-246	1344				109 lbs.	9	
	7'	VSS-247	2605	SS-247	2147	MS-247	1969	SAG-247	1657				130 lbs.	11	
	8'	VSS-248	2755	SS-248	2301	MS-248	2106	SAG-248	1782				145 lbs.	12	
	9'	VSS-249	3238	SS-249	2957	MS-249	2823	SAG-249	2539				161 lbs.	14	
	10'	VSS-2410	3448	SS-2410	3165	MS-2410	2891	SAG-2410	2745				261 lbs.	26	
	11'	VSS-2411	3744	SS-2411	3392	MS-2411	3087	SAG-2411	2910				293 lbs.	29	
	12'	VSS-2412	3819	SS-2412	3466	MS-2412	3163	SAG-2412	2986				308 lbs.	32	
<b>30" WIDE</b>	2'	VSS-302	1750	SS-302	1207	MS-302	1113	SAG-302	1067				55 lbs.	4	
	30"	VSS-300	1822	SS-300	1281	MS-300	1183	SAG-300	1110				65 lbs.	5	
	3'	VSS-303	1885	SS-303	1346	MS-303	1241	SAG-303	1187				72 lbs.	6	
	4'	VSS-304	1962	SS-304	1427	MS-304	1306	SAG-304	1233				89 lbs.	8	
	5'	VSS-305	2109	SS-305	1569	MS-305	1440	SAG-305	1351				107 lbs.	9	
	6'	VSS-306	2337	SS-306	1642	MS-306	1481	SAG-306	1465				126 lbs.	11	
	7'	VSS-307	2693	SS-307	2138	MS-307	1957	SAG-307	1722				148 lbs.	13	
	8'	VSS-308	2804	SS-308	2367	MS-308	2222	SAG-308	1930				166 lbs.	15	
	9'	VSS-309	3550	SS-309	3200	MS-309	2914	SAG-309	2726				176 lbs.	17	
	10'	VSS-3010	3757	SS-3010	3408	MS-3010	3120	SAG-3010	2936				287 lbs.	32	
	11'	VSS-3011	4030	SS-3011	3687	MS-3011	3363	SAG-3011	3145				324 lbs.	35	
	12'	VSS-3012	4106	SS-3012	3764	MS-3012	3441	SAG-3012	3217				339 lbs.	37	
<b>36" WIDE</b>	3'	VSS-363	2246	SS-363	1584	MS-363	1490	SAG-363	1374				88 lbs.	7	
	4'	VSS-364	2291	SS-364	1628	MS-364	1538	SAG-364	1422				98 lbs.	9	
	5'	VSS-365	2462	SS-365	1798	MS-365	1690	SAG-365	1577				118 lbs.	11	
	6'	VSS-366	2641	SS-366	1961	MS-366	1845	SAG-366	1727				138 lbs.	13	
	7'	VSS-367	3225	SS-367	2658	MS-367	2510	SAG-367	2386				164 lbs.	16	
	8'	VSS-368	3426	SS-368	2853	MS-368	2689	SAG-368	2575				184 lbs.	18	
	9'	VSS-369	4171	SS-369	3809	MS-369	3562	SAG-369	3348				190 lbs.	20	
	10'	VSS-3610	4376	SS-3610	4014	MS-3610	3770	SAG-3610	3557				308 lbs.	38	
	11'	VSS-3611	4701	SS-3611	4348	MS-3611	4070	SAG-3611	3813				358 lbs.	41	
	12'	VSS-3612	4777	SS-3612	4417	MS-3612	4143	SAG-3612	3887				373 lbs.	45	
	<b>48" WIDE</b>	4'	VSS-484	4193	SS-484	3255	<b>NOT AVAILABLE</b>							158 lbs.	12
		5'	VSS-485	4538	SS-485	3596									184 lbs.
6'		VSS-486	4874	SS-486	3929									218 lbs.	17
7'		VSS-487	6254	SS-487	5315									260 lbs.	20
8'		VSS-488	6680	SS-488	5735									290 lbs.	23
9'		VSS-489	7743	SS-489	6743									322 lbs.	44
10'		VSS-4810	7875	SS-4810	6874									522 lbs.	49
11'		VSS-4811	8007	SS-4811	7006									601 lbs.	54
12'	VSS-4812	8140	SS-4812	7138					616 lbs.	58					

Featuring as Standard: "THE PROVEN"  
Original ADVANCE TABCO Adjustable  
Undershelf with Die Cast Leg Clamp

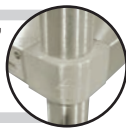

# TABLES

## Flat Top W/ Undershelf



VLG Series  
Countertop Edge



GLG, MG, AG Series  
Bull Nose Edge



Stainless Steel TOP  
Galvanized UNDERSHELF  
Galvanized LEGS

### Spec-Line

### Premium

### Standard

### Super Saver

Length	14 Ga. 304 S/S			14 Ga. 304 S/S			16 Ga. 304 S/S			16 Ga. 430 S/S			Approx. Shipping Weight	Approx. Cubic Feet
	Model #	Price	Model #	Price	Model #	Price	Model #	Price	Model #	Price				
<b>24" WIDE</b>	2'	VLG-242	\$1306	GLG-242	\$780	MG-242	\$744	AG-242	\$694			31 lbs.	3	
	30"	VLG-240	1397	GLG-240	861	MG-240	809	AG-240	755			49 lbs.	4	
	3'	VLG-243	1459	GLG-243	927	MG-243	871	AG-243	818			64 lbs.	5	
	4'	VLG-244	1486	GLG-244	940	MG-244	889	AG-244	835			79 lbs.	6	
	5'	VLG-245	1569	GLG-245	1030	MG-245	962	AG-245	881			92 lbs.	8	
	6'	VLG-246	1668	GLG-246	1119	MG-246	1041	AG-246	940			109 lbs.	9	
	7'	VLG-247	2035	GLG-247	1524	MG-247	1493	AG-247	1201			130 lbs.	11	
	8'	VLG-248	2151	GLG-248	1637	MG-248	1599	AG-248	1368			145 lbs.	12	
	9'	VLG-249	2461	GLG-249	2038	MG-249	1912	AG-249	1831			161 lbs.	14	
	10'	VLG-2410	2672	GLG-2410	2242	MG-2410	2122	AG-2410	2038			261 lbs.	26	
	11'	VLG-2411	2889	GLG-2411	2391	MG-2411	2242	AG-2411	2046			293 lbs.	29	
	12'	VLG-2412	2967	GLG-2412	2468	MG-2412	2317	AG-2412	2123			308 lbs.	32	
<b>30" WIDE</b>	2'	VLG-302	1397	GLG-302	861	MG-302	809	AG-302	755			55 lbs.	4	
	30"	VLG-300	1433	GLG-300	891	MG-300	838	AG-300	773			65 lbs.	5	
	3'	VLG-303	1495	GLG-303	953	MG-303	900	AG-303	837			72 lbs.	6	
	4'	VLG-304	1534	GLG-304	990	MG-304	929	AG-304	852			89 lbs.	8	
	5'	VLG-305	1646	GLG-305	1092	MG-305	1022	AG-305	932			107 lbs.	9	
	6'	VLG-306	1756	GLG-306	1196	MG-306	1119	AG-306	1008			125 lbs.	11	
	7'	VLG-307	2125	GLG-307	1610	MG-307	1516	AG-307	1263			148 lbs.	13	
	8'	VLG-308	2274	GLG-308	1758	MG-308	1649	AG-308	1463			166 lbs.	15	
	9'	VLG-309	2693	GLG-309	2204	MG-309	2065	AG-309	1858			176 lbs.	17	
	10'	VLG-3010	2899	GLG-3010	2406	MG-3010	2275	AG-3010	2068			287 lbs.	32	
	11'	VLG-3011	3090	GLG-3011	2640	MG-3011	2428	AG-3011	2195			324 lbs.	35	
	12'	VLG-3012	3168	GLG-3012	2661	MG-3012	2504	AG-3012	2274			339 lbs.	37	
<b>36" WIDE</b>	3'	VLG-363	1800	GLG-363	1120	MG-363	1082	AG-363	987			88 lbs.	7	
	4'	VLG-364	1847	GLG-364	1161	MG-364	1129	AG-364	1058			98 lbs.	9	
	5'	VLG-365	1988	GLG-365	1306	MG-365	1266	AG-365	1195			118 lbs.	11	
	6'	VLG-366	2122	GLG-366	1421	MG-366	1374	AG-366	1306			138 lbs.	13	
	7'	VLG-367	2558	GLG-367	1920	MG-367	1872	AG-367	1799			164 lbs.	16	
	8'	VLG-368	2681	GLG-368	2039	MG-368	1982	AG-368	1912			184 lbs.	18	
	9'	VLG-369	3197	GLG-369	2659	MG-369	2586	AG-369	2354			190 lbs.	20	
	10'	VLG-3610	3407	GLG-3610	2870	MG-3610	2792	AG-3610	2552			308 lbs.	38	
	11'	VLG-3611	3628	GLG-3611	3112	MG-3611	2997	AG-3611	2716			358 lbs.	41	
	12'	VLG-3612	3706	GLG-3612	3186	MG-3612	3068	AG-3612	2789			373 lbs.	45	
	<b>48" WIDE</b>	4'	VLG-484	3742	GLG-484	2806	<b>NOT AVAILABLE</b>					158 lbs.	12	
		5'	VLG-485	4071	GLG-485	3138						184 lbs.	15	
6'		VLG-486	4340	GLG-486	3142	218 lbs.						17		
7'		VLG-487	5556	GLG-487	4620	260 lbs.						20		
8'		VLG-488	5833	GLG-488	4891	290 lbs.						23		
9'		VLG-489	6843	GLG-489	5847	322 lbs.						44		
10'		VLG-4810	6979	GLG-4810	5979	522 lbs.						49		
11'		VLG-4811	7110	GLG-4811	6112	601 lbs.						54		
12'	VLG-4812	7242	GLG-4812	6242	616 lbs.	58								



# TABLES

## Flat Top W/ Open Base

Stainless Steel TOP  
Stainless Steel LEGS

NSF

**Take Our Tables To New Heights!**

**ADJUSTABLE TABLE HEIGHT UPGRADE**  
(Up to 6' tables only. Ships set up.)

- Add To Any Tubular Leg Style Table with Undershelf
- Adjust Table Height From 31 1/2" - 40 1/2"
- Easy Turning, Non-Obstructive Fold Away Handle

**TA-900**  
**\$4431 ea.**

Up to 40 1/2" Max. Ht. From Floor



TVSS Series  
Countertop Edge



TSS, TMS, TSAG Series  
Bullnose Edge

### Spec-Line

### Premium

### Standard

### Super Saver

14 Ga. 304 S/S      14 Ga. 304 S/S      16 Ga. 304 S/S      16 Ga. 430 S/S

Length	Model #	Price	Model #	Price	Model #	Price	Model #	Price	Approx. Shipping Weight	Approx. Cubic Feet
<b>24" WIDE</b>	2'	TVSS-242 \$1747	TSS-242 \$1204	TMS-242 \$1126	TSAG-242 \$1092	25 lbs.	3			
	30"	TVSS-240 1864	TSS-240 1327	TMS-240 1229	TSAG-240 1184	42 lbs.	4			
	3'	TVSS-243 1930	TSS-243 1390	TMS-243 1290	TSAG-243 1245	53 lbs.	5			
	4'	TVSS-244 1984	TSS-244 1444	TMS-244 1337	TSAG-244 1275	64 lbs.	6			
	5'	TVSS-245 2105	TSS-245 1564	TMS-245 1440	TSAG-245 1363	74 lbs.	8			
	6'	TVSS-246 2229	TSS-246 1685	TMS-246 1550	TSAG-246 1460	85 lbs.	9			
	7'	TVSS-247 2720	TSS-247 2260	TMS-247 2089	TSAG-247 1776	103 lbs.	11			
	8'	TVSS-248 2875	TSS-248 2417	TMS-248 2228	TSAG-248 1898	114 lbs.	12			
	9'	TVSS-249 3364	TSS-249 3084	TMS-249 2811	TSAG-249 2659	130 lbs.	14			
	10'	TVSS-2410 3572	TSS-2410 3291	TMS-2410 3017	TSAG-2410 2870	227 lbs.	26			
	11'	TVSS-2411 3867	TSS-2411 3517	TMS-2411 3215	TSAG-2411 3035	251 lbs.	29			
	12'	TVSS-2412 3945	TSS-2412 3591	TMS-2412 3289	TSAG-2412 3109	266 lbs.	32			
<b>30" WIDE</b>	2'	TVSS-302 1799	TSS-302 1259	TMS-302 1170	TSAG-302 1132	47 lbs.	4			
	30"	TVSS-300 1940	TSS-300 1401	TMS-300 1301	TSAG-300 1238	52 lbs.	5			
	3'	TVSS-303 2002	TSS-303 1463	TMS-303 1359	TSAG-303 1305	59 lbs.	6			
	4'	TVSS-304 2086	TSS-304 1547	TMS-304 1422	TSAG-304 1353	72 lbs.	8			
	5'	TVSS-305 2230	TSS-305 1690	TMS-305 1557	TSAG-305 1469	85 lbs.	9			
	6'	TVSS-306 2454	TSS-306 1838	TMS-306 1685	TSAG-306 1584	93 lbs.	11			
	7'	TVSS-307 2815	TSS-307 2357	TMS-307 2174	TSAG-307 1839	113 lbs.	13			
	8'	TVSS-308 2920	TSS-308 2605	TMS-308 2392	TSAG-308 2046	126 lbs.	15			
	9'	TVSS-309 3676	TSS-309 3326	TMS-309 3037	TSAG-309 2852	150 lbs.	17			
	10'	TVSS-3010 3880	TSS-3010 3530	TMS-3010 3245	TSAG-3010 3062	261 lbs.	32			
	11'	TVSS-3011 4158	TSS-3011 3810	TMS-3011 3486	TSAG-3011 3268	268 lbs.	35			
	12'	TVSS-3012 4231	TSS-3012 3885	TMS-3012 3560	TSAG-3012 3340	283 lbs.	37			
<b>36" WIDE</b>	3'	TVSS-363 2365	TSS-363 1702	TMS-363 1608	TSAG-363 1493	75 lbs.	7			
	4'	TVSS-364 2411	TSS-364 1747	TMS-364 1655	TSAG-364 1545	82 lbs.	9			
	5'	TVSS-365 2582	TSS-365 1913	TMS-365 1807	TSAG-365 1694	96 lbs.	11			
	6'	TVSS-366 2762	TSS-366 2085	TMS-366 1961	TSAG-366 1845	108 lbs.	13			
	7'	TVSS-367 3344	TSS-367 2768	TMS-367 2619	TSAG-367 2507	127 lbs.	16			
	8'	TVSS-368 3544	TSS-368 2974	TMS-368 2811	TSAG-368 2688	140 lbs.	18			
	9'	TVSS-369 4297	TSS-369 3932	TMS-369 3689	TSAG-369 3472	165 lbs.	20			
	10'	TVSS-3610 4501	TSS-3610 4139	TMS-3610 3895	TSAG-3610 3681	261 lbs.	38			
	11'	TVSS-3611 4825	TSS-3611 4462	TMS-3611 4193	TSAG-3611 3941	290 lbs.	41			
	12'	TVSS-3612 4899	TSS-3612 4545	TMS-3612 4273	TSAG-3612 4014	305 lbs.	45			
	<b>48" WIDE</b>	4'	TVSS-484 4311	TSS-484 3369	<b>NOT AVAILABLE</b>		128 lbs.	12		
		5'	TVSS-485 4659	TSS-485 3719			148 lbs.	15		
6'		TVSS-486 4987	TSS-486 4046	170 lbs.			17			
7'		TVSS-487 6374	TSS-487 5431	206 lbs.			20			
8'		TVSS-488 6793	TSS-488 5855	228 lbs.			23			
9'		TVSS-489 7862	TSS-489 6870	260 lbs.			44			
10'		TVSS-4810 7995	TSS-4810 7002	454 lbs.			49			
11'		TVSS-4811 8126	TSS-4811 7134	517 lbs.			54			
12'	TVSS-4812 8260	TSS-4812 7267	532 lbs.	58						

# TABLES

## Flat Top W/ Open Base



TGLG, TMG, TAG Series  
Bullnose Edge



TVLG Series  
Countertop Edge



Stainless Steel TOP  
Galvanized LEGS

### Spec-Line

### Premium

### Standard

### Super Saver

14 Ga. 304 S/S

14 Ga. 304 S/S

16 Ga. 304 S/S

16 Ga. 430 S/S

Approx.  
Shipping  
Weight

Approx.  
Cubic  
Feet

Length	Model #	Price	Model #	Price	Model #	Price	Model #	Price	Approx. Shipping Weight	Approx. Cubic Feet	
<b>24" WIDE</b>	2' TVLG-242	\$1422	TGLG-242	\$894	TMG-242	\$860	TAG-242	\$811	25 lbs.	3	
	30" TVLG-240	1515	TGLG-240	980	TMG-240	929	TAG-240	871	42 lbs.	4	
	3' TVLG-243	1574	TGLG-243	1041	TMG-243	987	TAG-243	935	53 lbs.	5	
	4' TVLG-244	1603	TGLG-244	1060	TMG-244	1000	TAG-244	950	64 lbs.	6	
	5' TVLG-245	1690	TGLG-245	1148	TMG-245	1077	TAG-245	998	74 lbs.	8	
	6' TVLG-246	1785	TGLG-246	1231	TMG-246	1157	TAG-246	1060	85 lbs.	9	
	7' TVLG-247	2154	TGLG-247	1645	TMG-247	1610	TAG-247	1319	103 lbs.	11	
	8' TVLG-248	2268	TGLG-248	1752	TMG-248	1718	TAG-248	1489	114 lbs.	12	
	9' TVLG-249	2586	TGLG-249	2289	TMG-249	2035	TAG-249	1951	130 lbs.	14	
	10' TVLG-2410	2792	TGLG-2410	2498	TMG-2410	2239	TAG-2410	2159	227 lbs.	26	
	11' TVLG-2411	3013	TGLG-2411	2519	TMG-2411	2372	TAG-2411	2169	251 lbs.	29	
	12' TVLG-2412	3088	TGLG-2412	2591	TMG-2412	2448	TAG-2412	2242	266 lbs.	32	
<b>30" WIDE</b>	2' TVLG-302	\$1442	TGLG-302	907	TMG-302	863	TAG-302	819	47 lbs.	4	
	30" TVLG-300	1551	TGLG-300	1008	TMG-300	957	TAG-300	893	52 lbs.	5	
	3' TVLG-303	1611	TGLG-303	1072	TMG-303	1022	TAG-303	955	59 lbs.	6	
	4' TVLG-304	1651	TGLG-304	1112	TMG-304	1044	TAG-304	971	72 lbs.	8	
	5' TVLG-305	1764	TGLG-305	1214	TMG-305	1136	TAG-305	1050	85 lbs.	9	
	6' TVLG-306	1877	TGLG-306	1315	TMG-306	1231	TAG-306	1126	93 lbs.	11	
	7' TVLG-307	2245	TGLG-307	1727	TMG-307	1629	TAG-307	1377	113 lbs.	13	
	8' TVLG-308	2393	TGLG-308	1879	TMG-308	1767	TAG-308	1581	126 lbs.	15	
	9' TVLG-309	2818	TGLG-309	2321	TMG-309	2186	TAG-309	1988	150 lbs.	17	
	10' TVLG-3010	3024	TGLG-3010	2534	TMG-3010	2392	TAG-3010	2195	261 lbs.	32	
	11' TVLG-3011	3217	TGLG-3011	2707	TMG-3011	2551	TAG-3011	2316	268 lbs.	35	
	12' TVLG-3012	3295	TGLG-3012	2784	TMG-3012	2625	TAG-3012	2391	283 lbs.	37	
<b>36" WIDE</b>	3' TVLG-363	1916	TGLG-363	1233	TMG-363	1197	TAG-363	1129	75 lbs.	7	
	4' TVLG-364	1962	TGLG-364	1280	TMG-364	1246	TAG-364	1181	82 lbs.	9	
	5' TVLG-365	2106	TGLG-365	1422	TMG-365	1382	TAG-365	1313	96 lbs.	11	
	6' TVLG-366	2242	TGLG-366	1538	TMG-366	1493	TAG-366	1422	108 lbs.	13	
	7' TVLG-367	2678	TGLG-367	2040	TMG-367	1987	TAG-367	1915	127 lbs.	16	
	8' TVLG-368	2801	TGLG-368	2156	TMG-368	2096	TAG-368	2006	140 lbs.	18	
	9' TVLG-369	3321	TGLG-369	2787	TMG-369	2710	TAG-369	2474	165 lbs.	20	
	10' TVLG-3610	3529	TGLG-3610	2995	TMG-3610	2918	TAG-3610	2679	261 lbs.	38	
	11' TVLG-3611	3757	TGLG-3611	3239	TMG-3611	3120	TAG-3611	2838	290 lbs.	41	
	12' TVLG-3612	3832	TGLG-3612	3313	TMG-3612	3196	TAG-3612	2917	305 lbs.	45	
	<b>48" WIDE</b>	4' TVLG-484	3839	TGLG-484	2921	<b>NOT AVAILABLE</b>				128 lbs.	12
		5' TVLG-485	4193	TGLG-485	3255					148 lbs.	15
6' TVLG-486		4545	TGLG-486	3524	170 lbs.					17	
7' TVLG-487		5678	TGLG-487	4739	206 lbs.					20	
8' TVLG-488		5946	TGLG-488	5006	228 lbs.					23	
9' TVLG-489		6965	TGLG-489	5968	260 lbs.					44	
10' TVLG-4810		7098	TGLG-4810	6101	454 lbs.					49	
11' TVLG-4811		7232	TGLG-4811	6232	517 lbs.					54	
12' TVLG-4812	7364	TGLG-4812	6366	532 lbs.	58						

# TABLES

## 1-1/2" Rear Splash W/ Undershef

Stainless Steel TOP  
Stainless Steel UNDERSHELF  
Stainless Steel LEGS

### Take Our Tables To New Heights!

#### ADJUSTABLE TABLE HEIGHT UPGRADE

(Up to 6' tables only. Ships set up.)

- Add To Any Tubular Leg Style Table with Undershef
- Adjust Table Height From 31 1/2"- 40 1/2"
- Easy Turning, Non-Obstructive Fold Away Handle

**TA-900**

**\$4431 ea.**

Up to 40 1/2"  
Max. Ht.  
From Floor

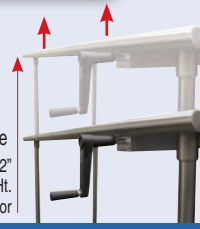

FSS, FMS, SFG Series  
Bullnose Edge

NSF

### Premium

### Standard

### Super Saver

14 Ga. 304 S/S

16 Ga. 304 S/S

16 Ga. 430 S/S

Approx. Shipping Weight  
Approx. Cubic Feet

Length	Model #	Price	Model #	Price	Model #	Price	Approx. Shipping Weight	Approx. Cubic Feet
<b>24" WIDE</b>	2' FSS-242	\$1184	FMS-242	\$1101	SFG-242	\$1073	31 lbs.	3
	30" FSS-240	1305	FMS-240	1202	SFG-240	1158	49 lbs.	4
	3' FSS-243	1363	FMS-243	1266	SFG-243	1226	64 lbs.	5
	4' FSS-244	1421	FMS-244	1311	SFG-244	1255	79 lbs.	6
	5' FSS-245	1545	FMS-245	1415	SFG-245	1344	92 lbs.	8
	6' FSS-246	1663	FMS-246	1520	SFG-246	1436	109 lbs.	9
	7' FSS-247	2240	FMS-247	2060	SFG-247	1751	130 lbs.	11
	8' FSS-248	2392	FMS-248	2195	SFG-248	1879	145 lbs.	12
	9' FSS-249	3055	FMS-249	2787	SFG-249	2641	161 lbs.	14
	10' FSS-2410	3267	FMS-2410	2995	SFG-2410	2841	261 lbs.	26
	11' FSS-2411	3491	FMS-2411	3185	SFG-2411	3008	293 lbs.	29
	12' FSS-2412	3564	FMS-2412	3260	SFG-2412	3086	308 lbs.	32
<b>30" WIDE</b>	2' FSS-302	1231	FMS-302	1149	SFG-302	1113	55 lbs.	4
	30" FSS-300	1374	FMS-300	1275	SFG-300	1223	65 lbs.	5
	3' FSS-303	1436	FMS-303	1340	SFG-303	1280	72 lbs.	6
	4' FSS-304	1519	FMS-304	1401	SFG-304	1328	89 lbs.	8
	5' FSS-305	1668	FMS-305	1531	SFG-305	1444	107 lbs.	9
	6' FSS-306	1816	FMS-306	1663	SFG-306	1559	125 lbs.	11
	7' FSS-307	2337	FMS-307	2149	SFG-307	1819	148 lbs.	13
	8' FSS-308	2577	FMS-308	2372	SFG-308	2021	166 lbs.	15
	9' FSS-309	3306	FMS-309	3014	SFG-309	2831	176 lbs.	17
	10' FSS-3010	3508	FMS-3010	3218	SFG-3010	3035	287 lbs.	32
	11' FSS-3011	3782	FMS-3011	3460	SFG-3011	3244	324 lbs.	35
	12' FSS-3012	3863	FMS-3012	3535	SFG-3012	3316	339 lbs.	37
<b>36" WIDE</b>	3' FSS-363	1677	FMS-363	1587	SFG-363	1470	88 lbs.	7
	4' FSS-364	1722	FMS-364	1629	SFG-364	1517	98 lbs.	9
	5' FSS-365	1891	FMS-365	1785	SFG-365	1672	118 lbs.	11
	6' FSS-366	2054	FMS-366	1940	SFG-366	1822	138 lbs.	13
	7' FSS-367	2751	FMS-367	2605	SFG-367	2478	164 lbs.	16
	8' FSS-368	2954	FMS-368	2785	SFG-368	2666	184 lbs.	18
	9' FSS-369	3908	FMS-369	3659	SFG-369	3446	190 lbs.	20
	10' FSS-3610	4112	FMS-3610	3867	SFG-3610	3657	223 lbs.	38
	11' FSS-3611	4442	FMS-3611	4168	SFG-3611	3911	350 lbs.	41
	12' FSS-3612	4520	FMS-3612	4245	SFG-3612	3990	365 lbs.	45

Units 8 ft. and larger furnished with 6 legs. **SPECIAL LENGTHS:** Select next largest size. Add **Model # TA-61 No Charge** (ex. SS-306 with TA-61 size to 66" long).

**Adjustable Single and Double Table Mounted Overshelves**  
See Pages 68.

**For Adjustable Components Featuring Potracks & Overshelves**  
10", 12" 15" & 18"  
See Page 74 & 75.



Featuring as Standard: "THE PROVEN"  
Original ADVANCE TABCO Adjustable Undershelf  
with Die Cast Leg Clamp

# TABLES

## 1-1/2" Rear Splash W/ Undershelf



FLG, FMG, FAG Series  
Bullnose Edge

Stainless Steel TOP  
Galvanized UNDERSHELF  
Galvanized LEGS

### Premium

### Standard

### Super Saver

14 Ga. 304 S/S

16 Ga. 304 S/S

16 Ga. 430 S/S

Length	Premium			Standard			Super Saver			Approx. Shipping Weight	Approx. Cubic Feet
	Model #	Price	Model #	Price	Model #	Price	Model #	Price			
<b>24" WIDE</b>	2'	FLG-242	\$871	FMG-242	\$837	FAG-242	\$786			31 lbs.	3
	30"	FLG-240	957	FMG-240	900	FAG-240	850			49 lbs.	4
	3'	FLG-243	1022	FMG-243	964	FAG-243	909			64 lbs.	5
	4'	FLG-244	1038	FMG-244	980	FAG-244	922			79 lbs.	6
	5'	FLG-245	1125	FMG-245	1053	FAG-245	977			92 lbs.	8
	6'	FLG-246	1207	FMG-246	1132	FAG-246	1038			109 lbs.	9
	7'	FLG-247	1620	FMG-247	1591	FAG-247	1298			130 lbs.	11
	8'	FLG-248	1728	FMG-248	1694	FAG-248	1465			145 lbs.	12
	9'	FLG-249	2142	FMG-249	2012	FAG-249	1927			161 lbs.	14
	10'	FLG-2410	2345	FMG-2410	2219	FAG-2410	2134			261 lbs.	26
	11'	FLG-2411	2496	FMG-2411	2345	FAG-2411	2187			293 lbs.	29
	12'	FLG-2412	2572	FMG-2412	2422	FAG-2412	2221			308 lbs.	32
<b>30" WIDE</b>	2'	FLG-302	889	FMG-302	840	FAG-302	797			55 lbs.	4
	30"	FLG-300	982	FMG-300	934	FAG-300	868			65 lbs.	5
	3'	FLG-303	1047	FMG-303	994	FAG-303	932			72 lbs.	6
	4'	FLG-304	1083	FMG-304	1020	FAG-304	940			89 lbs.	8
	5'	FLG-305	1190	FMG-305	1119	FAG-305	1023			107 lbs.	9
	6'	FLG-306	1290	FMG-306	1207	FAG-306	1101			125 lbs.	11
	7'	FLG-307	1706	FMG-307	1608	FAG-307	1355			148 lbs.	13
	8'	FLG-308	1855	FMG-308	1744	FAG-308	1557			166 lbs.	15
	9'	FLG-309	2301	FMG-309	2160	FAG-309	1957			176 lbs.	17
	10'	FLG-3010	2506	FMG-3010	2372	FAG-3010	2167			287 lbs.	32
	11'	FLG-3011	2682	FMG-3011	2532	FAG-3011	2290			324 lbs.	35
	12'	FLG-3012	2758	FMG-3012	2605	FAG-3012	2371			339 lbs.	37
<b>36" WIDE</b>	3'	FLG-363	1214	FMG-363	1181	FAG-363	1110			88 lbs.	7
	4'	FLG-364	1260	FMG-364	1227	FAG-364	1153			98 lbs.	9
	5'	FLG-365	1401	FMG-365	1359	FAG-365	1285			118 lbs.	11
	6'	FLG-366	1516	FMG-366	1470	FAG-366	1401			138 lbs.	13
	7'	FLG-367	2018	FMG-367	1961	FAG-367	1892			164 lbs.	16
	8'	FLG-368	2131	FMG-368	2076	FAG-368	2003			184 lbs.	18
	9'	FLG-369	2760	FMG-369	2688	FAG-369	2453			190 lbs.	20
	10'	FLG-3610	2968	FMG-3610	2808	FAG-3610	2659			223 lbs.	38
	11'	FLG-3611	3216	FMG-3611	3092	FAG-3611	2814			350 lbs.	41
	12'	FLG-3612	3291	FMG-3612	3171	FAG-3612	2890			365 lbs.	45

#### SIDE SPLASH



TA-30 1 1/2" Side Splash \$88 ea.  
TA-31 5" Side Splash 165 ea.  
TA-32 10 1/2" Side Splash 323 ea.

#### K.D. ALUMINUM PAN RACK SLIDES

6 Slides - 2" Spacing  
Mounted on Tables (min. length 3")

TA-44  
\$613



Glass Rack Slides  
3 Slides - 7 1/2" Spacing  
TA-45 \$560

#### WORKTABLE CASTERS

When Used with Galvanized Legs

TA-25G-4 \$375/set of 4  
TA-25G-6 562/set of 6

5" Swivels with rubber wheels  
Each set with 2 brakes. Legs  
maintain 35-1/2" working height

TA-25B \$184 For Brakes on all wheels for  
TA-25SG-4 or TA-25G-6

TA-25C X.H.D. Urethane wheels  
\$32 each caster

See Page 62 For More Casters



#### 3 TIER DRAWERS



Stainless Steel

TA-38  
\$3529

20" x 20" x 5"  
Drawer Inserts with  
Ball Bearing Slides

#### URN TROUGH



TA-64  
\$149/lin.ft.

See pages 55-62 for Additional Accessories & Modifications



# TABLES

1-1/2" Rear Splash  
W/ Open Base

Stainless Steel TOP  
Stainless Steel LEGS



Take Our Tables To  
New Heights!

### ADJUSTABLE TABLE HEIGHT UPGRADE

(Up to 6' tables only. Ships set up.)

- Add To Any Tubular Leg Style Table with Undershell
- Adjust Table Height From 31 1/2" - 40 1/2"
- Easy Turning, Non-Obstructive Fold Away Handle

TA-900  
\$4431 ea.

Up to 40 1/2"  
Max. Ht.  
From Floor

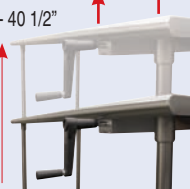

TFSS, TFMS, TSFG Series  
Bullnose Edge

## Premium

## Standard

## Super Saver

14 Ga. 304 S/S

16 Ga. 304 S/S

16 Ga. 430 S/S

Length	Premium			Standard			Super Saver			Approx. Shipping Weight	Approx. Cubic Feet
	Model #	Price	Model #	Price	Model #	Price	Model #	Price			
<b>24" WIDE</b>	2'	TFSS-242	\$1301	TFMS-242	\$1223	TSFG-242	\$1207			25 lbs.	3
	30"	TFSS-240	1421	TFMS-240	1323	TSFG-240	1278			42 lbs.	4
	3'	TFSS-243	1486	TFMS-243	1386	TSFG-243	1342			53 lbs.	5
	4'	TFSS-244	1538	TFMS-244	1430	TSFG-244	1366			64 lbs.	6
	5'	TFSS-245	1657	TFMS-245	1531	TSFG-245	1460			74 lbs.	8
	6'	TFSS-246	1781	TFMS-246	1639	TSFG-246	1555			85 lbs.	9
	7'	TFSS-247	2354	TFMS-247	2178	TSFG-247	1872			103 lbs.	11
	8'	TFSS-248	2512	TFMS-248	2318	TSFG-248	1992			114 lbs.	12
	9'	TFSS-249	3181	TFMS-249	2913	TSFG-249	2760			130 lbs.	14
	10'	TFSS-2410	3391	TFMS-2410	3114	TSFG-2410	2968			227 lbs.	26
	11'	TFSS-2411	3614	TFMS-2411	3311	TSFG-2411	3134			251 lbs.	29
	12'	TFSS-2412	3690	TFMS-2412	3388	TSFG-2412	3193			266 lbs.	32
<b>30" WIDE</b>	2'	TFSS-302	1351	TFMS-302	1266	TSFG-302	1229			47 lbs.	4
	30"	TFSS-300	1450	TFMS-300	1392	TSFG-300	1338			52 lbs.	5
	3'	TFSS-303	1555	TFMS-303	1457	TSFG-303	1398			59 lbs.	6
	4'	TFSS-304	1637	TFMS-304	1517	TSFG-304	1445			72 lbs.	8
	5'	TFSS-305	1785	TFMS-305	1649	TSFG-305	1560			85 lbs.	9
	6'	TFSS-306	1932	TFMS-306	1720	TSFG-306	1677			93 lbs.	11
	7'	TFSS-307	2454	TFMS-307	2267	TSFG-307	1934			113 lbs.	13
	8'	TFSS-308	2689	TFMS-308	2485	TSFG-308	2138			126 lbs.	15
	9'	TFSS-309	3427	TFMS-309	3139	TSFG-309	2955			150 lbs.	17
	10'	TFSS-3010	3628	TFMS-3010	3343	TSFG-3010	3161			242 lbs.	32
	11'	TFSS-3011	3910	TFMS-3011	3581	TSFG-3011	3368			268 lbs.	35
	12'	TFSS-3012	3989	TFMS-3012	3660	TSFG-3012	3444			283 lbs.	37
<b>36" WIDE</b>	3'	TFSS-363	1795	TFMS-363	1704	TSFG-363	1591			70 lbs.	7
	4'	TFSS-364	1839	TFMS-364	1750	TSFG-364	1630			77 lbs.	9
	5'	TFSS-365	2007	TFMS-365	1899	TSFG-365	1787			91 lbs.	11
	6'	TFSS-366	2175	TFMS-366	2054	TSFG-366	1940			103 lbs.	13
	7'	TFSS-367	2870	TFMS-367	2720	TSFG-367	2602			122 lbs.	16
	8'	TFSS-368	3069	TFMS-368	2900	TSFG-368	2784			135 lbs.	18
	9'	TFSS-369	4032	TFMS-369	3781	TSFG-369	3573			160 lbs.	20
	10'	TFSS-3610	4238	TFMS-3610	3992	TSFG-3610	3779			253 lbs.	38
	11'	TFSS-3611	4566	TFMS-3611	4294	TSFG-3611	4040			282 lbs.	41
	12'	TFSS-3612	4643	TFMS-3612	4371	TSFG-3612	4112			297 lbs.	45

Units 8 ft. and larger furnished with 6 legs. SPECIAL LENGTHS: Select next largest size. Add **Model # TA-61 No Charge** (ex. SS-306 with TA-61 size to 66" long).

## SELECTED SPEC-LINE UPGRADES

TA-3	Stainless Steel Hat Channel & Gusset	\$51 /lin. ft.
TA-94	16 ga. S/S 304 Undershell. (any size)	51 /lin. ft.
TA-95	16 ga. S/S 304 Legs	121 /table
TA-23	Welded Set-Up Unit/Crating	382 /table
TA-106	Mirror HI-LITE Edge	395 /table

## WORKTABLE CASTERS

Maintains the 35-1/2" Working Height

TA-25	Castors for Open Base Tables Shown Above (2 w/ Brakes)	\$375 /set of 4
TA-25A	Castors for Open Base Tables shown Above (2 w/ Brakes)	562 /set of 6
TA-25B	Set of Castors with Brakes on All	184 /set (Add to Above)
TA-25C	Upgrade Caster w/ Heavy Duty Urethane Wheels	32 ea. (Add to Above)

See Page 60 for More Caster Options



# TABLES

## 10" & 5" Rear Splash W/ Undershef

Stainless Steel TOP  
Stainless Steel UNDERSHELF  
Stainless Steel LEGS

Take Our Tables To  
New Heights!

### ADJUSTABLE TABLE HEIGHT UPGRADE

(Up to 6' tables only. Ships set up.)

- Add To Any Tubular Leg Style Table with Undershef
- Adjust Table Height From 31 1/2" - 40 1/2"
- Easy Turning, Non-Obstructive Fold Away Handle

TA-900  
\$4431 ea.

Up to 40 1/2"  
Max. Ht.  
From Floor

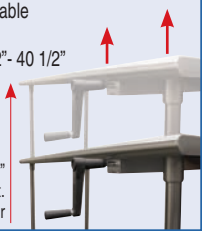

VKS Series  
10" Back Splash  
Countertop Edge



KSS, KMS, SKG Series  
5" Back Splash  
Bullnose Edge



### Spec-Line

### Premium

### Standard

### Super Saver

14 Ga. 304 S/S

14 Ga. 304 S/S

16 Ga. 304 S/S

16 Ga. 430 S/S

Approx.  
Shipping  
Weight

Approx.  
Cubic  
Feet

Length	Model #	Price	Model #	Price	Model #	Price	Model #	Price	Approx. Shipping Weight	Approx. Cubic Feet
<b>24" WIDE</b>	2' VKS-242	\$2052	KSS-242	\$1404	KMS-242	\$1328	SKG-242	\$1262	50 lbs.	5
	30" VKS-240	2175	KSS-240	1526	KMS-240	1433	SKG-240	1416	55 lbs.	6
	3' VKS-243	2240	KSS-243	1592	KMS-243	1495	SKG-243	1477	66 lbs.	7
	4' VKS-244	2297	KSS-244	1655	KMS-244	1550	SKG-244	1513	81 lbs.	9
	5' VKS-245	2415	KSS-245	1782	KMS-245	1663	SKG-245	1603	95 lbs.	12
	6' VKS-246	2535	KSS-246	1912	KMS-246	1781	SKG-246	1700	113 lbs.	14
	7' VKS-247	3023	KSS-247	2454	KMS-247	2287	SKG-247	2011	135 lbs.	16
	8' VKS-248	3176	KSS-248	2612	KMS-248	2433	SKG-248	2135	150 lbs.	18
	9' VKS-249	3695	KSS-249	3327	KMS-249	3065	SKG-249	2913	165 lbs.	21
	10' VKS-2410	3905	KSS-2410	3535	KMS-2410	3273	SKG-2410	3114	268 lbs.	28
	11' VKS-2411	4196	KSS-2411	3779	KMS-2411	3487	SKG-2411	3288	301 lbs.	36
	12' VKS-2412	4274	KSS-2412	3858	KMS-2412	3562	SKG-2412	3360	316 lbs.	39
<b>30" WIDE</b>	2' VKS-302	2106	KSS-302	1450	KMS-302	1359	SKG-302	1366	56 lbs.	6
	30" VKS-300	2248	KSS-300	1606	KMS-300	1498	SKG-300	1476	70 lbs.	7
	3' VKS-303	2312	KSS-303	1666	KMS-303	1564	SKG-303	1541	77 lbs.	9
	4' VKS-304	2391	KSS-304	1752	KMS-304	1630	SKG-304	1591	92 lbs.	11
	5' VKS-305	2537	KSS-305	1908	KMS-305	1779	SKG-305	1704	111 lbs.	14
	6' VKS-306	2682	KSS-306	2066	KMS-306	1916	SKG-306	1810	129 lbs.	17
	7' VKS-307	3121	KSS-307	2546	KMS-307	2372	SKG-307	1992	153 lbs.	20
	8' VKS-308	3358	KSS-308	2800	KMS-308	2605	SKG-308	2280	171 lbs.	22
	9' VKS-309	4005	KSS-309	3573	KMS-309	3281	SKG-309	3101	289 lbs.	25
	10' VKS-3010	4213	KSS-3010	3779	KMS-3010	3496	SKG-3010	3308	294 lbs.	40
	11' VKS-3011	4486	KSS-3011	4072	KMS-3011	3757	SKG-3011	3517	331 lbs.	43
	12' VKS-3012	4563	KSS-3012	4146	KMS-3012	3832	SKG-3012	3591	346 lbs.	47
<b>36" WIDE</b>	3' VKS-363	2677	KSS-363	2016	KMS-363	1877	SKG-363	1727	92 lbs.	10
	4' VKS-364	2722	KSS-364	2060	KMS-364	1918	SKG-364	1776	101 lbs.	14
	5' VKS-365	2896	KSS-365	2323	KMS-365	2167	SKG-365	1930	121 lbs.	17
	6' VKS-366	3073	KSS-366	2495	KMS-366	2321	SKG-366	2085	142 lbs.	20
	7' VKS-367	3657	KSS-367	2974	KMS-367	2764	SKG-367	2736	169 lbs.	23
	8' VKS-368	3855	KSS-368	3184	KMS-368	2958	SKG-368	2924	189 lbs.	27
	9' VKS-369	4616	KSS-369	4258	KMS-369	3920	SKG-369	3726	260 lbs.	30
	10' VKS-3610	4827	KSS-3610	4464	KMS-3610	4127	SKG-3610	3932	315 lbs.	46
	11' VKS-3611	5153	KSS-3611	4806	KMS-3611	4436	SKG-3611	4188	358 lbs.	51
	12' VKS-3612	5231	KSS-3612	4885	KMS-3612	4512	SKG-3612	4266	373 lbs.	55

Units 8 ft. and larger furnished with 6 leg SPECIAL LENGTHS: Select next largest size. Add Model # TA-61 No Charge (ex. SS-306 with TA-61 size to 66" long).



PATENT  
PENDING



### Revolutionary SHD Series Drawer with Integral Drawer Slides

- Stainless Steel Front & Sides
- Self Closing Drawer with Noise Control
- Drawer "Safety Stop" Tab
- Removable Stainless Steel Insert
- Units can be Stacked to Create Tier Drawers

Model #	Insert Size	Price
SHD-2015	20" x 15" x 5"	\$937
SHD-1520	15" x 20" x 5"	937
SHD-2020	20" x 20" x 5"	1001

### DELUXE SERIES

- Stainless Steel Front
- Ball Bearing Slides
- Removable Insert



Stainless Steel			Galvanized		
Model #	Insert Size	Price	Model #	Insert Size	Price
SS-2015	20" x 15" x 5"	\$513	GZ-2015	20" x 15" x 5"	\$365
SS-1520	15" x 20" x 5"	513	GZ-1520	15" x 20" x 5"	365
SS-2020	20" x 20" x 5"	556	GZ-2020	20" x 20" x 5"	398

See Pages 60-61 For More Drawer Details and More Drawer Options!

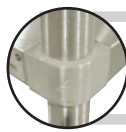

Featuring as Standard: "THE PROVEN"  
Original ADVANCE TABCO Adjustable Undershef  
with Die Cast Leg Clamp



# TABLES

## 10" & 5" Rear Splash W/ Undershef



VKG Series  
10" Back Splash  
Countertop Edge



KLG, KMG, KAG Series  
5" Back Splash  
Bullnose Edge

Stainless Steel TOP  
Galvanized UNDERSHELF  
Galvanized LEGS

### Super Saver

Spec-Line

Premium

Standard

Super Saver

Length	14 Ga. 304 S/S			14 Ga. 304 S/S			16 Ga. 304 S/S			16 Ga. 430 S/S		
	Model #	Price	Model #	Price	Model #	Price	Model #	Price	Approx. Shipping Weight	Approx. Cubic Feet		
<b>24" WIDE</b>	2' VKG-242	\$1798	KLG-242	\$1037	KMG-242	\$1012	KAG-242	\$958	50 lbs.	5		
	30" VKG-240	1892	KLG-240	1126	KMG-240	1092	KAG-240	1023	55 lbs.	6		
	3' VKG-243	1956	KLG-243	1187	KMG-243	1155	KAG-243	1083	66 lbs.	7		
	4' VKG-244	1987	KLG-244	1221	KMG-244	1182	KAG-244	1088	81 lbs.	9		
	5' VKG-245	2086	KLG-245	1306	KMG-245	1266	KAG-245	1161	95 lbs.	12		
	6' VKG-246	2181	KLG-246	1401	KMG-246	1353	KAG-246	1230	113 lbs.	14		
	7' VKG-247	2570	KLG-247	1782	KMG-247	1726	KAG-247	1513	135 lbs.	16		
	8' VKG-248	2693	KLG-248	1899	KMG-248	1860	KAG-248	1685	150 lbs.	18		
	9' VKG-249	3090	KLG-249	2354	KMG-249	2259	KAG-249	2159	165 lbs.	21		
	10' VKG-2410	3298	KLG-2410	2552	KMG-2410	2468	KAG-2410	2371	268 lbs.	28		
	11' VKG-2411	3543	KLG-2411	2650	KMG-2411	2612	KAG-2411	2519	301 lbs.	36		
	12' VKG-2412	3614	KLG-2412	2758	KMG-2412	2686	KAG-2412	2591	316 lbs.	39		
<b>30" WIDE</b>	2' VKG-302	1815	KLG-302	1052	KMG-302	1023	KAG-302	965	56 lbs.	6		
	30" VKG-300	1923	KLG-300	1157	KMG-300	1126	KAG-300	1044	70 lbs.	7		
	3' VKG-303	1912	KLG-303	1224	KMG-303	1187	KAG-303	1106	77 lbs.	9		
	4' VKG-304	2039	KLG-304	1265	KMG-304	1227	KAG-304	1125	92 lbs.	11		
	5' VKG-305	2157	KLG-305	1372	KMG-305	1327	KAG-305	1204	111 lbs.	14		
	6' VKG-306	2272	KLG-306	1486	KMG-306	1434	KAG-306	1283	129 lbs.	17		
	7' VKG-307	2666	KLG-307	1864	KMG-307	1805	KAG-307	1581	153 lbs.	20		
	8' VKG-308	2835	KLG-308	2022	KMG-308	1953	KAG-308	1787	171 lbs.	22		
	9' VKG-309	3341	KLG-309	2510	KMG-309	2410	KAG-309	2312	195 lbs.	25		
	10' VKG-3010	3548	KLG-3010	2716	KMG-3010	2616	KAG-3010	2519	294 lbs.	40		
	11' VKG-3011	3757	KLG-3011	2909	KMG-3011	2792	KAG-3011	2692	331 lbs.	43		
	12' VKG-3012	3832	KLG-3012	2984	KMG-3012	2870	KAG-3012	2763	346 lbs.	47		
<b>36" WIDE</b>	3' VKG-363	2323	KLG-363	1545	KMG-363	1490	KAG-363	1415	92 lbs.	10		
	4' VKG-364	2375	KLG-364	1591	KMG-364	1524	KAG-364	1463	101 lbs.	14		
	5' VKG-365	2525	KLG-365	1747	KMG-365	1690	KAG-365	1587	121 lbs.	17		
	6' VKG-366	2665	KLG-366	1872	KMG-366	1806	KAG-366	1681	142 lbs.	20		
	7' VKG-367	3134	KLG-367	2192	KMG-367	2114	KAG-367	1987	169 lbs.	23		
	8' VKG-368	3262	KLG-368	2461	KMG-368	2380	KAG-368	2238	189 lbs.	27		
	9' VKG-369	3879	KLG-369	3036	KMG-369	2917	KAG-369	2821	260 lbs.	30		
	10' VKG-3610	4084	KLG-3610	3244	KMG-3610	3123	KAG-3610	3030	315 lbs.	46		
	11' VKG-3611	4333	KLG-3611	3466	KMG-3611	3333	KAG-3611	3225	358 lbs.	51		
	12' VKG-3612	4407	KLG-3612	3543	KMG-3612	3408	KAG-3612	3299	373 lbs.	55		

### SIDE SPLASH



TA-30 1 1/2" Side Splash \$88 ea.  
TA-31 5" Side Splash 165 ea.  
TA-32 10 1/2" Side Splash 323 ea.

### K.D. ALUMINUM PAN RACK SLIDES

6 Slides - 2" Spacing  
Mounted on Tables (min. length 3')

TA-44  
\$613



Glass Rack Slides  
3 Slides - 7 1/2" Spacing  
TA-45 \$560

### WORKTABLE CASTERS

When Used with Galvanized Legs

TA-25G-4 \$375/set of 4  
TA-25G-6 562/set of 6

5" Swivels with rubber wheels  
Each set with 2 brakes. Legs  
maintain 35-1/2" working height

TA-25B \$184 For Brakes on all  
wheels for TA-25SG-4 or TA-25G-6

TA-25C X.H.D. Urethane wheels  
\$32 each caster

See Page 62 For More Casters



### 3 TIER DRAWERS



Stainless  
Steel

TA-38  
\$3529

20" x 20" x 5"  
Drawer Inserts with  
Ball Bearing Slides

### URN TROUGH



TA-64  
\$149/lin.ft.

See pages 55-62 for Additional Accessories & Modifications



# TABLES

## 10" & 5" Rear Splash W/ Open Base

Stainless Steel TOP  
Stainless Steel LEGS



**Take Our Tables To  
New Heights!**

**ADJUSTABLE TABLE HEIGHT UPGRADE**  
(Up to 6' tables only. Ships set up.)

- Add To Any Tubular Leg Style Table with Undershef
- Adjust Table Height From 31 1/2" - 40 1/2"
- Easy Turning, Non-Obstructive Fold Away Handle

**TA-900**  
**\$4431 ea.**

Up to 40 1/2" Max. Ht. From Floor

TVKS Series  
10" Back Splash  
Countertop Edge



TKSS, TKMS,  
TSKG Series  
5" Back Splash  
Bullnose Edge

### Spec-Line

### Premium

### Standard

### Super Saver

14 Ga. 304 S/S      14 Ga. 304 S/S      16 Ga. 304 S/S      16 Ga. 430 S/S

Length	Spec-Line		Premium		Standard		Super Saver		Approx. Shipping Weight	Approx. Cubic Feet	
	Model #	Price	Model #	Price	Model #	Price	Model #	Price			
<b>24" WIDE</b>	2'	TVKS-242	\$2174	TKSS-242	\$1519	TKMS-242	\$1445	TSKG-242	\$1445	43 lbs.	5
	30"	TVKS-240	2291	TKSS-240	1646	TKMS-240	1551	TSKG-240	1534	49 lbs.	6
	3'	TVKS-243	2356	TKSS-243	1709	TKMS-243	1611	TSKG-243	1597	55 lbs.	7
	4'	TVKS-244	2413	TKSS-244	1775	TKMS-244	1663	TSKG-244	1627	67 lbs.	9
	5'	TVKS-245	2534	TKSS-245	1898	TKMS-245	1781	TSKG-245	1719	77 lbs.	12
	6'	TVKS-246	2655	TKSS-246	2030	TKMS-246	1896	TSKG-246	1815	89 lbs.	14
	7'	TVKS-247	3141	TKSS-247	2568	TKMS-247	2399	TSKG-247	2125	107 lbs.	16
	8'	TVKS-248	3294	TKSS-248	2730	TKMS-248	2549	TSKG-248	2250	119 lbs.	18
	9'	TVKS-249	3817	TKSS-249	3449	TKMS-249	3186	TSKG-249	3036	135 lbs.	21
	10'	TVKS-2410	4027	TKSS-2410	3660	TKMS-2410	3396	TSKG-2410	3244	234 lbs.	28
	11'	TVKS-2411	4327	TKSS-2411	3906	TKMS-2411	3613	TSKG-2411	3408	258 lbs.	36
	12'	TVKS-2412	4397	TKSS-2412	3981	TKMS-2412	3687	TSKG-2412	3482	273 lbs.	39
<b>30" WIDE</b>	2'	TVKS-302	2228	TKSS-302	1568	TKMS-302	1488	TSKG-302	1488	48 lbs.	6
	30"	TVKS-300	2370	TKSS-300	1720	TKMS-300	1617	TSKG-300	1596	55 lbs.	7
	3'	TVKS-303	2431	TKSS-303	1784	TKMS-303	1681	TSKG-303	1655	62 lbs.	9
	4'	TVKS-304	2511	TKSS-304	1881	TKMS-304	1751	TSKG-304	1706	75 lbs.	11
	5'	TVKS-305	2658	TKSS-305	2029	TKMS-305	1895	TSKG-305	1821	89 lbs.	14
	6'	TVKS-306	2804	TKSS-306	2181	TKMS-306	2035	TSKG-306	1934	97 lbs.	17
	7'	TVKS-307	3241	TKSS-307	2665	TKMS-307	2485	TSKG-307	2192	118 lbs.	20
	8'	TVKS-308	3475	TKSS-308	2915	TKMS-308	2720	TSKG-308	2396	131 lbs.	22
	9'	TVKS-309	4135	TKSS-309	3697	TKMS-309	3411	TSKG-309	3228	150 lbs.	25
	10'	TVKS-3010	4336	TKSS-3010	3906	TKMS-3010	3615	TSKG-3010	3440	249 lbs.	40
	11'	TVKS-3011	4612	TKSS-3011	4198	TKMS-3011	3880	TSKG-3011	3641	276 lbs.	43
	12'	TVKS-3012	4688	TKSS-3012	4275	TKMS-3012	3957	TSKG-3012	3715	291 lbs.	47
<b>36" WIDE</b>	3'	TVKS-363	2794	TKSS-363	2131	TKMS-363	1991	TSKG-363	1845	80 lbs.	10
	4'	TVKS-364	2838	TKSS-364	2178	TKMS-364	2039	TSKG-364	1892	85 lbs.	14
	5'	TVKS-365	3011	TKSS-365	2447	TKMS-365	2282	TSKG-365	2046	99 lbs.	17
	6'	TVKS-366	3188	TKSS-366	2614	TKMS-366	2445	TSKG-366	2194	112 lbs.	20
	7'	TVKS-367	3774	TKSS-367	3094	TKMS-367	2884	TSKG-367	2851	131 lbs.	23
	8'	TVKS-368	3974	TKSS-368	3303	TKMS-368	3078	TSKG-368	3044	145 lbs.	27
	9'	TVKS-369	4741	TKSS-369	4378	TKMS-369	4045	TSKG-369	3845	165 lbs.	30
	10'	TVKS-3610	4953	TKSS-3610	4584	TKMS-3610	4253	TSKG-3610	4053	268 lbs.	46
	11'	TVKS-3611	5280	TKSS-3611	4933	TKMS-3611	4564	TSKG-3611	4312	298 lbs.	51
	12'	TVKS-3612	5352	TKSS-3612	5004	TKMS-3612	4638	TSKG-3612	4389	313 lbs.	55

Units 8 ft. and larger furnished with 6 legs. SPECIAL LENGTHS: Select next largest size. Add **Model # TA-61 No Charge** (ex. SS-306 with TA-61 size to 66" long).

## SELECTED SPEC-LINE UPGRADES

<b>TA-3</b>	Stainless Steel Hat Channel & Gusset	\$51 /lin. ft.
<b>TA-94</b>	16 ga. S/S 304 Undershef. (any size)	51 /lin. ft.
<b>TA-95</b>	16 ga. S/S 304 Legs	121 /table
<b>TA-23</b>	Welded Set-Up Unit/Crating	382 /table
<b>TA-106</b>	Mirror HI-LITE Edge	395 /table

## WORKTABLE CASTERS

Maintains the 35-1/2" Working Height

<b>TA-25</b>	Castors for Open Base Tables Shown Above (2 w/ Brakes)	\$375 /set of 4
<b>TA-25A</b>	Castors for Open Base Tables Shown Above (2 w/ Brakes)	562 /set of 6
<b>TA-25B</b>	Set of Castors with Brakes on All	184 /set (Add to Above)
<b>TA-25C</b>	Upgrade Caster w/ Heavy Duty Urethane Wheels	32 ea. (Add to Above)

See Page 62 for More Caster Options

# TABLES

## 10" & 5" Rear Splash W/ Open Base



TVKG Series  
10" Back Splash  
Countertop Edge



TKLG, TKMG, TKAG Series  
5" Back Splash  
Bullnose Edge



Stainless Steel TOP  
Galvanized LEGS

Length	Spec-Line			Premium			Standard			Super Saver			Approx. Shipping Weight	Approx. Cubic Feet
	Model #	Price	14 Ga. 304 S/S	Model #	Price	14 Ga. 304 S/S	Model #	Price	16 Ga. 304 S/S	Model #	Price	16 Ga. 430 S/S		
<b>24" WIDE</b>	2'	TVKG-242	\$1913	TKLG-242	\$1153	TKMG-242	\$1127	TKAG-242	\$1076				43 lbs.	5
	30"	TVKG-240	2011	TKLG-240	1238	TKMG-240	1214	TKAG-240	1145				49 lbs.	6
	3'	TVKG-243	2074	TKLG-243	1305	TKMG-243	1275	TKAG-243	1202				55 lbs.	7
	4'	TVKG-244	2105	TKLG-244	1337	TKMG-244	1298	TKAG-244	1231				67 lbs.	9
	5'	TVKG-245	2195	TKLG-245	1422	TKMG-245	1382	TKAG-245	1281				77 lbs.	12
	6'	TVKG-246	2301	TKLG-246	1517	TKMG-246	1470	TKAG-246	1350				89 lbs.	14
	7'	TVKG-247	2686	TKLG-247	1898	TKMG-247	1840	TKAG-247	1627				107 lbs.	16
	8'	TVKG-248	2815	TKLG-248	2021	TKMG-248	1957	TKAG-248	1805				119 lbs.	18
	9'	TVKG-249	3218	TKLG-249	2474	TKMG-249	2386	TKAG-249	2288				135 lbs.	21
	10'	TVKG-2410	3420	TKLG-2410	2679	TKMG-2410	2591	TKAG-2410	2496				234 lbs.	28
	11'	TVKG-2411	3664	TKLG-2411	2837	TKMG-2411	2739	TKAG-2411	2643				258 lbs.	36
	12'	TVKG-2412	3738	TKLG-2412	2912	TKMG-2412	2813	TKAG-2412	2716				273 lbs.	39
<b>30" WIDE</b>	2'	TVKG-302	1931	TKLG-302	1167	TKMG-302	1145	TKAG-302	1082				48 lbs.	6
	30"	TVKG-300	2041	TKLG-300	1275	TKMG-300	1238	TKAG-300	1158				55 lbs.	7
	3'	TVKG-303	2105	TKLG-303	1340	TKMG-303	1305	TKAG-303	1226				62 lbs.	9
	4'	TVKG-304	2156	TKLG-304	1381	TKMG-304	1343	TKAG-304	1236				75 lbs.	11
	5'	TVKG-305	2272	TKLG-305	1490	TKMG-305	1444	TKAG-305	1324				89 lbs.	14
	6'	TVKG-306	2392	TKLG-306	1603	TKMG-306	1552	TKAG-306	1405				97 lbs.	17
	7'	TVKG-307	2784	TKLG-307	1984	TKMG-307	1918	TKAG-307	1701				118 lbs.	20
	8'	TVKG-308	2954	TKLG-308	2138	TKMG-308	2073	TKAG-308	1905				131 lbs.	22
	9'	TVKG-309	3469	TKLG-309	2632	TKMG-309	2538	TKAG-309	2438				150 lbs.	25
	10'	TVKG-3010	3672	TKLG-3010	2838	TKMG-3010	2744	TKAG-3010	2643				249 lbs.	40
	11'	TVKG-3011	3880	TKLG-3011	3033	TKMG-3011	2918	TKAG-3011	2814				276 lbs.	43
	12'	TVKG-3012	3957	TKLG-3012	3107	TKMG-3012	2995	TKAG-3012	2890				291 lbs.	47
<b>36" WIDE</b>	3'	TVKG-363	2447	TKLG-363	1593	TKMG-363	1550	TKAG-363	1535				80 lbs.	10
	4'	TVKG-364	2486	TKLG-364	1639	TKMG-364	1593	TKAG-364	1581				85 lbs.	14
	5'	TVKG-365	2639	TKLG-365	1862	TKMG-365	1807	TKAG-365	1704				99 lbs.	17
	6'	TVKG-366	2783	TKLG-366	1987	TKMG-366	1920	TKAG-366	1799				112 lbs.	20
	7'	TVKG-367	3250	TKLG-367	2312	TKMG-367	2239	TKAG-367	2105				131 lbs.	23
	8'	TVKG-368	3380	TKLG-368	2579	TKMG-368	2495	TKAG-368	2346				145 lbs.	27
	9'	TVKG-369	4000	TKLG-369	3163	TKMG-369	3042	TKAG-369	2949				165 lbs.	30
	10'	TVKG-3610	4206	TKLG-3610	3368	TKMG-3610	3250	TKAG-3610	3150				268 lbs.	46
	11'	TVKG-3611	4455	TKLG-3611	3591	TKMG-3611	3458	TKAG-3611	3352				298 lbs.	51
	12'	TVKG-3612	4528	TKLG-3612	3664	TKMG-3612	3530	TKAG-3612	3421				313 lbs.	55

### Put a Sink in Your Table!



\* Only Installed In Tables 30" Wide or Wider  
\*\* Bowls Are Turned with 16" F to B on 24" Wide Tables  
† K-50 Swing Spout Faucet (Double Bowl)

Size	Single Bowl		Double Bowl	
	Model#	Price	Model#	Price
10" x 14" x 5"	TA-11Q	\$1036	TA-11Q-2	\$1893
10" x 14" x 10"	TA-11F	1115	TA-11F-2†	2133
16" x 20" x 8"	TA-11A**	1167	TA-11A-2**	2169
16" x 20" x 12"	TA-11B**	1304	TA-11B-2**	2393
16" x 20" x 14"	TA-11V**	1515	TA-11V-2**	2570
20" x 20" x 8"	TA-11C**	1230	TA-11C-2**	2380
20" x 20" x 12"	TA-11D*	1400	TA-11D-2*	2519
20" x 20" x 14"	TA-11W**	1635	TA-11W-2**	2690
14" x 16" x 12"	TA-11J	1173	TA-11J-2	2195
18" x 24" x 14"	TA-11L	1345	TA-11L-2	2417
18" x 18" x 14"	TA-11N	1329	TA-11N-2	2397
20" x 24" x 14"	TA-11P	1428	TA-11P-2	2564
20" x 30" x 14"	TA-11S*	1557	TA-11S-2*	2903
24" x 24" x 14"	TA-11E*	1468	TA-11E-2*	2758
24" x 30" x 14"	TA-11T*	1603	TA-11T-2*	3054
24" x 36" x 14"	TA-11R*	1655	TA-11R-2*	3100

### POLY-VANCE 5/8" THICK CUTTING BOARDS

Model #	Description	Price
K-2A	Cutting Board For 10"x14" Bowls	\$268 ea.
K-2B	Cutting Board For 14"x16" Bowls	268 ea.
K-2C	Cutting Board For 16"x20" Bowls	268 ea.
K-2D	Cutting Board For 18"x24" Bowls	268 ea.
K-2E	Cutting Board For 20"x20" Bowls	268 ea.
K-2F	Cutting Board For 24"x24" Bowls	268 ea.
K-2J	Cutting Board For 18"x18" Bowls	268 ea.
K-2K	Cutting Board For 30"x24" Bowls	268 ea.

For Faucets & Accessories - See Page 30

# TABLES

## Enclosed Base Tables



**\*Please add "M" after model number when adding Fixed Mid Shelf & refer to prices below**

FLAT TOP  
UNITS



### Open Base

### Sliding Doors

### Hinged Doors

Length	Model #	w/ Fixed Mid-Shelf (Add "M")		Model #	# of Doors	w/ Fixed Mid-Shelf (Add "M")		Model #	# of Doors	w/ Fixed Mid-Shelf (Add "M")		Approx. Cubic Feet
<b>24" WIDE</b>	3'	EB-SS-243	\$2587 M \$3089	NOT AVAILABLE			HB-SS-243	2	\$4082 M \$4585		30	
	4'	EB-SS-244	2684 M 3182	CB-SS-244	2	\$3693 M \$4194	HB-SS-244	2	4278 M 4776		38	
	5'	EB-SS-245	2873 M 3431	CB-SS-245	2	3969 M 4530	HB-SS-245	2	4561 M 5119		47	
	6'	EB-SS-246	3063 M 3693	CB-SS-246	2	4255 M 4887	HB-SS-246	4	4838 M 5468		56	
	7'	EB-SS-247	3334 M 4035	CB-SS-247	4	4865 M 5568	HB-SS-247	4	5445 M 6149		66	
	8'	EB-SS-248	3504 M 4259	CB-SS-248	4	5256 M 6016	HB-SS-248	4	5843 M 6600		74	
	9'	EB-SS-249	3970 M 4851	CB-SS-249	4	5891 M 6774	HB-SS-249	4	6479 M 7362		83	
	10'	EB-SS-2410	4152 M 5031	CB-SS-2410	4	6075 M 6951	HB-SS-2410	4	6658 M 7539		92	
12'	EB-SS-2412	5737 M 6437	CB-SS-2412	4	7437 M 8461	HB-SS-2412	6	8995 M 10112		109		
<b>30" WIDE</b>	3'	EB-SS-303	2728 M 3299	NOT AVAILABLE			HB-SS-303	2	4224 M 4743		35	
	4'	EB-SS-304	2825 M 3398	CB-SS-304	2	3833 M 4405	HB-SS-304	2	4412 M 4986		45	
	5'	EB-SS-305	3037 M 3693	CB-SS-305	2	4136 M 4790	HB-SS-305	2	4727 M 5382		55	
	6'	EB-SS-306	3254 M 3981	CB-SS-306	2	4444 M 5171	HB-SS-306	4	5032 M 5759		66	
	7'	EB-SS-307	3476 M 4285	CB-SS-307	4	4999 M 5810	HB-SS-307	4	5586 M 6395		76	
	8'	EB-SS-308	3839 M 4742	CB-SS-308	4	5474 M 6379	HB-SS-308	4	6059 M 6963		87	
	9'	EB-SS-309	4233 M 5287	CB-SS-309	4	6150 M 7208	HB-SS-309	4	6740 M 7801		97	
	10'	EB-SS-3010	4411 M 5467	CB-SS-3010	4	6330 M 7386	HB-SS-3010	4	6920 M 7982		107	
12'	EB-SS-3012	6082 M 6779	CB-SS-3012	4	8230 M 9518	HB-SS-3012	6	9468 M 10582		128		
<b>36" WIDE</b>	3'	EB-SS-363	2923 M 3557	NOT AVAILABLE			HB-SS-363	2	4526 M 5156		41	
	4'	EB-SS-364	3017 M 3651	CB-SS-364	2	4089 M 4725	HB-SS-364	2	4718 M 5349		53	
	5'	EB-SS-365	3245 M 3982	CB-SS-365	2	4415 M 5155	HB-SS-365	2	5046 M 5786		65	
	6'	EB-SS-366	3627 M 4464	CB-SS-366	2	4746 M 5580	HB-SS-366	4	5375 M 6210		77	
	7'	EB-SS-367	3710 M 4650	CB-SS-367	4	5341 M 6283	HB-SS-367	4	5966 M 6911		90	
	8'	EB-SS-368	4101 M 5086	CB-SS-368	4	5851 M 6837	HB-SS-368	4	6471 M 7457		102	
	9'	EB-SS-369	4534 M 5769	CB-SS-369	4	6584 M 7819	HB-SS-369	4	7213 M 8445		114	
	10'	EB-SS-3610	4716 M 5951	CB-SS-3610	4	6761 M 7999	HB-SS-3610	4	7393 M 8628		126	
12'	EB-SS-3612	6202 M 7301	CB-SS-3612	4	8730 M 10130	HB-SS-3612	6	10254 M 11496		151		

## 1-1/2" BACKSPASH UNITS

### Open Base

### Sliding Doors

### Hinged Doors

Length	Model #	w/ Fixed Mid-Shelf (Add "M")		Model #	# of Doors	w/ Fixed Mid-Shelf (Add "M")		Model #	# of Doors	w/ Fixed Mid-Shelf (Add "M")		Approx. Cubic Feet
<b>24" WIDE</b>	3'	EF-SS-243	\$2587 M \$3089	NOT AVAILABLE			HF-SS-243	2	\$4082 M \$4585		30	
	4'	EF-SS-244	2684 M 3182	CF-SS-244	2	\$3693 M \$4194	HF-SS-244	2	4278 M 4776		38	
	5'	EF-SS-245	2873 M 3431	CF-SS-245	2	3969 M 4530	HF-SS-245	2	4561 M 5119		47	
	6'	EF-SS-246	3063 M 3693	CF-SS-246	2	4255 M 4887	HF-SS-246	4	4838 M 5468		56	
	7'	EF-SS-247	3334 M 4035	CF-SS-247	4	4865 M 5568	HF-SS-247	4	5445 M 6149		66	
	8'	EF-SS-248	3504 M 4259	CF-SS-248	4	5256 M 6016	HF-SS-248	4	5843 M 6600		74	
	9'	EF-SS-249	3970 M 4851	CF-SS-249	4	5891 M 6774	HF-SS-249	4	6479 M 7362		83	
	10'	EF-SS-2410	4152 M 5031	CF-SS-2410	4	6075 M 6951	HF-SS-2410	4	6658 M 7539		92	
12'	EF-SS-2412	5737 M 6437	CF-SS-2412	4	7437 M 8461	HF-SS-2412	6	8995 M 10112		109		
<b>30" WIDE</b>	3'	EF-SS-303	2728 M 3299	NOT AVAILABLE			HF-SS-303	2	4224 M 4793		35	
	4'	EF-SS-304	2825 M 3398	CF-SS-304	2	3833 M 4405	HF-SS-304	2	4412 M 4986		45	
	5'	EF-SS-305	3037 M 3693	CF-SS-305	2	4136 M 4790	HF-SS-305	2	4727 M 5382		55	
	6'	EF-SS-306	3252 M 3981	CF-SS-306	2	4444 M 5171	HF-SS-306	4	5032 M 5759		66	
	7'	EF-SS-307	3476 M 4285	CF-SS-307	4	4999 M 5810	HF-SS-307	4	5586 M 6395		76	
	8'	EF-SS-308	3839 M 4742	CF-SS-308	4	5474 M 6379	HF-SS-308	4	6059 M 6963		87	
	9'	EF-SS-309	4233 M 5287	CF-SS-309	4	6150 M 7208	HF-SS-309	4	6740 M 7795		97	
	10'	EF-SS-3010	4411 M 5467	CF-SS-3010	4	6330 M 7386	HF-SS-3010	4	6920 M 7976		107	
12'	EF-SS-3012	6082 M 6779	CF-SS-3012	4	8230 M 9518	HF-SS-3012	6	9468 M 10582		128		

(Approx. Shipping Weight Is 50 Lbs. Per Lineal Foot)

**Call For Installation of Buyout Equipment!**

FOR 36" WIDE 1-1/2" SPLASH UNITS: Use 36" Flat Top Price and Replace "B" with "F" (Example: EB-SS-364 would change to read EF-SS-364)

**\*Please add "M" after model number when adding Fixed Mid Shelf & refer to prices below**



# TABLES

## Enclosed Base Tables

5"  
BACKSPASH  
UNITS



**Open Base**

**Sliding Doors**

**Hinged Doors**

Length	Model #	w/ Fixed Mid-Shelf (Add "M")		Model #	# of Doors	w/ Fixed Mid-Shelf (Add "M")		Model #	# of Doors	w/ Fixed Mid-Shelf (Add "M")		Approx. Cubic Feet
<b>24" WIDE</b>	3'	EK-SS-243	\$2669 M \$3118		NOT AVAILABLE			HK-SS-243	2	\$4168 M \$4670	30	
	4'	EK-SS-244	2766 M 3212	CK-SS-244	2	\$3773 M \$4278		HK-SS-244	2	4361 M 4861	38	
	5'	EK-SS-245	2960 M 3468	CK-SS-245	2	4060 M 4623		HK-SS-245	2	4643 M 5212	47	
	6'	EK-SS-246	3158 M 3735	CK-SS-246	2	4354 M 5026		HK-SS-246	4	4937 M 5571	56	
	7'	EK-SS-247	3438 M 4012	CK-SS-247	4	4965 M 5671		HK-SS-247	4	5551 M 6261	66	
	8'	EK-SS-248	3614 M 4313	CK-SS-248	4	5363 M 6121		HK-SS-248	4	5955 M 6712	74	
	9'	EK-SS-249	4098 M 4922	CK-SS-249	4	6018 M 6894		HK-SS-249	4	6602 M 7484	83	
	10'	EK-SS-2410	4280 M 5100	CK-SS-2410	4	6198 M 7077		HK-SS-2410	4	6783 M 7665	92	
	12'	EK-SS-2412	5876 M 6776	CK-SS-2412	4	8101 M 9081		HK-SS-2412	6	9171 M 10255	109	
	<b>30" WIDE</b>	3'	EK-SS-303	2899 M 3382		NOT AVAILABLE			HK-SS-303	2	4304 M 4878	35
4'		EK-SS-304	2905 M 3477	CK-SS-304	2	3913 M 4484		HK-SS-304	2	4500 M 5072	45	
5'		EK-SS-305	3154 M 3811	CK-SS-305	2	4228 M 4886		HK-SS-305	2	4812 M 5471	55	
6'		EK-SS-306	3294 M 4023	CK-SS-306	2	4541 M 5271		HK-SS-306	4	5126 M 5855	66	
7'		EK-SS-307	3576 M 4390	CK-SS-307	4	5104 M 5911		HK-SS-307	4	5694 M 7439	76	
8'		EK-SS-308	3950 M 4850	CK-SS-308	4	5583 M 6486		HK-SS-308	4	6536 M 7488	87	
9'		EK-SS-309	4355 M 5469	CK-SS-309	4	6277 M 7338		HK-SS-309	4	6865 M 7917	97	
10'		EK-SS-3010	4540 M 5586	CK-SS-3010	4	6460 M 7514		HK-SS-3010	4	7043 M 8243	107	
12'		EK-SS-3012	6200 M 7100	CK-SS-3012	4	8650 M 9803		HK-SS-3012	6	9922 M 11008	128	
<b>36" WIDE</b>		3'	EK-SS-363	3008 M 3636		NOT AVAILABLE			HK-SS-363	2	4608 M 5240	41
	4'	EK-SS-364	3104 M 3733	CK-SS-364	2	4175 M 4807		HK-SS-364	2	4803 M 5432	53	
	5'	EK-SS-365	3318 M 4125	CK-SS-365	2	4515 M 5249		HK-SS-365	2	5136 M 5873	65	
	6'	EK-SS-366	3716 M 4558	CK-SS-366	2	4847 M 5682		HK-SS-366	4	5472 M 6303	77	
	7'	EK-SS-367	3819 M 4754	CK-SS-367	4	5448 M 6390		HK-SS-367	4	6078 M 7016	90	
	8'	EK-SS-368	4214 M 5200	CK-SS-368	4	5962 M 6947		HK-SS-368	4	6980 M 7969	102	
	9'	EK-SS-369	5047 M 5843	CK-SS-369	4	6713 M 7948		HK-SS-369	4	7286 M 8517	114	
	10'	EK-SS-3610	5468 M 6021	CK-SS-3610	4	6837 M 8070		HK-SS-3610	4	7464 M 8695	126	
	12'	EK-SS-3612	6445 M 7633	CK-SS-3612	4	9273 M 10443		HK-SS-3612	6	10568 M 11713	151	

(approx. shipping weight is 75 lbs. per lineal foot)

For Enclosed Base Tables Over 12' Add The Following:

TA-65	Open Base Units	\$475 /lin. ft.
TA-66	Sliding Door Units	692 /lin. ft.
TA-67	Hinged Door Units	733 /lin. ft.

**We Recommend a Welded Field Joint For Units Over 12'**

**TA-57 \$245 ea.**

(Units over 14' require a Welded or Bolted Field Joint)

### ENCLOSED BASE MODIFICATIONS & ACCESSORIES

TA-255P	Four 5" Heavy Duty Bolt-On Casters .....	\$606 set/4
TA-255AP	Six 5" Heavy Duty Bolt-On Casters .....	884 set/6
TA-19L	Replacement Bolt-on Leg w/ Flanged Foot .....	72 ea.
TA-46	Door Lock .....	283 ea.
TA-54	Removable Kick Plate .....	148 /lin. ft.
TA-130	Cutlery Dispenser Holder .....	215 /lin. ft.
TA-135	Plate Shelf .....	257 /lin. ft.



**CASH-1 \$1027 ea.**  
Undermount Cash Drawer



**TA-20L \$63 ea.**  
Replacement Bolt-On Leg

### ADJUSTABLE MID SHELVES FOR ENCLOSED BASE TABLES

#### TA-116 ADJUSTABLE ENCLOSED BASE CABINET MID SHELF \$762 Per Section

Add To Price of Enclosed Base Table with Fixed Mid Shelf (M).

Shelves Over 36" In Length Require Multiple Sections With Center Partition.

For Partial Shelves Add to Price of Shelf on Page 62.

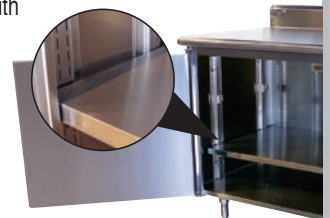



# TABLES

## Enclosed Base Tables

NSF



**30" Wide Units!**

Featuring SHD Series NSF Drawers

## ENCLOSED BASE TABLES WITH DRAWERS



Hinged Doors



Sliding Doors

Length	w/ Hinged Door		w/ Sliding Doors		# of Drawers	# of Doors	Weight	Cubic Feet
	Model #	Price	Model #	Price				
60"	<a href="#">HDRC-305</a>	<b>\$6951</b>	<a href="#">SDRC-305</a>	<b>\$6842</b>	2	2	300 lbs.	55
72"	<a href="#">HDRC-306</a>	<b>7416</b>	<a href="#">SDRC-306</a>	<b>7295</b>	2	4	360 lbs.	66
84"	<a href="#">HDRC-307</a>	<b>8915</b>	<a href="#">SDRC-307</a>	<b>8827</b>	3	4	420 lbs.	76
96"	<a href="#">HDRC-308</a>	<b>9079</b>	<a href="#">SDRC-308</a>	<b>8918</b>	3	4	540 lbs.	87
120"	<a href="#">HDRC-3010</a>	<b>11476</b>	<a href="#">SDRC-3010</a>	<b>11385</b>	4	4	600 lbs.	107

### ACCESSORIES

<a href="#">TA-105</a>	Modified to 24" Width	<b>\$291</b> /table	<a href="#">TA-14</a>	Drawer Lock	<b>\$122</b> ea.
<a href="#">TA-110</a>	Modified to 36" Width	<b>55</b> /lin. ft.	<a href="#">TA-46</a>	Door Lock	<b>283</b> ea.



## DISH CABINETS

NSF

Model #	Option	Price
<a href="#">TA-101</a>	Rear Tray Lock	<b>\$88</b> /lin. ft.
<a href="#">TA-61</a>	Special Sizing Charge (From Next Larger Size)	<b>N/C</b>

Length	15" WIDE				18" WIDE			
	Model #	Weight	Cu. Ft.	Price	Model #	Weight	Cu. Ft.	Price
48"	<a href="#">DC-154</a>	155 lbs.	21	<b>\$2689</b>	<a href="#">DC-184</a>	170 lbs.	25	<b>\$2870</b>
60"	<a href="#">DC-155</a>	195 lbs.	27	<b>2874</b>	<a href="#">DC-185</a>	205 lbs.	31	<b>3104</b>
72"	<a href="#">DC-156</a>	225 lbs.	32	<b>3196</b>	<a href="#">DC-186</a>	245 lbs.	36	<b>3801</b>
84"	<a href="#">DC-157</a>	265 lbs.	37	<b>3331</b>	<a href="#">DC-187</a>	275 lbs.	41	<b>4103</b>
96"	<a href="#">DC-158</a>	295 lbs.	42	<b>3578</b>	<a href="#">DC-188</a>	315 lbs.	46	<b>4412</b>
120"	<a href="#">DC-1510</a>	360 lbs.	52	<b>4392</b>	<a href="#">DC-1810</a>	385 lbs.	56	<b>4992</b>
144"	<a href="#">DC-1512</a>	400 lbs.	62	<b>4523</b>	<a href="#">DC-1812</a>	425 lbs.	66	<b>5127</b>

**30" Wide Units!**

NSF

## BEVERAGE TABLES



TA-56  
5" NSF

Includes K-60  
Splash Mounted Faucet



Model BEV-30-72L Shown

Length	Model #	Price	Weight	Cu. Ft.
4'	<a href="#">BEV-30-48LorR*</a>	<b>\$6012</b>	230 lbs.	37
5'	<a href="#">BEV-30-60LorR*</a>	<b>6384</b>	250 lbs.	45
6'	<a href="#">BEV-30-72LorR*</a>	<b>6787</b>	270 lbs.	54
7'	<a href="#">BEV-30-84LorR*</a>	<b>7770</b>	290 lbs.	63
8'	<a href="#">BEV-30-96LorR*</a>	<b>8262</b>	330 lbs.	71
9'	<a href="#">BEV-30-108LorR*</a>	<b>12407</b>	360 lbs.	76
10'	<a href="#">BEV-30-120LorR*</a>	<b>12451</b>	380 lbs.	88
12'	<a href="#">BEV-30-144LorR*</a>	<b>12607</b>	430 lbs.	96

Specify Sink Left Or Right End:

\*Please Designate Left Or Right Sink Location By Using L Or R After Model Number When Ordering.

**Sink Size 14" x 16" x 12"**

Customize Your Own Beverage Table  
with Additional Accessories on Pages 55-62

[TA-45](#) Optional Glass Rack Slide **\$560**

**Call For Installation of Buyout Equipment!**

# SINK CABINETS

## Sink Cabinets

### SELF-CONTAINED MOBILE HAND SINKS NSF

Bring The Sink On Location When Hand Washing Is Needed!

- 16 Ga., 304 Stainless Steel Top.
- K-52 Deck Mt. Gooseneck Faucet.
- Door Latch.
- 4" Plate Casters - 2 with Brakes.
- Hinged Door.
- Operates on a 120 Volt/15 Amp Circuit.
- 2-1/2" Gallon Electric Hot Water Heater (See Models Below).
- 6 Ft. Power Cord.
- Removable Plastic Container(s) for Fresh Water.
- Removable Plastic Container(s) for Waste Water.



Optional Custom Vinyl Wrap Design.  
CALL TO LEARN MORE!



SHK-MSC-26C Shown

w/ Cold Water Supply Only				w/ Hot & Cold Water Supply				Size L x W	Sink Bowl	Capacity (Gal.) Fresh/Waste
Model #	Dry Weight	Cu. Ft.	Price	Model #	Dry Weight	Cu. Ft.	Price			
SHK-MSC-26C	165 lbs.	21	\$6380	SHK-MSC-26CH	175 lbs.	21	\$6772	26" x 26"	10" x 14" x 5"	5/7
SHK-MSC-31C	185 lbs.	25	6603	SHK-MSC-31CH	195 lbs.	25	7169	31" x 26"	10" x 14" x 5"	10/14

#### SELF-CONTAINED MOBILE HAND SINK ACCESSORIES & MODIFICATIONS



TA-MSC-1 Shown

- TA-MSC-1 Bolt-on Towel/Soap Dispenser w/ Drip Tray for 26" Unit **\$649**
- TA-MSC-2 Bolt-on Towel/Soap Dispenser w/ Drip Tray for 31" Unit **862**
- TA-MSC-PC 10 ft. Power Cord **232**
- TA-46 Door Lock **283**
- K-12 Deck Mounted Soap Dispenser **137**
- K-316-LU Wrist Handles For Faucet **109**

### CORNER SINK CABINET NSF

- Furnished With A 5" Splash With A 1" Return.
- SHK-2441 Designed To Line Up With "HK" 5" Rear Splash Enclosed Base Tables To Create Functional Work Area.
- Door Is A Double Panel Design.
- Utility Access Clearance Provided For Ease Of Plumbing Installation.
- Includes Sink With K-124 6" Extended Spout Faucet & Drain.
- Mitered Front Permits Easy Access To Sink Bowl & Faucet.



SHK-2441 Shown with Enclosed Base Line-Up.  
For Enclosed Base Table Options, See Pages 44-46.

Model #	Size L x W	Sink Bowl	Weight	Cu. Ft.	Price
<b>SHK-1735</b>	17" x 35"	14" x 10" x 10"	215 lbs.	38	<b>\$4938</b>
<b>SHK-2441</b>	24" x 41"	16" x 20" x 12"	250 lbs.	50	<b>5434</b>

### STANDARD SINK CABINET NSF

- 5" Splash With A 1" Return On The Rear Side.
- Includes Sink And K-124 6" Extended Faucet & Drain.
- Hinged Door.

Model #	Size L x W	Sink Bowl	Dry Weight	Cu. Ft.	Price
<b>SHK-302</b>	24" x 30"	10" x 14" x 10"	150 lbs.	30	<b>\$4322</b>
<b>Space Saver Sink Cabinet</b>					
<b>SHK-180</b>	18" x 30"	10" x 14" x 10"	125 lbs.	30	<b>3952</b>



Add a 5" SIDE SPLASH  
TA-31 \$165 ea.

# WALL CABINETS

## 15" WIDE STAINLESS STEEL WALL CABINETS

18 Gauge, 430 Stainless Steel  
Includes Fixed Mid-Shelf



SLIDING  
DOOR



OPEN  
UNIT



HINGED  
DOORS

Size L x W x H	W/ SLIDING DOORS				OPEN UNIT			W/ HINGED DOORS				Approx. Cu. Ft.
	Model #	Price	Doors	Approx. Weight	Model #	Price	Approx. Weight	Model #	Price	Doors	Approx. Weight	
36" x 15" x 32-1/2"	NOT AVAILABLE				WCO-15-36	\$3235	95 lbs.	WCH-15-36	\$4769	2	120 lbs.	17
48" x 15" x 32-1/2"	WCS-15-48	\$4853	2	155 lbs.	WCO-15-48	3727	120 lbs.	WCH-15-48	5166	2	150 lbs.	21
60" x 15" x 32-1/2"	WCS-15-60	5610	2	185 lbs.	WCO-15-60	4069	145 lbs.	WCH-15-60	5914	2	180 lbs.	26
72" x 15" x 32-1/2"	WCS-15-72	6093	2	220 lbs.	WCO-15-72	4919	180 lbs.	WCH-15-72	6059	2	240 lbs.	31
96" x 15" x 32-1/2"	WCS-15-96	7657	4	295 lbs.	WCO-15-96	5274	240 lbs.	WCH-15-96	6851	4	320 lbs.	41

## STORAGE CABINETS



### 84" High Storage Cabinet w/ 4 Fixed Mid-Shelves

- Single Left-Hinged Door\*
- 4 Fixed Stainless Steel Mid-Shelves
- Enclosed Back Panel  
Ventilation Slots

Overall Size: 25"L x 22-5/8"W x 84"H

**CAB-4 \$5542**  
18 Gauge, 430 Stainless Steel

**CAB-4-300 \$6085**  
18 Gauge, 300 Stainless Steel



Vented  
Side Panels



### Wall Mounted Chemical Storage Cabinet w/ 1 Fixed Mid-Shelf

- Left-Hinged Door\*
- Vented Side Panels
- Mounting Hardware Not Included

Overall Size: 24"L x 15"W x 32-1/2"H

**WCH-15-24 \$4021**

18 Gauge, 430 Stainless Steel

**WCH-15-24-300 \$4455**

18 Gauge, 300 Stainless Steel

WCH-15-24 Left Hinged  
Shown (Standard)

\*Optional Right-Hand Door Swing Available - Add CAB-R N/C

## CABINET ACCESSORIES & MODIFICATIONS



Adjustable Mid-Shelf

**TA-115 \$126 per lin. ft.**  
Add to Price of 84" High Storage  
Cabinets or Wall Cabinets



Additional Fixed Mid-Shelf

**WC-SHELF \$82 per lin. ft.**    **K-94-SHELF \$338 ea.**  
For WCS, WCO, WCH Series    For 84" High Storage Cabinet  
Wall Cabinets

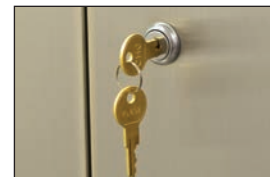

Cabinet Door Lock

**TA-46 \$283**  
One Per Hinged Door or  
Pair of Sliding Doors

# SPECIALTY TABLES

## Specialty Tables

### DEMO TABLE

Countertop Edge Mirror Tilts to Desired Position



Model #	Table Size	Mirror Size	Wt.	Cu.	Price
VSS-DT-365	36" x 60"	24" x 48"	275 lbs.	18	\$7308
VSS-DT-366	36" x 72"	24" x 60"	305 lbs.	23	8604

### CEILING MOUNTED DEMO MIRROR

- 16 ga. type 304 Stainless Steel
- 1 5/8" Tubing - 4' Posts
- 14 ga. Rainbow Uprights For Added Support
- Glass Mirror



Model #	Mirror Size	Wt.	Cu.	Price
MI-48	24" x 48"	91 lbs.	7	\$4107
MI-60	24" x 60"	115 lbs.	8	4819

Mirror Tilts to Desired Position

PRINT REQUIRED

### CORNER TABLES 14 Gauge, 304 Stainless Steel

5" Rear Splash (1" Return)

Length	24" WIDE		30" WIDE		Wt.	Cu. Ft.
	Model #	Price	Model #	Price		
5'	KTMS-245	\$6232	KTMS-305	\$6361	280 lbs.	30
6'	KTMS-246	6361	KTMS-306	6487	300 lbs.	35
7'	KTMS-247	6487	KTMS-307	6614	320 lbs.	40
8'	KTMS-248	6614	KTMS-308	6740	345 lbs.	45
9'	KTMS-249	6740	KTMS-309	6869	375 lbs.	50
10'	KTMS-2410	6869	KTMS-3010	6997	400 lbs.	55
11'	KTMS-2411	6997	KTMS-3011	7123	425 lbs.	60
12'	KTMS-2412	7250	KTMS-3012	7378	450 lbs.	65

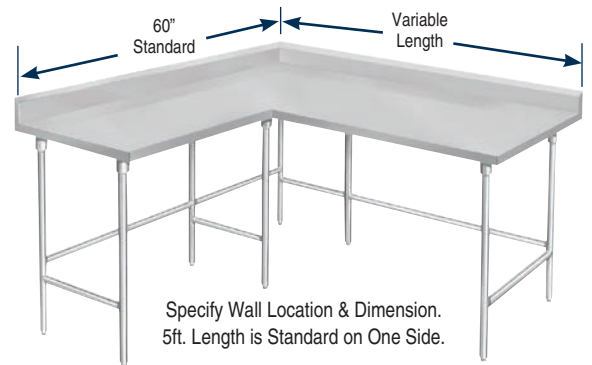

Specify Wall Location & Dimension. 5ft. Length is Standard on One Side.

(Length can be modified, but not to exceed 7 ft. on one wall dimension)

TA-57 \$245 Prepare Welded Field Joint

### Accessories

KT-100	36" Width On Corner Tables	\$130 /lin. ft.	KT-103	Stainless Steel Undershef	\$55 /lin. ft.
KT-101	Additional Length in Excess of 5'	154 /lin. ft.	KT-104	Stainless Steel Cabinet Base	332 /lin. ft.
KT-102	Special Sizing Charge	N/C		(Top Is Shipped Separately For Ease In Installation)	

### WORK TABLE WITH PREP SINK & FAUCET



- 16 ga., 304 Stainless Steel Top
- 5" Rear Splash
- 16" x 20" x 12" Sink Bowl
- Stainless Steel Adjustable Undershef
- 4 O.C. Deck Mounted Faucet & Basket Drain Included
- Stainless Steel Legs & Bullet Feet

Model #	Size	Price
KMS-11B-305L	30"x60"	\$3491
KMS-11B-305R	30"x60"	3491
KMS-11B-306L	30"x72"	3609
KMS-11B-306R	30"x72"	3609

CHOOSE LEFT OR RIGHT SINK POSITION

### PREP TABLE WITH COUNTERTOP EDGE



- 10" Rear Splash
- Includes 1 - 16" x 20" x 8" & 1 - 16" x 20" x 4" Integrally Welded Stainless Steel Sinks
- 21" x 18" x 5/8" Poly-Vance Cutting Board
- Stainless Steel Die-Formed Drawer
- Includes K-55 4" O.C. Gooseneck Faucet.

Model #	Size	Weight	Cu. Ft.	Price
DL-30-72	30" x 72"	155 lbs.	36	\$5592
DL-30-96	30" x 96"	198 lbs.	47	6239

See Page 59 For Additional Integral Sink Sizes



# MIXER TABLES

Mixer Tables



Ship Via UPS

## MIXER TABLE WITH UTENSIL RACK

24" Work Height to Top of Table (Utensil Rack Has Height of 78")

Size	Stainless Steel Base		Galvanized Base		Wt.	Cu. Ft.
24 x 24	MX-SS-242	\$1818	MX-GL-242	\$1576	53 lbs.	3
24 x 30	MX-SS-302	1882	MX-GL-302	1610	63 lbs.	4
30 x 30	MX-SS-300	2020	MX-GL-300	1722	70 lbs.	5
30 x 36	MX-SS-303	2048	MX-GL-303	1745	77 lbs.	6
36 x 36	MX-SS-363	2104	MX-GL-363	1801	81 lbs.	7

MX-SS-242  
Shown  
Mixer Not Included



## MIXER TABLE WITH UNDERSHELF

24" Work Height

Size	Stainless Steel Base		Galvanized Base		Wt.	Cu. Ft.
24 x 24	MT-SS-242	\$1089	MT-GL-242	\$895	45 lbs.	3
24 x 30	MT-SS-302	1144	MT-GL-302	934	50 lbs.	4
30 x 30	MT-SS-300	1296	MT-GL-300	1041	55 lbs.	5
30 x 36	MT-SS-303	1316	MT-GL-303	1070	68 lbs.	6
36 x 36	MT-SS-363	1380	MT-GL-363	1118	71 lbs.	7

MT-SS-242  
Shown



## BUDGET MIXER TABLES

24" Work Height

Size	Stainless Steel Base		Galvanized Base		Wt.	Cu. Ft.
24 x 24	SAG-MT-242	\$984	AG-MT-242	\$799	38 lbs.	3
24 x 30	SAG-MT-302	1033	AG-MT-302	820	41 lbs.	4
30 x 30	SAG-MT-300	1055	AG-MT-300	837	52 lbs.	5
30 x 36	SAG-MT-303	1125	AG-MT-303	879	58 lbs.	6
36 x 36	SAG-MT-363	1188	AG-MT-363	939	64 lbs.	7

AG-MT-242  
Shown



## MOBILE MIXER TABLES WITH TRAY SLIDES & CASTERS

28" Work Height. Tray Slides Have 2" Spacing

Size	Stainless Steel Base		Galvanized Base		Wt.	Cu. Ft.
30 x 30	MT-MS-300	\$1915	MT-MG-300	\$1663	85 lbs.	9
30 x 36	MT-MS-303	1939	MT-MG-303	1691	95 lbs.	10

MT-MG-300  
Shown



## MIXER EQUIPMENT TABLE

28" Work Height

Size	Model #	Price	Wt.	Cu. Ft.
24" x 30"	AG-MP-30	\$1629	65 lbs.	4

Add 15" x 20" Drawer [SS-1520](#) \$513

Shown with  
Optional Drawer



### CASTERS

MAINTAINS 24" WORKING HEIGHT

5" Swivels Each Set with 2 Brakes

For Use with  
Stainless Steel Legs

[TA-25ES](#) \$375 set/4

For Use with  
Galvanized Legs

[TA-25EG](#) \$375 set/4

## WALL MOUNTED TABLES



Must Be Installed In Cinder Block Wall  
Or Equal For Necessary Support



- Rolled Rim
- 1 1/2" Backsplash

24"  
WIDE

Length	Model #	Price
30"	FSS-W-240	\$1383
24"	FSS-W-242	1255
36"	FSS-W-243	1383
48"	FSS-W-244	1499
60"	FSS-W-245	1637
72"	FSS-W-246	1764
84"	FSS-W-247	2376
96"	FSS-W-248	2538

30"  
WIDE

Length	Model #	Price
30"	FSS-W-300	\$1455
24"	FSS-W-302	1306
36"	FSS-W-303	1497
48"	FSS-W-304	1609
60"	FSS-W-305	1768
72"	FSS-W-306	1923
84"	FSS-W-307	2474
96"	FSS-W-308	2730



Ship Via UPS

# STANDS

## Equipment Stands

### EQUIPMENT STANDS WITH UNDERSHELF NSF

24" Working Height • 14 Ga. Type 304 Series • Up to 1000 lb. Load Capacity



Optional  
Heavy Duty Casters

TA-255 Set of 4 \$513

TA-256 Set of 6 680

Each set supplied with  
2 Brakes

Length	Stainless Steel				Galvanized				Wt.	Cu. Ft.
	24" WIDE	Price	30" WIDE	Price	24" WIDE	Price	30" WIDE	Price		
2'	ES-242	\$1167	ES-302	\$1220	EG-242	\$1022	EG-302	\$1046	43 lbs.	4
3'	ES-243	1294	ES-303	1368	EG-243	1128	EG-303	1169	56 lbs.	6
4'	ES-244	1418	ES-304	1521	EG-244	1267	EG-304	1301	74 lbs.	8
5'	ES-245	1547	ES-305	1679	EG-245	1340	EG-305	1432	84 lbs.	9
6'	ES-246	1673	ES-306	1828	EG-246	1446	EG-306	1560	102 lbs.	11
7'	ES-247	2088	ES-307	2803	EG-247	1771	EG-307	2433	120 lbs.	13
8'	ES-248	2134	ES-308	2850	EG-248	1817	EG-308	2482	135 lbs.	15

For 36" Wide Equipment Stands Add TA-59 277 per table

NSF

new

### EQUIPMENT STANDS WITH UNDERSHELF & CASTERS

24" Working Height • 14 Ga. Type 304 Stainless Steel • Up to 1000 lb. Load Capacity



Includes Four 5" Swivel Casters,  
Two with Brakes

Length	30" WIDE	Price	Wt.	Cu. Ft.
2'	ES-302C	\$1696	51 lbs.	4
3'	ES-303C	1841	68 lbs.	6
4'	ES-304C	1990	85 lbs.	8
5'	ES-305C	2143	102 lbs.	9
6'	ES-306C	2288	119 lbs.	11



Wood Top Cutting Board  
w/ Plate Shelf\*

\*Must Order Cutting Board When  
Ordering Plate Shelf



Stainless Steel  
Cutting Surface

#### Optional Equipment Stand Accessories

L	Adj. S/S Cutting Surface		Adj. Wood Cutting Board		Adj. S/S Plate Shelf		Wt.	Cu. Ft.
	Model #	Price	Model #	Price	Model #	Price		
2'	TA-812	\$434	TA-922	\$464	TA-962	\$448	28 lbs.	1
3'	TA-813	649	TA-923	524	TA-963	507	30 lbs.	2
4'	TA-814	868	TA-924	588	TA-964	559	34 lbs.	3
5'	TA-815	1082	TA-925	650	TA-965	620	37 lbs.	3
6'	TA-816	1302	TA-926	716	TA-966	677	40 lbs.	4
7'	TA-817	1518	TA-927	842	TA-967	843	56 lbs.	5
8'	TA-818	1737	TA-928	963	TA-968	981	64 lbs.	5

### EQUIPMENT FILLER TABLES NSF

- Heavy Gauge Stainless Steel
- 1-1/2" Backsplash
- Stainless Steel Legs
- Stainless Steel Adjustable Bullet Feet

#### Open Base

Size	Model #	Price	Wt.	Cu. Ft.
12" x 24"	TFMS-122	\$835	22 lbs.	2
12" x 30"	TFMS-120	904	31 lbs.	2
12" x 36"	TFMS-123	963	39 lbs.	2
15" x 24"	TFMS-152	918	25 lbs.	2
15" x 30"	TFMS-150	1001	33 lbs.	2
15" x 36"	TFMS-153	1058	41 lbs.	3
18" x 24"	TFMS-182	925	27 lbs.	2
18" x 30"	TFMS-180	1012	35 lbs.	3
18" x 36"	TFMS-183	1046	43 lbs.	3



All Filler Tables Must Be Placed Between  
2 Other Pieces Of Equipment For Stability.

#### w/ Adjustable Stainless Steel Undershelf

Size	Model #	Price	Wt.	Cu. Ft.
15" x 24"	TFMSU-152	\$1157	28 lbs.	2
15" x 30"	TFMSU-150	1182	36 lbs.	2
18" x 24"	TFMSU-182	1348	38 lbs.	2
18" x 30"	TFMSU-180	1285	41 lbs.	2



# WOOD TOPS

## Wood Top Bakers Tables



All Wood Top Bakers Tables  
On Page 52 & 53 Feature  
1-3/4" Thick Wood Top



= Ship Via UPS

### FLAT TOP - OPEN BASE STYLE

#### Stainless Steel Base

L	24" WIDE	Price	Wt. (lbs.)	Cu. Ft.	30" WIDE	Price	Wt. (lbs.)	Cu. Ft.	36" WIDE	Price	Wt. (lbs.)	Cu. Ft.
4'	TH2S-244	\$1112	80	6	TH2S-304	\$1274	100	7	TH2S-364	\$1694	115	8
5'	TH2S-245	1246	95	7	TH2S-305	1451	120	9	TH2S-365	1932	135	11
6'	TH2S-246	1387	115	9	TH2S-306	1628	140	11	TH2S-366	2174	155	13
7'	TH2S-247	1706	135	10	TH2S-307	2042	155	12	TH2S-367	2720	180	15
8'	TH2S-248	1731	155	12	TH2S-308	2275	185	14	TH2S-368	2957	215	17



#### Galvanized Base

L	24" WIDE	Price	Wt. (lbs.)	Cu. Ft.	30" WIDE	Price	Wt. (lbs.)	Cu. Ft.	36" WIDE	Price	Wt. (lbs.)	Cu. Ft.
4'	TH2G-244	\$874	80	6	TH2G-304	\$977	100	7	TH2G-364	\$1169	115	8
5'	TH2G-245	966	95	7	TH2G-305	1102	120	9	TH2G-365	1302	135	11
6'	TH2G-246	1058	115	9	TH2G-306	1222	140	11	TH2G-366	1426	155	13
7'	TH2G-247	1289	135	10	TH2G-307	1524	155	12	TH2G-367	1872	180	15
8'	TH2G-248	1517	155	12	TH2G-308	1761	185	14	TH2G-368	1897	215	17

### FLAT TOP - WITH ADJUSTABLE UNDERSHELF

#### Stainless Steel Base

L	24" WIDE	Price	Wt. (lbs.)	Cu. Ft.	30" WIDE	Price	Wt. (lbs.)	Cu. Ft.	36" WIDE	Price	Wt. (lbs.)	Cu. Ft.
3'	H2S-243	\$1112	75	4	H2S-303	\$1269	90	5	H2S-363	\$1674	105	6
4'	H2S-244	1183	95	6	H2S-304	1343	115	7	H2S-364	1742	135	8
5'	H2S-245	1343	110	7	H2S-305	1536	140	9	H2S-365	2003	160	11
6'	H2S-246	1499	130	9	H2S-306	1737	160	11	H2S-366	2256	185	13
7'	H2S-247	1861	150	10	H2S-307	2188	185	12	H2S-367	2846	215	15
8'	H2S-248	2095	180	12	H2S-308	2420	215	14	H2S-368	3081	255	17



#### Galvanized Base

L	24" WIDE	Price	Wt. (lbs.)	Cu. Ft.	30" WIDE	Price	Wt. (lbs.)	Cu. Ft.	36" WIDE	Price	Wt. (lbs.)	Cu. Ft.
3'	H2G-243	\$913	75	4	H2G-303	\$1015	90	5	H2G-363	\$1208	105	6
4'	H2G-244	982	95	6	H2G-304	1083	115	7	H2G-364	1279	135	8
5'	H2G-245	1104	110	7	H2G-305	1230	140	9	H2G-365	1436	160	11
6'	H2G-246	1225	130	9	H2G-306	1377	160	11	H2G-366	1592	185	13
7'	H2G-247	1502	150	10	H2G-307	1742	185	12	H2G-367	1954	215	15
8'	H2G-248	1735	180	12	H2G-308	1976	215	14	H2G-368	2188	255	17

### COVED TOP W/ 4" SPLASH - OPEN BASE STYLE

Features Coved Risers & Allow For Easy Cleaning

#### Stainless Steel Base

Length	30" WIDE	Price	Wt.	Cu. Ft.	36" WIDE	Price	Wt.	Cu. Ft.
4'	TBS-304	\$2497	120	12	TBS-364	\$3283	120	14
5'	TBS-305	2665	150	15	TBS-365	3513	150	18
6'	TBS-306	3127	180	18	TBS-366	4009	180	21
7'	TBS-307	3792	210	21	TBS-367	5003	210	24
8'	TBS-308	4021	240	24	TBS-368	5235	240	28



#### Galvanized Base

Length	30" WIDE	Price	Wt.	Cu. Ft.	36" WIDE	Price	Wt.	Cu. Ft.
4'	TBG-304	\$1895	120	12	TBG-364	\$2497	120	14
5'	TBG-305	2029	150	15	TBG-365	2687	150	18
6'	TBG-306	2437	180	18	TBG-366	3218	180	21
7'	TBG-307	3110	210	21	TBG-367	4116	210	24
8'	TBG-308	3341	240	24	TBG-368	4349	240	28

For Special Sizes & Configurations Of  
Wood Top Tables, Consult Factory.

For Additional Accessories & Modifications  
See Page 55 - 62 for Details



Coved Risers &  
Allow For Easy Cleaning!



# WOOD TOPS

## Wood Top Tables

### COVED TOP W/ 4" SPLASH & ADJUSTABLE UNDERSHELF



#### Stainless Steel Base

L	30" WIDE	Price	Wt.	Cu. Ft.	36" WIDE	Price	Wt. (lbs.)	Cu. Ft.
4'	BS-304	\$2610	160	15	BS-364	\$3396	190	17
5'	BS-305	2808	185	18	BS-365	3655	220	21
6'	BS-306	3211	225	21	BS-366	4245	265	25
7'	BS-307	4014	240	25	BS-367	5231	290	29
8'	BS-308	4245	275	28	BS-368	5462	350	33

#### Galvanized Base

L	30" WIDE	Price	Wt.	Cu. Ft.	36" WIDE	Price	Wt. (lbs.)	Cu. Ft.
4'	BG-304	\$2008	160	15	BG-364	\$2610	190	17
5'	BG-305	2170	185	18	BG-365	2821	220	21
6'	BG-306	2608	225	21	BG-366	3394	265	25
7'	BG-307	3336	240	25	BG-367	4341	290	29
8'	BG-308	3569	275	28	BG-368	4574	350	33

### COVED TOP W/ 4" SPLASH & 3-TIER DRAWERS



BST-306L Shown

#### Stainless Steel Base

L	30" WIDE	Price	Wt.	Cu. Ft.	36" WIDE	Price	Wt. (lbs.)	Cu. Ft.
4'	BST-304LorR	\$4161	365	46	BST-364LorR	\$5484	390	54
5'	BST-305LorR	4430	400	56	BST-365LorR	5757	430	66
6'	BST-306LorR	4774	440	67	BST-366LorR	6209	475	78
7'	BST-307LorR	5068	465	77	BST-367LorR	7032	505	91
8'	BST-308LorR	5297	500	87	BST-368LorR	7281	560	103

#### Galvanized Base

L	30" WIDE	Price	Wt.	Cu. Ft.	36" WIDE	Price	Wt. (lbs.)	Cu. Ft.
4'	BGT-304LorR	\$3605	365	46	BGT-364LorR	\$4714	390	54
5'	BGT-305LorR	3739	400	56	BGT-365LorR	4865	430	66
6'	BGT-306LorR	4177	440	67	BGT-366LorR	5373	475	78
7'	BGT-307LorR	4893	465	77	BGT-367LorR	6216	505	91
8'	BGT-308LorR	5126	500	87	BGT-368LorR	6509	560	103

# COUNTERTOPS



- 16 Gauge Type 304 S/S
- #4 Satin Finish
- No-Drip "Mirror Hi-Lite Polish" Edge

- Stud Welded Hat Channel
- Sound Deadening

Countertop Shown  
with Optional Side Splash  
& Sink Bowl



Size	Flat Top	Price	Approx. Wt.	Approx. Cu. Ft.	5" Backsplash	Price	Approx. Wt.	Approx. Cu. Ft.	10" Backsplash	Price	Approx. Wt.	Approx. Cu. Ft.
25" x 30"	VCTC-240	\$1114	28 lbs.	4	VCTF-240	\$1251	28 lbs.	4	VKCT-240	\$1392	28 lbs.	4
25" x 36"	VCTC-243	1114	39 lbs.	5	VCTF-243	1251	39 lbs.	5	VKCT-243	1392	39 lbs.	5
25" x 48"	VCTC-244	1230	49 lbs.	6	VCTF-244	1374	49 lbs.	6	VKCT-244	1531	49 lbs.	6
25" x 60"	VCTC-245	1353	58 lbs.	8	VCTF-245	1496	58 lbs.	8	VKCT-245	1665	58 lbs.	8
25" x 72"	VCTC-246	1470	68 lbs.	9	VCTF-246	1625	68 lbs.	9	VKCT-246	1805	68 lbs.	9
25" x 84"	VCTC-247	1819	85 lbs.	11	VCTF-247	1948	85 lbs.	11	VKCT-247	2165	85 lbs.	11
25" x 96"	VCTC-248	1951	95 lbs.	12	VCTF-248	2087	95 lbs.	12	VKCT-248	2313	95 lbs.	12
25" x 120"	VCTC-2410	2670	201 lbs.	26	VCTF-2410	2846	201 lbs.	26	VKCT-2410	3160	201 lbs.	26
30" x 30"	VCTC-300	1197	38 lbs.	5	VCTF-300	1315	38 lbs.	5	VKCT-300	1462	38 lbs.	5
30" x 36"	VCTC-303	1197	45 lbs.	6	VCTF-303	1315	45 lbs.	6	VKCT-303	1462	45 lbs.	6
30" x 48"	VCTC-304	1327	57 lbs.	8	VCTF-304	1464	57 lbs.	8	VKCT-304	1637	57 lbs.	8
30" x 60"	VCTC-305	1477	69 lbs.	9	VCTF-305	1619	69 lbs.	9	VKCT-305	1799	69 lbs.	9
30" x 72"	VCTC-306	1665	76 lbs.	11	VCTF-306	1767	76 lbs.	11	VKCT-306	1964	76 lbs.	11
30" x 84"	VCTC-307	1917	95 lbs.	13	VCTF-307	2040	95 lbs.	13	VKCT-307	2269	95 lbs.	13
30" x 96"	VCTC-308	2075	107 lbs.	15	VCTF-308	2090	107 lbs.	15	VKCT-308	2506	107 lbs.	15
30" x 120"	VCTC-3010	2981	235 lbs.	32	VCTF-3010	3049	235 lbs.	32	VKCT-3010	3394	235 lbs.	32



# POLY TOPS

## Poly Top Bakers Tables



### FLAT TOP Tubular Base



Length	24" WIDE	Price	30" WIDE	Price	Wt.	Cu. Ft.
4'	TSPT-244	\$1425	TSPT-304	\$1538	77 lbs.	8
5'	TSPT-245	1555	TSPT-305	1665	89 lbs.	9
6'	TSPT-246	2077	TSPT-306	2201	117 lbs.	11
7'	TSPT-247	2315	TSPT-307	2532	130 lbs.	13
8'	TSPT-248	2552	TSPT-308	2647	141 lbs.	15
9'	TSPT-249	2697	TSPT-309	2846	180 lbs.	17
10'	TSPT-2410	2917	TSPT-3010	2996	201 lbs.	19

### With Undershelf



Length	24" WIDE	Price	30" WIDE	Price	Wt.	Cu. Ft.
4'	SPT-244	\$1523	SPT-304	\$1628	89 lbs.	8
5'	SPT-245	1655	SPT-305	1764	102 lbs.	9
6'	SPT-246	2160	SPT-306	2313	125 lbs.	11
7'	SPT-247	2413	SPT-307	2623	141 lbs.	13
8'	SPT-248	2643	SPT-308	2849	168 lbs.	15
9'	SPT-249	2797	SPT-309	2945	196 lbs.	16
10'	SPT-2410	3017	SPT-3010	3095	230 lbs.	17

### 6" BACKSPLASH Tubular Base



Length	24" WIDE	Price	30" WIDE	Price	Wt.	Cu. Ft.
4'	TSPS-244	\$1420	TSPS-304	\$1523	87 lbs.	12
5'	TSPS-245	1571	TSPS-305	1679	101 lbs.	15
6'	TSPS-246	2096	TSPS-306	2239	131 lbs.	18
7'	TSPS-247	2403	TSPS-307	2602	145 lbs.	21
8'	TSPS-248	2619	TSPS-308	2815	160 lbs.	24
9'	TSPS-249	2769	TSPS-309	2955	210 lbs.	16
10'	TSPS-2410	2940	TSPS-3010	3024	235 lbs.	17

### With Undershelf



Length	24" WIDE	Price	30" WIDE	Price	Wt.	Cu. Ft.
4'	SPS-244	\$1619	SPS-304	\$1725	99 lbs.	12
5'	SPS-245	1840	SPS-305	1880	113 lbs.	15
6'	SPS-246	2385	SPS-306	2434	143 lbs.	18
7'	SPS-247	2707	SPS-307	2798	167 lbs.	21
8'	SPS-248	2928	SPS-308	2979	175 lbs.	24
9'	SPS-249	2973	SPS-309	3151	225 lbs.	25
10'	SPS-2410	3139	SPS-3010	3224	242 lbs.	28

## ACCESSORIES

<b>TA-41</b>	Replacement Poly-Vance 5/8" Cutting Board	\$89 /sq. ft.
<b>TA-63</b>	Removable Shelving (In Addition To Standard Shelf)	376 /table
<b>TA-82</b>	Scrap Chute	232 ea.
<b>SHD-2020</b>	Enclosed Drawers - See Page 60 For Details	1001 ea.



TA-84C Shown

### KNIFE RACKS

<b>TA-84A</b>	Roller Rim Type	\$349
<b>TA-84B</b>	Poly Table Type	349
<b>TA-84C</b>	Square Edge Type	349



17 Years in a Row!

# TABLE MODS

## Smart Table Modifications

### TOP MODIFICATIONS



**TA-56**  
5" NSF Partition



**TA-523**  
Drop-In Urn Trough



**CDR-5**  
Condiment Holder

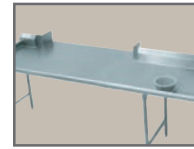

**TA-84**  
Pass-Thru



**TA-108**  
Grommet For Cords

<b>CDR-5</b>	Condiment Holder (Accommodates 5 Bins)	<b>\$784</b>
<b>TA-1</b>	Notch Backsplash For Roll Up Door w/ Pass-Thru	<b>142</b>
<b>TA-3</b>	Stainless Steel Hat Channel & Gusset Upgrade	<b>51 /lin. ft.</b>
<b>TA-7</b>	10" Partial Splash	<b>76 /lin. ft.</b>
<b>TA-8</b>	Column Notch in Rear Splash (Includes Splash)	<b>692 ea.</b>
<b>TA-10</b>	5" Partial Splash	<b>64 /lin. ft.</b>
<b>TA-12</b>	Countertop Edge	<b>636 /table</b>
<b>TA-22</b>	Square Edge Table	<b>N/C</b>
<b>TA-28</b>	Cut-Out For Cold Well. Includes Louvered Doors	<b>1471 /cut out</b>
<b>TA-29</b>	16 Ga. 304 Rear Splash Capping Strip w/Adhesive Backing	<b>63 /lin. ft.</b>
<b>TA-30</b>	1-1/2" Side Splash	<b>88 ea.</b>
<b>TA-30A</b>	1-1/2" Turn Up For Table Tops	<b>40 /lin. ft.</b>
<b>TA-31</b>	5" Side Splash	<b>165 ea.</b>
<b>TA-32</b>	10" Side Splash	<b>323 ea.</b>
<b>TA-34</b>	Top Cut-Out for Drop-In Style Units	<b>242 /cut out</b>
<b>TA-34A</b>	Top Cut-Out for Undermount Well	<b>407 /cut out</b>
<b>TA-35</b>	Splash Cut-Out	<b>176 /cut out</b>
<b>TA-41</b>	Poly-Vance 5/8" Cutting Board	<b>89 /sq. ft.</b>
<b>TA-56</b>	5" NSF Partition	<b>443</b>
<b>TA-56A</b>	18" NSF Partition	<b>638</b>
<b>TA-57</b>	Prepare Welded Field Joint (Welded in field by others)	<b>245 ea.</b>
<b>TA-57A</b>	Bolted Field Joint (Bolted in field by others)	<b>517 ea.</b>
<b>TA-57B</b>	Hairline Field Joint	<b>693 ea.</b>
<b>TA-58</b>	Stepdown to 24" Working Height	<b>1093 ea.</b>
<b>TA-64</b>	Urn Trough (Factory installation only)	<b>149 /lin. ft.</b>
<b>TA-75</b>	Mitered Edge	<b>709 ea.</b>
<b>TA-76</b>	Paint on Sound Deadening	<b>509 /table</b>
<b>TA-79</b>	Flour Trough (Factory installation only)	<b>187 /lin. ft.</b>
<b>TA-82</b>	Scrap Chute (6" dia. opening)	<b>239</b>
<b>TA-84</b>	Simple Pass-Thru	<b>628 /lin. ft.</b>
<b>TA-87</b>	Enclosed Rear Splash	<b>88 /lin. ft.</b>
<b>TA-91</b>	Poly Retaining Clips Includes TA-22 (S/S top table)	<b>439 /table</b>
<b>TA-93</b>	Wall Brackets (Includes 2. For 5" & 10 1/2" splash only)	<b>76 /table</b>

<b>TA-96A</b>	Can Opener Provision for Openers with Bolt-on Base (Customer to provide location)	<b>\$210 ea.</b>
<b>TA-96B</b>	Can Opener Surface Mount Provision with 4" S/S Tube for Openers w/o Base (Customer to provide location)	<b>529 ea.</b>
<b>TA-96C</b>	Can Opener Spacer Plate Provision for Use on Tables With Countertop Edge & Can Opener Base (Customer to provide location)	<b>326 ea.</b>
<b>TA-100</b>	Bull Nose All Sides of Worktable	<b>N/C</b>
<b>TA-101</b>	Rear Tray Lock	<b>88 /lin. ft.</b>
<b>TA-106</b>	Mirror HI-LITE Edge	<b>395 /table</b>
<b>TA-107</b>	Vacuum Breaker Holes on Tables (Includes Back-splash with 2" Return)	<b>362</b>
<b>TA-108</b>	2" Hole with Grommet for Appliance Cord	<b>130 ea.</b>
<b>TA-112</b>	Hubble Outlet	<b>563 ea.</b>
<b>TA-113</b>	Notch Top for Buyout Unit	<b>813 ea.</b>
<b>TA-366A</b>	Heavy Duty Understructure Top	<b>319 /table</b>
<b>TA-502</b>	Install Advance Tabco Drop-In Hand Sinks or Hot Food Unit In Work Table Top (Hot Food Unit Requires TA-34 Top Cut-Out & TA-27 Control Panel. Does not include wiring. Consult factory)	<b>528 ea.</b>
<b>TA-503</b>	Install Advance Tabco 7-PS-42/7-PS-43 Hand Sinks for Countertops (Includes Cut-Out)	<b>417 ea.</b>
<b>TA-521</b>	Drop-In urn Trough 1'	<b>148 ea.</b>
<b>TA-522</b>	Drop-In urn Trough 2'	<b>293 ea.</b>
<b>TA-523</b>	Drop-In urn Trough 3'	<b>441 ea.</b>
<b>TA-524</b>	Drop-In urn Trough 4'	<b>589 ea.</b>
<b>TA-525</b>	Drop-In urn Trough 5'	<b>608 ea.</b>
<b>TA-526</b>	Drop-In urn Trough 6'	<b>644 ea.</b>
<b>TA-527</b>	Drop-In urn Trough 7'	<b>682 ea.</b>
<b>TA-528</b>	Drop-In urn Trough 8'	<b>702 ea.</b>
<b>TA-529</b>	Drop-In urn Trough 9'	<b>745 ea.</b>
<b>TA-550</b>	Install Customer Supplied Buyout Items (Does not include wiring. Consult factory)	<b>Call for Price</b>
<b>TA-551</b>	Installation of Customer Supplied Hot Food Wells. (Requires TA-34 Top Cut-Out & TA-27 Control Panel. Does not include wiring. Consult factory)	<b>786 ea.</b>

# TABLE MODS

## Smart Table Modifications

Call For Installation of Buyout Equipment!

### BASE MODIFICATIONS



**TA-39**  
Louvered Hinged Doors

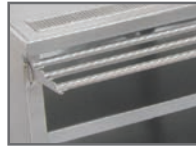

**TA-73**  
Drop-Down Tray Slide

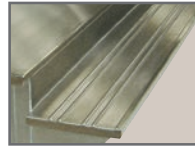

**TA-74**  
Solid Tray Slide



**TA-900**  
Adjustable Table Height

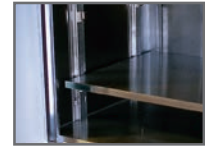

**TA-116**  
Adj. Mid-Shelf

<b>TA-4</b>	Removable Access Panel	\$178 /lin. ft.
<b>TA-4A</b>	Louvered Panel	480 /lin. ft.
<b>TA-5</b>	Curb Mounting Provision	200 ea.
<b>TA-15</b>	Provision for Built In Drawer Warmer	385 ea.
<b>TA-23</b>	Welded Set-Up Table/Crating	382 /table
<b>TA-24</b>	Shell Crating	282 /table
<b>TA-27</b>	Control Panel (Must add TA-34A)	277 /lin. ft.
<b>TA-36A</b>	Sliding/Hinge Stainless Steel Doors	441 /door
<b>TA-36B</b>	1/2 Height Stainless Steel Hinge Doors	448 set/2
<b>TA-36C</b>	Hinged door with Trash Flap	618 /ea.
<b>TA-37</b>	Stainless Enclosed Base	347 /lin. ft.
<b>TA-39</b>	24" Louvered Hinged Doors	636 /door
<b>TA-40</b>	Remove Undershef in Cabinet Base For Slide in Buyout	N/C
<b>TA-42</b>	Interior Partition (2.5"x30")	204 ea.
<b>TA-43</b>	Filler Panel (3"x30" with Flanged Feet)	434 ea.
<b>TA-44</b>	K.D. Aluminum Pan Rack Slides (6 slides. Table min. lgth. 30")	613
<b>TA-45</b>	K.D. Aluminum Glass Rack Slides (3 slides. Table min. lgth. 3 feet)	560
<b>TA-46</b>	Door Locks	283 ea.
<b>TA-48</b>	12"x12" Cut-Out in Back Panel/Undershef for Plumbing	229

<b>TA-54</b>	Removable Kick Plate	\$148 /lin. ft.
<b>TA-55</b>	Remove Back Panel (on Enclosed Base)	N/C
<b>TA-63</b>	Removable Shelving (In addition to standard shelf & table width)	376 /table.
<b>TA-70</b>	S/S Tubular Tray Divider (12" sections)	702 ea.
<b>TA-73</b>	Tubular Tray Slide w/Dropdown (Stationary Tray Slide Available. Factory installation only)	255 /lin. ft.
<b>TA-74</b>	Solid Tray Slide	350 /lin. ft.
<b>TA-92</b>	12" Apron (in front of sink)	161 /lin. ft.
<b>TA-92A</b>	17" Stainless Steel Apron to Cover Sink Bowls and Support Lever Drain Handles	242 /lin. ft.
<b>TA-116</b>	Adjustable Enclosed Base Cabinet Mid Shelf- Add to Price of Enclosed Base Table with Fixed Mid Shelf (M) on Page 45. Shelves Over 36" In Length Require Multiple Sections With Center Partition. For Partial Shelves Add To Price Of Shelf On Page 62.	762 ea.
<b>TA-130</b>	Cutlery Dispenser Holder (Undercounter Mounted)	215 /lin. ft.
<b>TA-135</b>	Plate Shelf (Undercounter Mounted)	257 /lin. ft.
<b>TA-205</b>	Connect Cafeteria Items (Per Joint Between 2 Tables. Requires Casters)	513 /set
<b>TA-900</b>	Upgrade Table To Be Height Adjustable In Field (Up to 6' Only. Unit Ships Set Up)	4431 ea.

### ELECTRICAL & DATA PORT OUTLETS



**TA-62**  
Duplex Outlet



**TA-62A**  
GFI Duplex Outlet



**TA-62D**  
GFI Doghouse Outlet



**TA-62F**  
Empty Junction Box

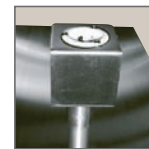

**TA-112**  
Hubble Outlet

<b>TA-62A</b>	GFI Duplex Outlet & Cover Plate in a VKS or KSS (1" Deep) Splash. NEMA 5-20R	401 ea.
<b>TA-62C</b>	GFI Duplex Outlet & Cover Plate Below Shelf Top. NEMA 5-20R	436 ea.
<b>TA-62D</b>	GFI Duplex Outlet & Cover Plate in a Doghouse. NEMA 5-20R	\$464 ea.



<b>TA-62E</b>	Upgrade Outlet to a NEMA 6-20R or Equiv.	307 ea.
<b>TA-62F</b>	Junction Box (empty) Below Table Top. Includes 1 Gang Size, Stainless Steel Face Plate	211 ea.
<b>TA-112</b>	Hubble Outlet	563 ea.
<b>TA-622</b>	CAT-5 Data Port Outlet. Cable Not Included	414 ea.

Email in your specifications to [smartfab@advancetabco.com](mailto:smartfab@advancetabco.com)

# MORE TABLE MODS

## Smart Table Modifications

### OVERSHELF & POT RACK MODIFICATIONS

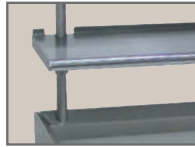

**TA-9A**  
1" Turn Up



**TA-22A**  
Square Edge



**TA-71**  
Heat Lamp Mounting Provision



**TA-100A**  
Bull Nose

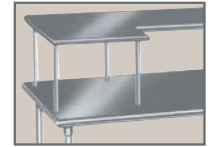

**TA-102**  
24" x 24" Extension

<b>TA-9A</b>	Partial 1" Turn-Up for all Table Mt. Shelves	<b>\$40 /lin. ft.</b>
<b>TA-22A</b>	Square Edge on Overshelf	<b>93</b>
<b>TA-26-10</b>	Welded Wall Shelf Brackets for 10" Wide Shelf	<b>232 /shelf</b>
<b>TA-26-12</b>	Welded Wall Shelf Brackets for 12" Wide Shelf	<b>232 /shelf</b>
<b>TA-26-15</b>	Welded Wall Shelf Brackets for 15" Wide Shelf	<b>232 /shelf</b>
<b>TA-26-18</b>	Welded Wall Shelf Brackets for 18" Wide Shelf	<b>232 /shelf</b>
<b>TA-47</b>	Shelf Mounting Bracket for Existing Table	<b>85 /shelf</b>
<b>TA-49</b>	Wall Shelf 2" Offset	<b>164 /shelf</b>
<b>TA-60</b>	Special Sizing Charge for Shelves (Must Order Larger Unit to be Cut Down to Smaller Size)	<b>N/C</b>
<b>TA-71</b>	Heat Lamp Mounting Provision (Heat Lamp Installed By Others)	<b>148 ea.</b>
<b>TA-71A</b>	Heat Lamp Remote Control Bracket	<b>290 ea.</b>
<b>TA-78</b>	Additional Lin. Ft. Past 12' For Table Mt. Shelf (For ODS, OTS, TS, DS & WS Shelving only)	<b>172 /lin. ft.</b>
<b>TA-77</b>	Check Minder Shelf Provision (Factory install only)	<b>53 /lin. ft.</b>
<b>TA-83</b>	Spice Bins	<b>225 ea.</b>

<b>TA-84A</b>	Knife Rack for Rolled Rim Tables	<b>\$349 ea.</b>
<b>TA-84B</b>	Knife Rack for Poly Top Tables	<b>349 ea.</b>
<b>TA-84C</b>	Knife Rack for Square Edge Tables	<b>349 ea.</b>
<b>TA-86</b>	Stainless Steel Pot Hooks	<b>24 ea.</b>
<b>TA-89</b>	Double Sided Plated Pot Hooks (Package of 4)	<b>62 /pack</b>
<b>TA-89A</b>	Single Sided Plated Pot Hooks (Package of 4)	<b>57 /pack</b>
<b>TA-98</b>	Stainless Steel Flat Bar in lieu of Chain	<b>282 ea.</b>
<b>TA-99</b>	16 Ga. S/S 304 Upgrade for Wall & Over Shelves	<b>24 /lin. ft.</b>
<b>TA-100A</b>	Bull Nose All Sides of Shelf	<b>N/C</b>
<b>TA-100R</b>	Bull Nose Three Sides of Shelf w/ Rear Turn Up	<b>112</b>
<b>TA-102</b>	24" x 24" Extension for Microwave or Computer Shelf (Add to OTS and ODS Shelves. See page 68)	<b>387 ea.</b>
<b>TA-103</b>	24" Wide PT Shelf (36" Min Length. Mid mt only. See Pg. 73. Add to 18" Wide Shelf)	<b>115 /lin. ft.</b>
<b>TA-104</b>	Additional Length Over 12' (Add to 18" Shelf. (PA & CU Shelving Only. Max. Length is 14' as Single Piece)	<b>249 /lin. ft.</b>

### UNDERSHELF MODIFICATIONS

<b>TA-9</b>	1-1/2" Turn-Up for Undershelves	<b>\$40 /lin. ft.</b>
<b>TA-17</b>	Upgrade Undershef to a Marine Edge (Must add TA-23)	<b>439 ea.</b>
<b>TA-48</b>	12"x12" Cut-Out in Back Panel or Undershef for Plumbing	<b>229</b>

<b>TA-94</b>	Upgrade 16 Ga. 304 S/S Undershef	<b>\$51 /lin. ft.</b>
<b>TA-94A</b>	Upgrade 14 Ga. 304 S/S Undershef	<b>65 /lin. ft.</b>
<b>TA-366</b>	Reinforced Understructure For Undershelves	<b>319 /table</b>

### SIZE MODIFICATIONS

<b>TA-33</b>	Special Working Height	<b>\$96</b>
<b>TA-59</b>	36" Wide Equipment Stand	<b>277 ea.</b>
<b>TA-6</b>	Extra Length for Standard Tables Over 12' (Tables Over 14' Require Field Joint TA-57)	<b>367 /lin. ft.</b>
<b>TA-61</b>	Special Sizing Charge (Larger Unit Cut Down to Smaller Size)	<b>N/C</b>
<b>TA-61A</b>	Special Modification Charge	<b>242</b>

<b>TA-65</b>	Enclosed Base Units Over 12' (Open Base Table)	<b>\$475 /lin. ft.</b>
<b>TA-66</b>	Enclosed Base Units Over 12' (Sliding Door Units)	<b>692 /lin. ft.</b>
<b>TA-67</b>	Enclosed Base Units Over 12' (Hinged Door Units)	<b>733 /lin. ft.</b>
<b>TA-105</b>	Modify Enclosed Base Table w/ Drawers to 24" Width	<b>291 /table</b>
<b>TA-110</b>	Modify Enclosed Base Table w/ Drawers to 36" Width	<b>55 /lin. ft.</b>

### LEG MODIFICATIONS

<b>TA-16</b>	Galvanized Leg w/ Plastic Bullet Foot (34 1/2" Total Length)	<b>\$55 ea.</b>
<b>TA-16-4</b>	Galvanized Legs w/ Plastic Bullet Feet (34 1/2" Total Length)	<b>219 set/4</b>
<b>TA-16-6</b>	Galvanized Legs w/ Plastic Bullet Feet (34 1/2" Total Length)	<b>262 set/6</b>
<b>TA-19</b>	Flanged Stainless Steel Bullet Feet (34 1/2" Total Length)	<b>53 ea.</b>
<b>TA-20</b>	Stainless Steel Leg w/ S/S Bullet Foot (34 1/2" Total Length)	<b>64 ea.</b>
<b>TA-20-4</b>	Stainless Steel Legs w/ S/S Bullet Feet (34 1/2" Total Length)	<b>257 set/4</b>

<b>TA-20-6</b>	Stainless Steel Legs w/ S/S Bullet Feet (34 1/2" Total Length)	<b>\$386 set/6</b>
<b>TA-21</b>	Stainless Steel Bullet Foot	<b>25 ea.</b>
<b>TA-68</b>	Relocate rear cross rail to center (for chairs/stools on both sides of table. For Open Base Tables Only)	<b>106 ea.</b>
<b>TA-72</b>	Leg to Wall Brace (Set per table)	<b>283 /table</b>
<b>TA-95</b>	Upgrade 16 Ga. 304 S/S Legs Only	<b>121 /table</b>



# TABLE ACCESSORIES

## Smart Table Accessories

Faucets Included Meet  
Federal Lead Free Standards



## COUNTERTOP INSTALLED HAND SINKS

- 4" Side Splashes
- K-52 Lead Free Compliant Deck Mounted Faucet
- Undermount Towel Dispenser
- 3-1/2" Basket Drain



### 7-PS-42 \$2538

Bowl Size: 10" x 14" x 5"  
Overall Size: 18-1/4" x 17-5/8"  
30 lbs. 2 cu. ft. 20 gauge

- 4" Side Splashes
- Deck Mounted Lead Free Compliant Gooseneck Spout
- Undermount Towel Dispenser
- Knee Operated Valve
- 3-1/2" Basket Drain



### 7-PS-43 \$2938

Bowl Size: 10" x 14" x 5"  
Overall Size: 18-1/4" x 17-5/8"  
36 lbs. 2 cu. ft. 20 gauge



7-PS-43 Shown in Table

For Factory Installation Add **TA-503 \$417**  
Can Be Purchased Separately For In-Field Installation

## DROP-IN HAND SINKS & WATER STATIONS

For Custom Cut-Out Add **TA-34 \$229** For Factory Installation Add **TA-502 \$528**



### DI-1-5SP \$1402

#### 6" Tapered Side Splash

Splash on Rear and Both Sides  
**10" x 14" x 5" Bowl**  
Overall: 13" x 19"  
Cut-out: 12 1/4" x 18 1/4"  
16 lbs. 2 cu. ft. 20 gauge



### DI-1-10SP \$1507

#### 6" Tapered Side Splash

Splash on Rear and Both Sides  
**10" x 14" x 10" Bowl**  
Overall: 13" x 19"  
Cut-out: 12 1/4" x 18 1/4"  
18 lbs. 2 cu. ft. 20 gauge



### DI-1-9 \$952

Removable Electro-Polished  
Stainless Steel Grill  
1 1/2" IPS Basket Drain  
Overall: 12" x 14"  
Cut-Out Size: 11 1/4" x 13 1/4"  
15 lbs. 3 cu. Ft.

## Water Stations with Ice Bins

Includes K-54 8-1/4" Filler Faucet With "Push-Back" Acrylic Lever Arm (Excludes D-24-SIBL)



Acrylic  
Lever Arm



Ice Bin Inside Dim.:  
8" x 13 1/2" x 10 13/16"  
Ice Capacity: 23 lbs.

### D-24-WSIBL \$1303

Removable Grate Covers Drip Pan  
13" Deep Insulated Ice Bin w/ S/S Steel Cover  
1" IPS Drain  
Outside Dim. 21" x 18"  
Cut-Out Size: 20 5/8" x 15 1/4"  
30 lbs. 5 cu. Ft.



Acrylic  
Lever Arm



Ice Bin Inside Dim.:  
13 1/2" x 18 3/4" x 10 13/16"  
Ice Capacity: 50 lbs.

### D-24-WSIBL2 \$1565

Removable Grate Covers Drip Pan  
13" Deep Insulated Ice Bin w/ S/S Steel Cover  
1" IPS Drain  
Outside Dim.: 18" x 21"  
Cut-Out Size: 15 1/4" x 20 5/8"  
47 lbs. 5 cu. Ft.

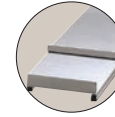

Includes Sliding  
Stainless Steel Cover



### D-24-SIBL \$1396

K-51 Deck Mounted Faucet  
Insulated Ice Bin w/ S/S Cover  
1" IPS Drain In Ice Bin  
Outside Dim.: 21" x 18"  
Cut-Out Size: 20 5/8" x 15 1/4"  
Factory Installed Only  
20 Gauge Galvanized Steel  
30 lbs. 5 cu. Ft.

Hand Sink Size:  
9 1/2" x 11 1/2" x 6"

Ice Bin Inside Dim.:  
8" x 13 1/2" x 10 13/16"

Ice Capacity: 23 lbs.

Upgrade to a 12" Filler Faucet

Use K-54OMIT, Deduct -\$385 and Add K-54A \$549

(K-54OMIT MUST be ordered with K-54A to receive upgrade)



# INTEGRAL SINKS

Integral Sinks

## WELDED SINKS INTO TABLE TOP

Includes Lead Free Compliant Faucet & K-6 Basket Drain(s)



Flat Top, 1", 1-1/2" & 5 Backsplash Include Deck Mount Faucet

- Single Sink Bowl provided with K-50 Swing Spout Faucet
- Double Sink Bowls provided with K-53 Swing Spout Faucet

10" Backsplash Include Splash Mount Faucet

- Single & Double Sink Bowls provided with K-1 Swing Spout Faucet
- Splash Mount Faucet Available On 5" Backsplash - Add TA-11Z \$40/lin. ft.



Flat Top  
w/ K-50  
Deck Mount  
Faucet Shown



10" Backsplash  
w/ K-1  
Splash Mount  
Faucet Shown

Size		Single Bowl		Double Bowl	
A	B	Model#	Price	Model#	Price
10"	14" x 5"	TA-11Q	\$1036	TA-11Q-2†	\$1893
10"	14" x 10"	TA-11F	1115	TA-11F-2†	2133
14"	16" x 12"	TA-11J	1173	TA-11J-2	2195
16"	20" x 8"	TA-11A**	1167	TA-11A-2**	2169
16"	20" x 12"	TA-11B**	1304	TA-11B-2**	2393
16"	20" x 14"	TA-11V**	1515	TA-11V-2**	2570
18"	18" x 14"	TA-11N	1329	TA-11N-2	2397
18"	24" x 14"	TA-11L	1345	TA-11L-2	2417
20"	20" x 8"	TA-11C*	1230	TA-11C-2*	2380
20"	20" x 12"	TA-11D*	1400	TA-11D-2*	2519
20"	20" x 14"	TA-11W*	1635	TA-11W-2*	2690
20"	24" x 14"	TA-11P	1428	TA-11P-2	2564
20"	30" x 14"	TA-11S*	1557	TA-11S-2*	2903
24"	24" x 14"	TA-11E*	1468	TA-11E-2*	2758
24"	30" x 14"	TA-11T*	1603	TA-11T-2*	3054
24"	36" x 14"	TA-11R*	1655	TA-11R-2*	3100

\* Only Installed In Tables 30" Wide or Wider

\*\* Bowls Are Turned with 16" Front to Back on 24" Wide Tables

† K-50 Swing Spout Faucet (Double Bowl)

### FLAT TOP, 1" or 1-1/2" REAR SPLASH

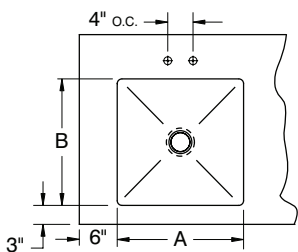

### 5" REAR SPLASH with 1" RETURN

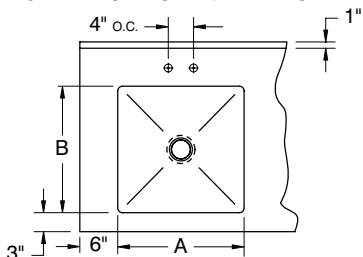

### 10" REAR SPLASH with 2" RETURN

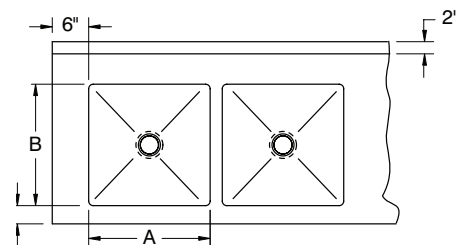

## Modifications



TA-56 \$443  
5" NSF Partition



TA-92 \$161  
Add 12" Apron  
In Front Of Sink



TA-11Z \$40/lin. ft.  
(Return Only)  
Modify 5" Splash To  
Have 2" Return For  
Splash Mounted Faucet

## Faucets & Accessories

K-2B	Poly-Vance Sink Cutting Board for 14" x 16" Bowls	\$268 ea.
K-2C	Poly-Vance Sink Cutting Board for 16" x 20" Bowls	268 ea.
K-2D	Poly-Vance Sink Cutting Board for 18" x 24" Bowls	268 ea.
K-2E	Poly-Vance Sink Cutting Board for 20" x 20" Bowls	268 ea.
K-2F	Poly-Vance Sink Cutting Board for 24" x 24" Bowls	268 ea.
K-2J	Poly-Vance Sink Cutting Board for 18" x 18" Bowls	268 ea.
K-4	Lever Drain Bracket	116
K-5	Lever Drain	252
K-12	Deck Mounted Soap Dispenser	137
K-15	Lever Drain With Overflow	447
K-50	8" Deck Mounted 4" O.C. Swing Spout Faucet	233
K-50OMIT	Omit Swing Spout	-23
K-52	3 1/2" Spout Deck Mounted 4" O.C. Gooseneck Faucet	210
K-52OMIT	Omit Swing Spout Gooseneck Faucet	-23
K-53	12" Deck Mounted 4" O.C. Swing Spout Faucet	407
K-54	8-1/4" Water Filler Faucet	446

K-54A	12" Water Filler Faucet	\$549
K-55	8 1/2" Spout 4" O.C. Deck Mounted Gooseneck Faucet	407
K-60	4" O.C. Splash Mounted Gooseneck Faucet	528
K-62	X.H.D. 4" O.C. Deck Mounted Gooseneck Faucet	418
K-105	14" Splash Mounted 8" O.C. Faucet	395
K-112	Extra Heavy Duty 12" Splash Mounted Faucets	387
K-316-LU	Wrist Handles For Splash Mounted Faucets	109
K-350	Residential Finish & Packaging	343
K-452	6" x 9" Control Bracket	254
K-453	14" x 16" Control Bracket	273
K-460	Installation Of Disposal Cone w/ 6" x 9" Control Bracket	760
K-461	Installation Of Collar w/ 6" x 9" Control Bracket	760
K-470	14" Deep Bowls	165
K-472	Faucet Hole Revision	115
DTA-100	Prerinse Basket for 20" x 20" Bowls	588
DTA-125	Prerinse Basket for 16" x 20" Bowls	512

# DRAWERS

## Integral Drawer Slides

# REVOLUTIONARY NEW SHD SERIES DRAWER WITH INTEGRAL DRAWER SLIDES



**PATENT PENDING**

- Stainless Steel Front & Sides
- Self Closing Drawer with Noise Control
- Drawer "Safety Stop" Tab
- Removable Stainless Steel Insert
- Units Can Be Stacked to Create Multiple Tier Drawers
- Hardware Included
- NSF Approved

Shown With 3 Tier Drawer Set Up

**Drawers Stack With Ease To Create Tier Drawers! Easily Installs In Field**

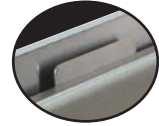

Features a "Safety Stop" Tab

**NSF**

**Insert Size**

**SHD-2015** 20" x 15" x 5" \$937 Overall Dim. 24 5/8" x 17 1/2"

**SHD-1520** 15" x 20" x 5" \$937 Overall Dim. 17 1/2" x 24 5/8"

**SHD-2020** 20" x 20" x 5" \$1001 Overall Dim. 24 5/8" x 22 11/16"

### Optional Concealed Side Panels FOR 20"x20" DRAWERS (1 Needed For Each Side)



**1 Drawer:**  
TA-SHD-1 \$146

**2 Drawers:**  
TA-SHD-2 \$183 each side

**3 Drawers:**  
TA-SHD-3 \$219

### SHD Series Modifications & Accessories

<b>TA-2</b>	Concealed Side Panel For 20" x 15" Drawer .....	\$37 ea.
	(Add Additional Cost to TA-SHD-1, 2, or 3 Price)	
<b>TA-13</b>	Padlockable Drawer Lock .....	247
<b>TA-14SHD</b>	Drawer Lock For SHD Drawers .....	136
<b>TA-97SHD</b>	Poly Board Storage Brackets For SHD Drawers .....	286
<b>TA-41SHD</b>	5/8" Thick Poly Cutting Board For SHD Drawers .....	139 ea.



**TA-97SHD \$286**  
Poly Board Storage Bracket  
(Installs In Field. Hardware Included)



Rear View of Multiple Stacked Drawers  
Drawer Seams Exposed

### DELUXE SERIES DRAWERS

- Stainless Steel Front
- Ball Bearing Slides
- Removable Insert

Insert Size	All Stainless Steel		All Stainless Steel with Keyed Lock		Galvanized Body	
	Model #	Price	Model #	Price	Model #	Price
20" x 15" x 5"	SS-2015	\$513	SS-2015-DL	\$635	GZ-2015	\$365
15" x 20" x 5"	SS-1520	513	SS-1520-DL	635	GZ-1520	365
20" x 20" x 5"	SS-2020	556	SS-2020-DL	678	GZ-2020	398



### BUDGET SERIES DRAWERS

- Friction Slides
- Die Formed Handle

Insert Size	All Stainless Steel		Galvanized Body	
	Model #	Price	Model #	Price
20" x 15" x 5"	FS-2015	\$226	FG-2015	\$151
15" x 20" x 5"	FS-1520	226	FG-1520	151
20" x 20" x 5"	FS-2020	258	FG-2020	166



### Deluxe and Budget Drawer Accessories

**Padlockable Drawer Lock** ..... **TA-13** \$247  
(Does not include lock. Fits padlocks up to 3/8" Dia. lock shaft)

**Keyed Drawer Lock** ..... **TA-14** 122  
(GZ Series)

**Drawer Adapter/Non Catalog Tables**  
(specify table width)..... **TA-90** 59

**Replacement Drawer Slides**  
(FS & FG Series) ..... **TA-SL-15** 130

**Replacement Drawer Slides**  
(SS & GZ Series) ..... **TA-SL-20** 142



TA-14 Drawer Lock

**All Units on this Page Feature  
the All New SHD Series Drawers!**

# DRAWERS

Integral Drawer Slides

## MOBILE DRAWER CABINETS

- Stainless Steel Top Features Countertop Edge
- 5" Swivel Plate Casters (2 with Brakes)
- Available with Three or Four Tier Drawers

Model #	Overall Size L x W x H	# Of Drawers	Drawer Size	Price
<b>MDC-2020</b>	25 1/4" x 25 3/4" x 29 1/2"	3	20" x 20" x 5"	<b>\$3862</b>
<b>MDC-4-2020</b>	25 1/4" x 25 3/4" x 29 1/2"	4	20" x 20" x 5"	<b>4705</b>
<b>MDC-2015</b>	25 1/4" x 21 3/4" x 29 1/2"	3	20" x 15" x 5"	<b>3736</b>
<b>MDC-4-2015</b>	25 1/4" x 21 3/4" x 29 1/2"	4	20" x 15" x 5"	<b>4559</b>



## FACTORY INSTALLED "SHD SERIES" TIER DRAWERS

**3 or 4 Tiers Available  
Factory Installation Only**

Model #	# Of Tiers	Inset Size	Price
<b>TA-38</b>	3 Tiers	20" x 20" x 5"	<b>\$3529</b>
<b>TA-384</b>	4 Tiers	20" x 20" x 5"	<b>4265</b>



TA-38 SHOWN

For Tier Drawers on 24" Tables,  
Add **TA-380 \$146** (Drawers will be 20" x 15" x 5")

**New 4 Tier Unit Offers More Storage,  
Same Height as 3 Tier Units!**

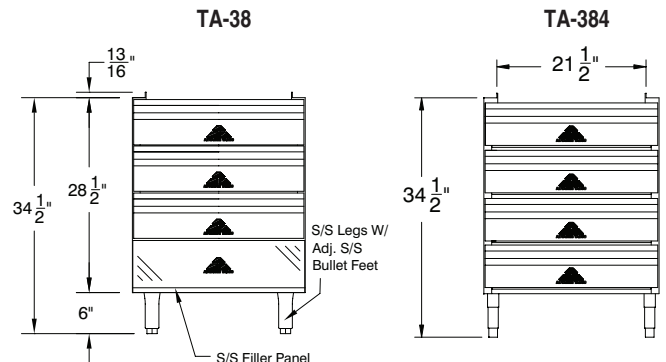

ADT-3-2020 SERIES SHOWN  
(Table Not Included)



## ADD-A-TIER DRAWERS

**Fits Under 24", 30" and 36" Wide  
Open Base Work Tables!**

**Features:**

- Units Come Fully Assembled!
- Includes 2 or 3 **SHD-2020 Series Drawers** Stacked with 2 **TA-SHD Series Concealed Side Panels** (See Photos).
- Hangs From Underside of Open Base Table with Included Hardware.

(See Page 60 for SHD Series Drawer Details)

**Includes 2 Concealed Side Panels**



2 Drawer Concealed Panel  
Model ADT-2-2020 Shown



3 Drawer Concealed Panel  
Model ADT-3-2020 Shown



Rear View of Stacked Drawers  
Drawer Seams Exposed

Model #	Overall Size L x W x H	# Of Drawers	Drawer Size	Price
<b>ADT-2-2020</b>	23" x 23" x 14"	2	20" x 20" x 5"	<b>\$2351</b>
<b>ADT-3-2020</b>	23" x 23" x 21"	3	20" x 20" x 5"	<b>3412</b>
<b>ADT-3-2015</b>	23" x 18" x 21"	3	20" x 15" x 5"	<b>3225</b>



# CASTERS

Casters

All Casters Ship Via UPS

## WORK TABLE CASTERS



### Standard Casters

Legs Cut To Maintains Standard 35-1/2" Working Height  
200 lbs. Load Capacity Per Caster

#### When Used w/ Stainless Steel Legs

TA-25S-4 \$375/set of 4 (Two with Brakes)  
TA-25S-6 \$562/set of 6 (Two with Brakes)

#### When Used w/ Galvanized Legs

TA-25G-4 \$375/set of 4 (Two with Brakes)  
TA-25G-6 \$562/set of 6 (Two with Brakes)

### Casters For Special Height Tables (TA-33) and Open Base Tables (T Series)

TA-25 \$375/set of 4 (Two with Brakes)  
TA-25A \$562/set of 6 (Two with Brakes)

200 lbs. Load Capacity Per Caster



### Single Replacement Casters

Available With Or Without Brake (Legs Not Included)

200 lbs. Load Capacity Per Caster

TA-25R \$74 ea. (No Brake) TA-25RB \$90 ea. (With Brake)



#### Optional Standard Caster Upgrades:

TA-25B \$184/set For brakes on all wheels (Standard Casters) - Add price to the following models: TA-25, TA-25A, TA-25S-4, TA-25S-6, TA-25G-4, TA-25G-6  
TA-25C \$32/Per Caster Upgrade Standard Caster with Heavy Duty Urethane Wheels (Per Caster)

## EQUIPMENT STAND CASTERS



### Standard Casters

5" Urethane Wheels.  
Maintains the Standard 24" Working Height  
200 lbs. Load Capacity Per Caster

#### w/ Stainless Steel Legs

TA-25ES \$375/set of 4 (Two with Brakes)

#### w/ Galvanized Legs

TA-25EG \$375/set of 4 (Two with Brakes)

### HEAVY DUTY Casters

5" Urethane Wheels

400 lbs. Load Capacity Per Caster

TA-255 \$513 Super Heavy Duty Set of 4 (Two with Brakes)  
TA-256 680 Super Heavy Duty Set of 6 (Two with Brakes)



### Enclosed Base Table Casters Easy Bolt-On Style



TA-255P \$606 Set of 4 (Two with Brakes)  
TA-255AP \$884 Set of 6 (Two with Brakes)  
300 lbs. Load Capacity Per Caster

For brakes on all wheels (Enclosed Base Casters) - Add price to models: TA-255P or TA-255AP

TA-255PB \$290

#### Optional Equipment Stand Caster Upgrade:

TA-255B \$251 For brakes on all wheels (Equipment Casters) - Add price to any of the following models: TA-255, TA-256, TA-25ES, TA-25EG

## MID-SHELF & UNDERSHELVES



Shelf Capacity  
20 lbs./sq. ft.



### Stainless Steel

### Galvanized

Length	Stainless Steel			Galvanized								
	24" Wide	Price	30" Wide	Price	36" Wide	Price						
2'	US-24-24	\$307	US-30-24	\$348	NOT AVAILABLE	UG-24-24	\$175	UG-30-24	\$208	NOT AVAILABLE		
30"	US-24-30	348	US-30-30	383	US-36-30	\$440	UG-24-30	208	UG-30-30	212	UG-36-30	\$217
3'	US-24-36	362	US-30-36	440	US-36-36	529	UG-24-36	219	UG-30-36	217	UG-36-36	223
4'	US-24-48	409	US-30-48	496	US-36-48	564	UG-24-48	225	UG-30-48	231	UG-36-48	233
5'	US-24-60	471	US-30-60	537	US-36-60	636	UG-24-60	231	UG-30-60	239	UG-36-60	252
6'	US-24-72	532	US-30-72	610	US-36-72	750	UG-24-72	233	UG-30-72	252	UG-36-72	257
7'	US-24-84	605	US-30-84	656	US-36-84	792	UG-24-84	239	UG-30-84	257	UG-36-84	268
8'	US-24-96	656	US-30-96	748	US-36-96	864	UG-24-96	252	UG-30-96	262	UG-36-96	290
9'	US-24-108	683	US-30-108	856	US-36-108	1030	UG-24-108	262	UG-30-108	301	UG-36-108	312
10'	US-24-120	718	US-30-120	891	US-36-120	1066	UG-24-120	284	UG-30-120	321	UG-36-120	331
11'	US-24-132	894	US-30-132	1053	US-36-132	1175	UG-24-132	315	UG-30-132	346	UG-36-132	356
12'	US-24-144	920	US-30-144	1088	US-36-144	1240	UG-24-144	353	UG-30-144	385	UG-36-144	395

TA-94 \$51 lin. ft.  
16 ga. S/S 304 Series Upgrade for any shelf

TA-9 \$40 lin. ft.  
1-1/2" Turn-Up for Undershelves

**PATENT PENDING**

## MULTI-USE FOOD SHIELDS

Quickly Converts From Cafeteria Style To Self-Serve Style



### With Stainless Steel Shelf

18" Standard Shelf Height (Top of Table to Top of Shelf). 24" Wide Shelving Also Available



DSG-12S-48 Glass Positioned For Self-Serve Style

DSG-12S-48 Glass Positioned For Cafeteria Style

- Bottom front glass locks in place at 3 fixed positions
- Entire glass front rotates for easy cleaning
- Stainless Steel 1" diameter Posts.
- Includes Two 18" Wide Glass Side Panels
- 1/4" Thick Heat-Tempered Glass Side Panels
- 3/8" Thick Heat-Tempered Glass Fronts
- Stainless Steel Top Shelf (DSG "S" Series)
- 3/8" Glass Top Shelf (DSG "G" Series)

\*Requires a Single Pair of Center Legs (Factory Print Included)  
 \*\*Requires Two Pair of Center Legs (Factory Print Included)

12" WIDE	Price	Approx. Wt.	15" WIDE	Price	Approx. Wt.	18" WIDE	Price	Approx. Wt.	Approx. Cubes
DSG-12S-36	\$4159	131 lbs.	DSG-15S-36	\$4663	133 lbs.	DSG-18S-36	\$4863	136 lbs.	14
DSG-12S-48	4302	166 lbs.	DSG-15S-48	4769	169 lbs.	DSG-18S-48	4967	173 lbs.	18
DSG-12S-60	4893	191 lbs.	DSG-15S-60	5123	196 lbs.	DSG-18S-60	5322	199 lbs.	22
DSG-12S-72	5088	237 lbs.	DSG-15S-72	5383	245 lbs.	DSG-18S-72	5706	250 lbs.	26
DSG-12S-84†	5265	276 lbs.	DSG-15S-84†	5626	279 lbs.	DSG-18S-84†	5827	286 lbs.	30
DSG-12S-96†	5718	312 lbs.	DSG-15S-96†	6016	314 lbs.	DSG-18S-96†	6214	323 lbs.	34
DSG-12S-108†	5883	346 lbs.	DSG-15S-108†	6334	353 lbs.	DSG-18S-108†	6534	359 lbs.	38
DSG-12S-120†	6053	382 lbs.	DSG-15S-120†	6528	389 lbs.	DSG-18S-120†	6714	397 lbs.	42
DSG-12S-132†	6204	420 lbs.	DSG-15S-132†	6675	428 lbs.	DSG-18S-132†	6875	437 lbs.	46
DSG-12S-144**	6493	455 lbs.	DSG-15S-144**	6803	465 lbs.	DSG-18S-144**	7002	473 lbs.	50



Bottom Glass Flips All The Way Up To Become A Self-Serve Unit

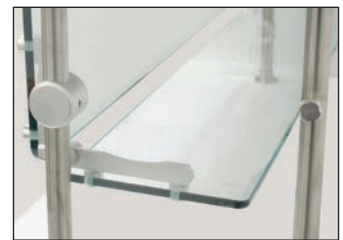

Bottom Glass Can be Used As a Shelf



Easy To Use Mechanism For Changing Front Glass Positions



Entire Glass Shield Rotates For Easy Cleaning

### With 3/8" Glass Top

18" Standard Shelf Height (Top of Table to Top of Glass Shelf)



DSG-12G-72 Glass Positioned For Self-Serve Style

DSG-12G-72 Glass Positioned For Cafeteria Style

12" WIDE	Price	Approx. Wt.	15" WIDE	Price	Approx. Wt.	18" WIDE	Price	Approx. Wt.	Approx. Cubes
DSG-12G-36	\$4958	139 lbs.	DSG-15G-36	\$5502	143 lbs.	DSG-18G-36	\$5901	147 lbs.	18
DSG-12G-48	5100	179 lbs.	DSG-15G-48	5606	182 lbs.	DSG-18G-48	6006	187 lbs.	23
DSG-12G-60	5691	228 lbs.	DSG-15G-60	5961	235 lbs.	DSG-18G-60	6351	242 lbs.	29
DSG-12G-72	5888	279 lbs.	DSG-15G-72	6222	266 lbs.	DSG-18G-72	6623	275 lbs.	34
DSG-12G-84†	6067	298 lbs.	DSG-15G-84†	6466	305 lbs.	DSG-18G-84†	6864	316 lbs.	39
DSG-12G-96†	6517	330 lbs.	DSG-15G-96†	6853	346 lbs.	DSG-18G-96†	7253	357 lbs.	44
DSG-12G-108†	6681	373 lbs.	DSG-15G-108†	7173	383 lbs.	DSG-18G-108†	7572	397 lbs.	49
DSG-12G-120†	6852	412 lbs.	DSG-15G-120†	7353	424 lbs.	DSG-18G-120†	7753	439 lbs.	55
DSG-12G-132†	7002	453 lbs.	DSG-15G-132†	7514	467 lbs.	DSG-18G-132†	7913	483 lbs.	60
DSG-12G-144**	7291	495 lbs.	DSG-15G-144**	7641	511 lbs.	DSG-18G-144**	8064	528 lbs.	65

# FOOD SHIELDS

## Adjustable Food Shields

### Sleek Shields™

Protected By: Patent No. US 9,010,883 B2

### With Stainless Steel Shelf

18" Standard Shelf Height (Top of Table to Top of Shelf) • 24" Wide Shelving Also Available

#### SELF SERVE STYLE

12" WIDE	Price	Approx. Wt.	15" WIDE	Price	Approx. Wt.	18" WIDE	Price	Approx. Wt.	Approx. Cubes
NSG-12-36	\$2773	120 lbs.	NSG-15-36	\$3028	122 lbs.	NSG-18-36	\$3666	124 lbs.	18
NSG-12-48	2850	152 lbs.	NSG-15-48	3157	155 lbs.	NSG-18-48	3796	159 lbs.	23
NSG-12-60*	3478	191 lbs.	NSG-15-60*	3512	194 lbs.	NSG-18-60*	4151	198 lbs.	29
NSG-12-72*	3599	221 lbs.	NSG-15-72*	3772	228 lbs.	NSG-18-72*	4411	230 lbs.	34
NSG-12-84†	3775	254 lbs.	NSG-15-84†	4015	260 lbs.	NSG-18-84†	4655	265 lbs.	39
NSG-12-96†	4227	288 lbs.	NSG-15-96†	4404	293 lbs.	NSG-18-96†	5042	299 lbs.	44
NSG-12-108**	4391	314 lbs.	NSG-15-108**	4721	321 lbs.	NSG-18-108**	5361	327 lbs.	49
NSG-12-120**	4562	363 lbs.	NSG-15-120**	4903	370 lbs.	NSG-18-120**	5541	376 lbs.	55
NSG-12-132**	4713	398 lbs.	NSG-15-132**	5064	406 lbs.	NSG-18-132**	5704	413 lbs.	60
NSG-12-144††	5002	422 lbs.	NSG-15-144††	5192	430 lbs.	NSG-18-144††	5832	439 lbs.	65

- †Requires a Single Pair of Center Legs (Factory Print Included)
- ††Requires Two Pair of Center Legs (Factory Print Included)
- \*3/8" Thick Heat-Tempered Glass Required For Front Glass

#### Exclusive Features Of NSG/NDSG/NSGC Sleek Shields:

- Front glass locks in place at 15° intervals
- Stainless Steel 1" diameter Posts
- Includes Two 1/4" Heat-Tempered Side Glass
- 1/4" or 3/8" Thick Heat-Tempered Glass Front Panels (See Chart For "\*\*" Symbol)
- Shelves have two rolled edges on front & rear and square edges on left & right sides

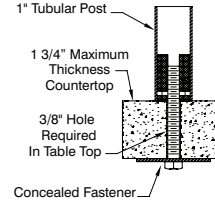

Includes Standard Concealed Mounting Hardware  
(Access To Underside Of Counter Required)

Sleek Shields™ w/ Stainless Steel or Glass Shelf Can Be Added To All Hot/Cold Food Tables On Pages 117-125  
See Models On Page 130



Shipped KD - TA-47 Mounting Brackets Included For In-Field Installation

#### SELF SERVE STYLE - DOUBLE TIER

12" WIDE	Price	Approx. Wt.	15" WIDE	Price	Approx. Wt.	18" WIDE	Price	Approx. Wt.	Approx. Cubes
NDSG-12-36	\$4379	155 lbs.	NDSG-15-36	\$4571	160 lbs.	NDSG-18-36	\$5211	166 lbs.	26
NDSG-12-48	4568	194 lbs.	NDSG-15-48	4701	199 lbs.	NDSG-18-48	5339	206 lbs.	34
NDSG-12-60*	5159	243 lbs.	NDSG-15-60*	5056	250 lbs.	NDSG-18-60*	5697	258 lbs.	41
NDSG-12-72*	5354	277 lbs.	NDSG-15-72*	5316	290 lbs.	NDSG-18-72*	5957	308 lbs.	49
NDSG-12-84†	5533	324 lbs.	NDSG-15-84†	5559	330 lbs.	NDSG-18-84†	6198	344 lbs.	56
NDSG-12-96†	5985	353 lbs.	NDSG-15-96†	5948	365 lbs.	NDSG-18-96†	6588	376 lbs.	64
NDSG-12-108**	6149	399 lbs.	NDSG-15-108**	6266	405 lbs.	NDSG-18-108**	6904	411 lbs.	71
NDSG-12-120**	6321	443 lbs.	NDSG-15-120**	6449	445 lbs.	NDSG-18-120**	7087	457 lbs.	79
NDSG-12-132**	6470	483 lbs.	NDSG-15-132**	6608	496 lbs.	NDSG-18-132**	7248	503 lbs.	86
NDSG-12-144††	6553	513 lbs.	NDSG-15-144††	6736	546 lbs.	NDSG-18-144††	7462	546 lbs.	94



10-1/2" Standard Glass Opening (Maximum 13")  
From Table To Bottom Of Glass.

#### CAFETERIA STYLE

12" WIDE	Price	Approx. Wt.	15" WIDE	Price	Approx. Wt.	18" WIDE	Price	Approx. Wt.	Approx. Wt.
NSGC-12-36	\$3094	125 lbs.	NSGC-15-36	\$3598	128 lbs.	NSGC-18-36	\$3798	130 lbs.	18
NSGC-12-48	3237	160 lbs.	NSGC-15-48	3704	163 lbs.	NSGC-18-48	3902	167 lbs.	23
NSGC-12-60*	3828	185 lbs.	NSGC-15-60*	4058	190 lbs.	NSGC-18-60*	4257	193 lbs.	29
NSGC-12-72*	4023	231 lbs.	NSGC-15-72*	4318	239 lbs.	NSGC-18-72*	4641	244 lbs.	34
NSGC-12-84†	4200	270 lbs.	NSGC-15-84†	4561	274 lbs.	NSGC-18-84†	4762	281 lbs.	39
NSGC-12-96†	4653	306 lbs.	NSGC-15-96†	4951	308 lbs.	NSGC-18-96†	5149	317 lbs.	44
NSGC-12-108**	4818	340 lbs.	NSGC-15-108**	5269	347 lbs.	NSGC-18-108**	5469	353 lbs.	49
NSGC-12-120**	4988	376 lbs.	NSGC-15-120**	5463	383 lbs.	NSGC-18-120**	5649	391 lbs.	55
NSGC-12-132**	5139	414 lbs.	NSGC-15-132**	5610	422 lbs.	NSGC-18-132**	5810	431 lbs.	60
NSGC-12-144††	5428	450 lbs.	NSGC-15-144††	5738	574 lbs.	NSGC-18-144††	5937	467 lbs.	65



1-1/2" Standard Glass Opening (Maximum 1-1/2")  
From Table To Bottom Of Glass.

**CUSTOM UNITS & SIZES AVAILABLE ON ALL FOOD SHIELDS**

Food Shield Prices May Change Due To Customer Specifications & Design



### With Glass Top

3/8" Thick Heat-Tempered Glass Top

†Requires a Single Pair of Center Legs (Factory Print Included)  
 ††Requires Two Pair of Center Legs (Factory Print Included)  
 \*3/8" Thick Heat-Tempered Glass Required For Front Glass

#### Exclusive Features Of GSG/GSGC/NSGD Sleek Shields:

- Front glass locks in place at 15° intervals
- Stainless Steel 1" diameter Posts
- Includes Two 1/4" Heat-Tempered Side Glass
- 1/4" or 3/8" Thick Heat-Tempered Glass Front Panels (See Chart For "\*" Symbol)
- Glass Top Features 3/8" Heat-Tempered Glass Top

### SELF SERVE STYLE

12" WIDE	Price	Approx. Wt.	15" WIDE	Price	Approx. Wt.	18" WIDE	Price	Approx. Wt.	Approx. Cubes
GSG-12-36	\$3116	127 lbs.	GSG-15-36	\$3559	130 lbs.	GSG-18-36	\$3959	133 lbs.	18
GSG-12-48	3250	162 lbs.	GSG-15-48	3689	167 lbs.	GSG-18-48	4089	173 lbs.	23
GSG-12-60*	3851	202 lbs.	GSG-15-60*	4045	209 lbs.	GSG-18-60*	4444	216 lbs.	29
GSG-12-72†	3970	238 lbs.	GSG-15-72†	4305	245 lbs.	GSG-18-72†	4705	253 lbs.	34
GSG-12-84†	4148	274 lbs.	GSG-15-84†	4549	282 lbs.	GSG-18-84†	4948	292 lbs.	39
GSG-12-96†	4601	309 lbs.	GSG-15-96†	4935	319 lbs.	GSG-18-96†	5336	330 lbs.	44
GSG-12-108*†	4763	338 lbs.	GSG-15-108*†	5255	350 lbs.	GSG-18-108*†	5640	362 lbs.	49
GSG-12-120*†	4934	391 lbs.	GSG-15-120*†	5435	403 lbs.	GSG-18-120*†	5834	417 lbs.	55
GSG-12-132*†	5086	427 lbs.	GSG-15-132*†	5613	442 lbs.	GSG-18-132*†	5997	457 lbs.	60
GSG-12-144††	5375	455 lbs.	GSG-15-144††	5725	472 lbs.	GSG-18-144††	6125	489 lbs.	65



10-1/2" Standard Glass Opening (Maximum 13")  
 From Table To Bottom Of Glass.  
 Max. Load For Top Glass Is 100 Lbs. Even Dist. Wt.

### CAFETERIA STYLE

12" WIDE	Price	Approx. Wt.	15" WIDE	Price	Approx. Wt.	18" WIDE	Price	Approx. Wt.	Approx. Cubes
GSGC-12-36	\$3467	133 lbs.	GSGC-15-36	\$4011	137 lbs.	GSGC-18-36	\$4410	141 lbs.	18
GSGC-12-48	3609	173 lbs.	GSGC-15-48	4115	176 lbs.	GSGC-18-48	4515	182 lbs.	23
GSGC-12-60*	4200	222 lbs.	GSGC-15-60*	4470	229 lbs.	GSGC-18-60*	4860	236 lbs.	29
GSGC-12-72†	4397	274 lbs.	GSGC-15-72†	4731	260 lbs.	GSGC-18-72†	5132	269 lbs.	34
GSGC-12-84†	4576	292 lbs.	GSGC-15-84†	4975	300 lbs.	GSGC-18-84†	5373	311 lbs.	39
GSGC-12-96†	5026	330 lbs.	GSGC-15-96†	5362	340 lbs.	GSGC-18-96†	5762	351 lbs.	44
GSGC-12-108*†	5190	367 lbs.	GSGC-15-108*†	5682	377 lbs.	GSGC-18-108*†	6081	391 lbs.	49
GSGC-12-120*†	5361	406 lbs.	GSGC-15-120*†	5862	419 lbs.	GSGC-18-120*†	6262	434 lbs.	55
GSGC-12-132*†	5511	447 lbs.	GSGC-15-132*†	6023	461 lbs.	GSGC-18-132*†	6422	477 lbs.	60
GSGC-12-144††	5800	489 lbs.	GSGC-15-144††	6150	505 lbs.	GSGC-18-144††	6573	522 lbs.	65

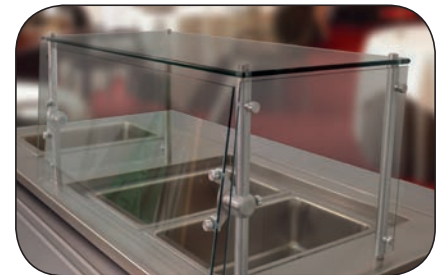

1-1/2" Standard Glass Opening (Maximum 1-1/2")  
 From Table To Bottom Of Glass.  
 Max. Load For Top Glass Is 100 Lbs. Even Dist. Wt.

### SELF SERVE STYLE - DOUBLE SIDED

w/ Stainless Steel Shelf			w/ Glass Top			
Model #	Price	Approx. Wt.	Model #	Price	Approx. Wt.	Approx. Cubes
NSGD-40-36	\$5083	339 lbs.	GSGD-40-36	\$5197	368 lbs.	32
NSGD-40-48	5219	391 lbs.	GSGD-40-48	5334	437 lbs.	42
NSGD-40-60*	5819	451 lbs.	GSGD-40-60*	5933	509 lbs.	51
NSGD-40-72†	5937	518 lbs.	GSGD-40-72†	6051	592 lbs.	61
NSGD-40-84†	6116	604 lbs.	GSGD-40-84†	6230	660 lbs.	70
NSGD-40-96†	6568	667 lbs.	GSGD-40-96†	6682	729 lbs.	79
NSGD-40-108*†	6731	725 lbs.	GSGD-40-108*†	7104	798 lbs.	89
NSGD-40-120*†	6902	782 lbs.	GSGD-40-120*†	7359	868 lbs.	98
NSGD-40-132*†	7053	840 lbs.	GSGD-40-132*†	7509	932 lbs.	107
NSGD-40-144††	7344	909 lbs.	GSGD-40-144††	7675	1001 lbs.	117



GSGD Series Shown  
 10-1/2" Standard Glass Opening (Maximum 13")  
 From Table To Bottom Of Glass.  
 Max. Load For Top Glass Is 100 Lbs. Even Dist. Wt.

**Sleek Shields™ w/ Stainless Steel or Glass Shelf Can Be Added To Hot/Cold Food Tables**  
 With 2, 3 or 4 Wells, Listed On Pages 118-127  
 See Models On Page 132  
 Shipped KD - TA-47 Mounting Brackets Included For In-Field Installation





# FOOD SHIELDS

## Adjustable & Stationary Food Shields



For Accessories & Modifications Available - See Page 67

### Sleek Shields™ SELF SERVE FOOD SHIELD

14 3/4" Standard Front Glass  
Glass Clearance is 10" From Table to Bottom of Glass

Single Front Glass				Dual Front Glass (Includes Center Post)			
Model #	Price	Approx. Wt.	Approx. Cubes	Model #	Price	Approx. Wt.	Approx. Cubes
GS-36	\$3466	136	20	GS-72	\$4360	243	37
GS-48	3577	171	26	GS-84	4503	280	40
GS-60	3687	266	31	GS-96	5318	317	44
GS-66	3834	238	34	GS-120	5570	358	48



FEATURING  
CHAMBER LOCK™  
ROTATION SYSTEM  
Protected By: Patent No. US  
9,010,883 B2

- 3/8" Thick Heat-Tempered Glass Front
- 2 - 21 7/8" Wide x 22" High, 1/4" Thick Heat-Tempered Side Glass
- 1" Stainless Steel Tubing Posts

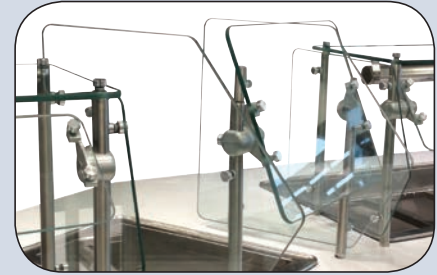

### STATIONARY FOOD SHIELDS w/ 12" WIDE GLASS TOP

Includes Front & Side Glass • 15" Wide Glass Top Also Available

- 3/8" Thick Heat-Tempered Top Glass
- 1/4" Thick Heat-Tempered Front Glass
- Two 1/4" Thick Heat-Tempered Glass Side Panels

- 1" Stainless Steel Rounded Tubing
- Includes Standard Concealed Mounting Hardware (Access To Underside Of Counter Required)

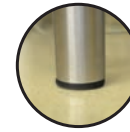

Convert Stationary Food Shields  
With Glass Top Or Angled Front  
To Be Portable STP-1 - \$504

#### Self-Serve Style

8" Standard Front Glass Height

Model #	Price	Approx. Wt.	Approx. Cubes
STFS-12-36	\$4074	144 lbs.	6
STFS-12-48	4218	184 lbs.	8
STFS-12-60*	4561	230 lbs.	9

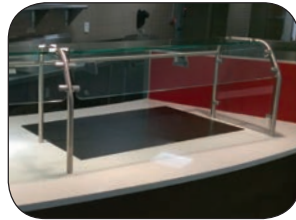

\*3/8" Thick Heat-Tempered Glass Required For Front

#### Cafeteria Style

19" Standard Front Glass Height

Model #	Price	Approx. Wt.	Approx. Cubes
STFC-12-36	\$4444	155 lbs.	6
STFC-12-48	4539	196 lbs.	8
STFC-12-60*	4906	260 lbs.	9



### 45° ANGLED FOOD SHIELDS

#### Self-Serve Style

w/ Angled Top & Side Glass

Model #	Price	Approx. Wt.	Approx. Cubes
AFS-36	\$3070	130 lbs.	6
AFS-48	3494	164 lbs.	8
AFS-60*	3833	207 lbs.	10



Shown With Black Powder Coating

- 1/4" Thick Heat-Tempered Front Glass
- 1/4" Thick Side Glass
- 1" Stainless Steel Tubing with End Caps
- Includes Standard Concealed Mounting Hardware (Access To Underside Of Counter Required)

#### Cafeteria Style

w/ Angled Top, Front & Side Glass

Model #	Price	Approx. Wt.	Approx. Cubes
AFC-36	\$3632	143 lbs.	6
AFC-48	4049	178 lbs.	8
AFC-60*	4158	235 lbs.	10



### VERTICAL FOOD SHIELDS

24" Standard Front Glass Height



- 1/4" Thick Heat-Tempered Glass
- Two 18" Wide Glass Side Panels
- 1" Stainless Steel Tubing with End Caps (1 5/8" Tubing Also Available)
- Includes Standard Concealed Mounting Hardware (Access To Underside Of Counter Required)
- NSF Requires 60" Minimum Height Above Finished Floor
- NSF Requires 6" Maximum Height From Top of Table to Bottom of Glass

Custom Food Shield Sizes Available  
Call Our Smart Fabrication™ Department At  
800-645-3166

Model #	Price	Approx. Wt.	Approx. Cubes
SGCC-36	\$4136	139 lbs.	9
SGCC-48	4569	194 lbs.	11
SGCC-60*	5149	219 lbs.	13
SGCC-72	6519	240 lbs.	15
SGCC-84	6466	271 lbs.	17
SGCC-96	6803	311 lbs.	19
SGCC-108*	7351	357 lbs.	22
SGCC-120*	8056	412 lbs.	25
SGCC-132	8563	451 lbs.	26
SGCC-144	9176	518 lbs.	27

\*3/8" Thick Heat-Tempered Glass Required For Front

For Enclosed Base Table Options See Pages 44-45

### SLEEK SHIELDS™ ACCESSORIES & MODIFICATIONS

#### LED Display Lighting

**Factory Installed**

- Aluminum Rail with Shatter-Proof Optics
- Standard Natural Aluminum Finish. Available in White or Black
- Includes Class 2 Low Voltage Power Supply-120V-277V
- High Impact Resistant Mounting Clips
- On/Off Switch Included When Mounted on Advance Tabco Equipment



**FACTORY INSTALLED ONLY**  
**Includes Installation Charge**

L	S/S Shelf Mounted		Glass Top Mounted	
	Model #	Price	Model #	Price
1'	<b>LED-S-12</b>	<b>\$355</b>	<b>LED-G-12</b>	<b>\$522</b>
2'	<b>LED-S-24</b>	<b>429</b>	<b>LED-G-24</b>	<b>595</b>
3'	<b>LED-S-36</b>	<b>494</b>	<b>LED-G-36</b>	<b>658</b>
4'	<b>LED-S-48</b>	<b>551</b>	<b>LED-G-48</b>	<b>718</b>
5'	<b>LED-S-60</b>	<b>613</b>	<b>LED-G-60</b>	<b>781</b>
6'	<b>LED-S-72</b>	<b>698</b>	<b>LED-G-72</b>	<b>865</b>

**Shelves Require 6" Clearance On Both Sides To Fit Above Led Lighting.**

**PRINT REQUIRED FOR PROPER LED LOCATION**

#### Heat Lamp Mounting Provisions

Customers To Supply Heat Lamp

**All Food Shields With Glass Tops Require Factory Installation Only**

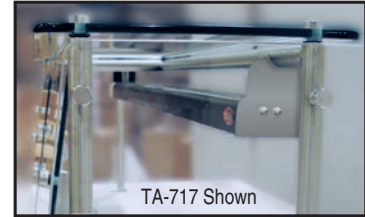

**FACTORY INSTALLED**

**TA-717 \$192 /lin. ft.**  
**MINIMUM OF 3 FEET REQUIRED. MUST ORDER SAME LENGTH AS FOOD SHIELD.**

- Welded Tubular Stainless Steel Posts
- Chase-Way for Concealing Wiring
- Pre-Wiring Available
- Print Required For Proper Installation

**INSTALLED BY OTHERS**

(Provision for mounting to Stainless Steel Shelves only)

**TA-71 \$149 ea.**

#### Revolutionary Sleek Shield™ Horizontal Swivel Bracket

- Bracket Connects Multiple Sleek Shields™ And Swivels Freely for Custom Line Up
- Easily Adjusts In Field Without Tools
- Factory Installed Only

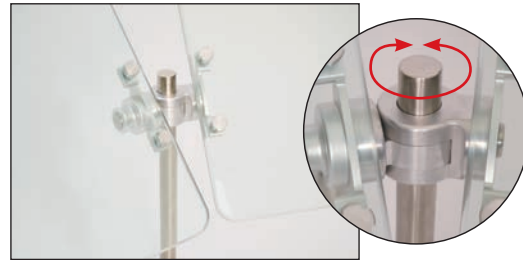

**SG-S \$1156**  
Per Section



**SG-1**

#### SURFACE MOUNTING BRACKET

(For 1" Posts)

**SG-1 \$107 ea.**

#### CANTILEVER SUPPORT BRACKET UPGRADE

(Omits Front or Rear Support Leg To Equipment in Counter)

**SG-C \$399 per leg**



**SG-PC Shown**

#### CUSTOM COLORS

**SG-AN Call For Pricing**  
Color Anodizing For Sleek Shields™ (For Aluminum Components)

**SG-PC Call For Pricing**  
Powder Coating For Sleek Shields™ (For Stainless Steel Components)

### PORTABLE FOOD SHIELDS

- 15" Front Panel
- 1/4" Thick Thermoplastic Polymer Sneeze Guard
- 1" Stainless Steel Posts
- 1-1/2" Wide x 14-1/2" Front to Back Black Support Base
- Shipped K.D.

Length	Model #	Price	Approx. Wt.	Approx. Cubes
36"	<b>PFS-36B</b>	<b>\$1803</b>	12 lbs.	14
48"	<b>PFS-48B</b>	<b>2088</b>	15 lbs.	18
60"	<b>PFS-60B</b>	<b>2348</b>	18 lbs.	21
72"	<b>PFS-72B</b>	<b>2562</b>	21 lbs.	24



PFS-36B Shown with Optional Side Panels



#### OPTIONAL 18" WIDE SIDE PANELS

18" x 20" x 1/4" Acrylic Side Panels  
Factory Installed Only

**PFS-SP \$753 /set of 2**

Approx. 5 lbs.

# SHELVING

## Stainless Steel Shelving



Shelves Mount to Underside of Table with Single Expansion Bolt to Maximize Space

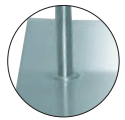

### TABLE MOUNTED ALL STAINLESS STEEL SHELVING



#### SINGLE DECK SHELVING

Ft.	12" WIDE	Price	15" WIDE†	Price	Approx. Wt.	Approx. Cubes
3'	OTS-12-36	\$687	OTS-15-36	\$822	24 lbs.	2
4'	OTS-12-48	722	OTS-15-48	890	25 lbs.	3
5'	OTS-12-60	783	OTS-15-60	1005	31 lbs.	3
6'	OTS-12-72	833	OTS-15-72	1111	37 lbs.	4
7'	OTS-12-84	890	OTS-15-84	1164	43 lbs.	5
8'	OTS-12-96*	1076	OTS-15-96*	1253	50 lbs.	5
9'	OTS-12-108*	1144	OTS-15-108*	1491	59 lbs.	6
10'	OTS-12-120*	1173	OTS-15-120*	1529	68 lbs.	7
11'	OTS-12-132*	1235	OTS-15-132*	1712	82 lbs.	7
12'	OTS-12-144*	1271	OTS-15-144*	1751	98 lbs.	8

\* SHELVES 8' OR LONGER INCLUDE CENTER LEG SUPPORT



#### DOUBLE DECK SHELVING

12" WIDE	Price	15" WIDE†	Price	Approx. Wt.	Approx. Cubes
ODS-12-36	\$1368	ODS-15-36	\$1478	24 lbs.	4
ODS-12-48	1406	ODS-15-48	1592	29 lbs.	5
ODS-12-60	1498	ODS-15-60	1787	35 lbs.	6
ODS-12-72	1598	ODS-15-72	1960	40 lbs.	7
ODS-12-84	1711	ODS-15-84	2125	46 lbs.	8
ODS-12-96*	2041	ODS-15-96*	2377	55 lbs.	10
ODS-12-108*	2198	ODS-15-108*	2587	60 lbs.	11
ODS-12-120*	2236	ODS-15-120*	2690	66 lbs.	12
ODS-12-132*	2389	ODS-15-132*	2837	72 lbs.	13
ODS-12-144*	2425	ODS-15-144*	2963	78 lbs.	14

\*8' or longer includes center leg support

For 1" Rear Turn Up, add "R" after model # (Example: OTS-12-60R) • †15" Wide Shelving has 1-5/8" Tubing

For 10" Wide Shelving – Use 12" Models & Price. Replace "12" with "10" (Example: ODS-10-36)

### TABLE MOUNTED FULLY ADJUSTABLE SHELVING WITH 14" OR 30" CHROME POSTS

#### SINGLE DECK SHELVING

Ft.	12" WIDE	Price	Approx. Wt.	Approx. Cubes
3'	TS-12-36	\$644	13 lbs.	2
4'	TS-12-48	683	15 lbs.	3
5'	TS-12-60	730	17 lbs.	3
6'	TS-12-72	780	20 lbs.	4
7'	TS-12-84	831	23 lbs.	5
8'	TS-12-96*	1015	28 lbs.	5
9'	TS-12-108*	1079	30 lbs.	6
10'	TS-12-120*	1115	33 lbs.	7
11'	TS-12-132*	1181	36 lbs.	7
12'	TS-12-144*	1219	39 lbs.	8

#### DOUBLE DECK SHELVING

Ft.	12" WIDE	Price	Approx. Wt.	Approx. Cubes
3'	DS-12-36	\$1268	24 lbs.	4
4'	DS-12-48	1306	29 lbs.	5
5'	DS-12-60	1407	35 lbs.	6
6'	DS-12-72	1507	40 lbs.	7
7'	DS-12-84	1607	46 lbs.	8
8'	DS-12-96*	1949	55 lbs.	10
9'	DS-12-108*	2112	60 lbs.	11
10'	DS-12-120*	2152	66 lbs.	12
11'	DS-12-132*	2313	72 lbs.	13
12'	DS-12-144*	2348	78 lbs.	14

\*8' or longer includes center leg support

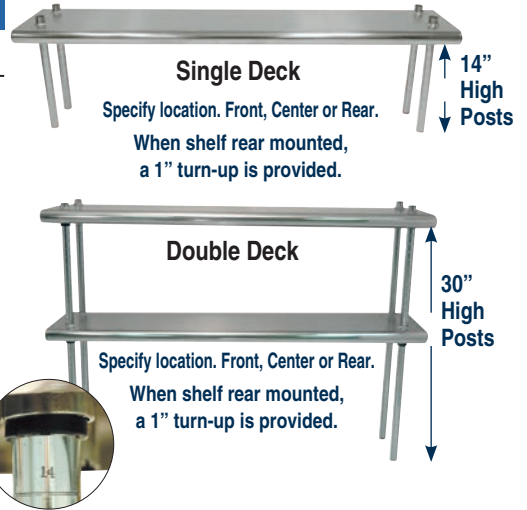

For 10" Wide Shelving Use 12" Models & Price. Replace "12" with "10" (Example: DS-10-36)

Tapered Split Sleeve Installation & Numbered Posts



For 1" Rear Turn Up, add "R" after model # (Example: TS-12-60R) • For 15" Wide Shelving (w/ 1-5/8" Tubing) Use OTS/ODS Series

### ADJUSTABLE 18" WIDE DOUBLE OVERSHELF WITH 6" OFFSET

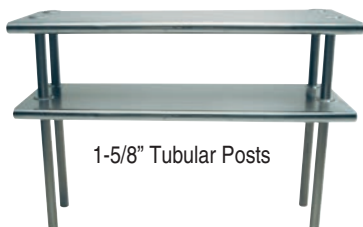

Length	Model #	Price	Approx. Wt.	Approx. Cubes
3'	CDS-18-36	\$2411	24 lbs.	4
4'	CDS-18-48	2459	29 lbs.	5
5'	CDS-18-60	2768	35 lbs.	6
6'	CDS-18-72	2827	40 lbs.	7
7'	CDS-18-84	2888	46 lbs.	8
8'	CDS-18-96	3045	55 lbs.	10
9'	CDS-18-108	3226	60 lbs.	11
10'	CDS-18-120	3276	66 lbs.	12
11'	CDS-18-132	3408	72 lbs.	13
12'	CDS-18-144	3444	78 lbs.	14



# 18" & 24" WIDE TABLE MOUNTED SHELVING



# SHELVING Specialty Shelving

## For Existing Equipment For SMART FABRICATION™ CHEF'S LINE

- Stainless Steel Shelving (1 Tier or 2 Tier Shelves)
- Stainless Steel Posts (1" Posts Available)
- Mounting Brackets Included

Customer To Specify Models Of Buyout Equipment.  
Print Required.

### Call For a Custom Quote

Quote Prints Available On Request  
- A Service Only Advance Tabco Offers!  
Call Our Estimating Department At 800-645-3166  
or email smartFab@advancetabco.com

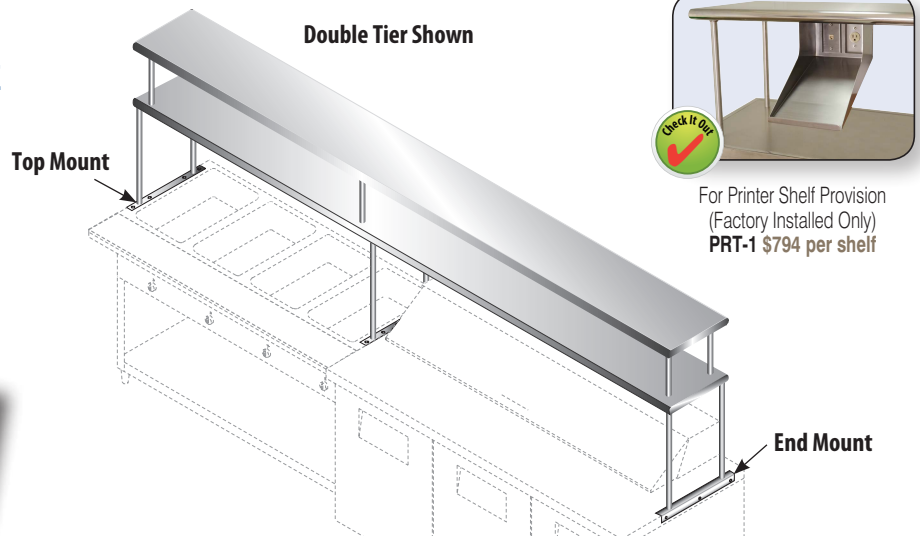

### Single Tier Shelving

Ft.	Approx. Cubes	18" WIDE	Approx. Price	Approx. Wt.	24" WIDE	Approx. Price	Approx. Wt.
4'	12	CU-18-48	\$1401	42 lbs.	CU-24-48	\$1732	55 lbs.
5'	15	CU-18-60	1447	53 lbs.	CU-24-60	1856	61 lbs.
6'	17	CU-18-72	1500	64 lbs.	CU-24-72	1937	70 lbs.
7'	20	CU-18-84	1700	75 lbs.	CU-24-84	2207	81 lbs.
8'	23	CU-18-96	1831	89 lbs.	CU-24-96	2375	98 lbs.
9'	26	CU-18-108	1975	95 lbs.	CU-24-108	2621	104 lbs.
10'	29	CU-18-120	2090	105 lbs.	CU-24-120	2822	113 lbs.
11'	32	CU-18-132	2205	118 lbs.	CU-24-132	2888	129 lbs.
12'	35	CU-18-144	2276	130 lbs.	CU-24-144	3212	146 lbs.

### Double Tier Shelving

Ft.	Approx. Cubes	18" WIDE	Approx. Price	Approx. Wt.	24" WIDE	Approx. Price	Approx. Wt.
4'	12	CU-18-48-2	\$2697	76 lbs.	CU-24-48-2	\$2968	114 lbs.
5'	15	CU-18-60-2	2826	95 lbs.	CU-24-60-2	3109	131 lbs.
6'	17	CU-18-72-2	2955	115 lbs.	CU-24-72-2	3250	152 lbs.
7'	20	CU-18-84-2	3208	135 lbs.	CU-24-84-2	3530	176 lbs.
8'	23	CU-18-96-2	3326	160 lbs.	CU-24-96-2	3659	207 lbs.
9'	26	CU-18-108-2	3473	121 lbs.	CU-24-108-2	3710	239 lbs.
10'	29	CU-18-120-2	3528	189 lbs.	CU-24-120-2	3767	283 lbs.
11'	32	CU-18-132-2	3527	212 lbs.	CU-24-132-2	3879	331 lbs.
12'	35	CU-18-144-2	3688	235 lbs.	CU-24-144-2	4058	387 lbs.

## Shelving Modifications

### Undermount Paper/Accessories Shelf

TA-117 \$250 /lin. ft.

#### Additional Fixed Partitions

(Specify Location For Factory Installation) TA-117A \$98 ea.

- 7" Wide x 12" High
- Two Adjustable Partitions To Create Separate Compartments

FACTORY INSTALLED ONLY

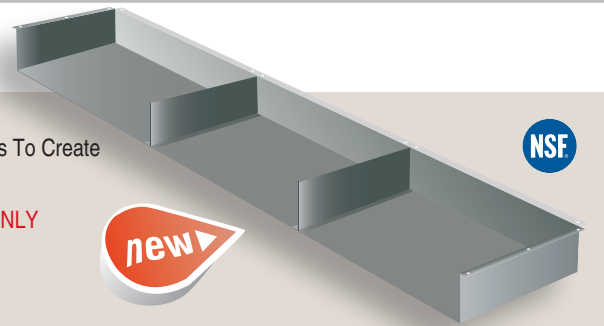

TA-9A	Partial 1" Turn-Up for all Table Mt. Shelves .....	\$40 /lin. ft.	TA-71	Heat Lamp Mounting Provision .....	\$148 ea.
TA-22A	Square Edge on Overshelf .....	93 ea.	TA-71A	Heat Lamp Remote Control Bracket.....	290 ea.
TA-26-10	Welded Wall Shelf Brackets for 10" Shelf.....	232 /shelf	TA-77	Check Minder Shelf Provision (Factory Install Only) .....	53 /lin. ft.
TA-26-12	Welded Wall Shelf Brackets for 12" Shelf.....	232 /shelf	TA-85	30" Wide CU Shelf (Add to price of 24" Shelf. For double tier, add twice) .....	188 /lin. ft.
TA-26-15	Welded Wall Shelf Brackets for 15" Shelf.....	232 /shelf	TA-99	16 Ga. S/S 304 Upgrade for Wall & Over Shelves .....	24 /lin. ft.
TA-26-18	Welded Wall Shelf Brackets for 18" Shelf.....	232 /shelf	TA-99A	14 Ga. S/S 304 Upgrade for Wall & Over Shelves .....	43 /lin. ft.
TA-33A	Customize Post Height (Specify Height) .....	46 /Shelf	TA-100A	Bull Nose Edge On all 4 Sides of Shelf .....	93 ea.
TA-47	Shelf Mounting Bracket for Existing Table .....	85 /shelf	TA-102	24" x 24" Extension for Microwave or Computer Shelf (Add to OTS and ODS Shelves. See page 45) .....	387 ea.
TA-49	Wall Shelf 2" Offset .....	164 /shelf	TA-103	24" Wide PT Shelf (36" Min Length. Mid mount only. PT Series Shelf, see pg. 48. Add to 18" Wide Shelf) .....	115 /lin. ft.
TA-60	Special Sizing Charge for Shelves (Must Order Larger Unit to be Cut Down to Smaller Size) .....	N/C	TA-104	Add'l Length Over 12' - Add to 18" or 24" Shelf (CU Shelving Only. Maximum Length is 14' as Single Piece) .....	249 /lin. ft.
TA-62	Duplex Electrical Outlet (Under Flat Top) .....	414 ea.			
TA-62D	GFI Duplex Outlet in a Doghouse Box .....	464 ea.			



# SHELVING

## Specialty Shelving

**NSF** All Pass-thru Shelving on this Page

 = Ship Via UPS

## PASS-THRU SHELVING

### Standard Pass-Thru Shelf

- "Hat Channel" Design Allows Shelf To Be Freely Positioned
- Includes Wall Mounting Brackets For Securing Shelf To Desired Position



Pass-Thru shown with Cantilever Brackets



### Pass-Thru Shelf with Overshelf

- 1 CU Series Overshelf welded to a PA Series Pass-Thru shelf
- 1-5/8" Stainless Steel Tubing
- Shipped as Welded Set-Up



Pass-Thru with CU Series Shelf & Cantilever Bracket Shown

**Pre-Wiring Available!**  
 Contact our **Smart Fab Department** at [smartfab@advancetabco.com](mailto:smartfab@advancetabco.com)

18" WIDE	Price	24" WIDE	Price	# of Length Brackets	
 PA-18-24	\$938	PA-24-24	\$1055	24"	2
 PA-18-36	1151	PA-24-36	1158	36"	2
 PA-18-48	1253	PA-24-48	1565	48"	2
PA-18-60	1349	PA-24-60	1685	60"	2
PA-18-72	1396	PA-24-72	1804	72"	2
PA-18-84	1444	PA-24-84	1973	84"	3
PA-18-96	1495	PA-24-96	2111	96"	3
PA-18-108	1558	PA-24-108	2123	108"	3
PA-18-120	1588	PA-24-120	2150	120"	3
PA-18-132	1732	PA-24-132	2348	132"	4
PA-18-144	1973	PA-24-144	2519	144"	4

18" WIDE	Price	24" WIDE	Price	# of Length Brackets	
 PA-18-48-2	\$2575	PA-24-48-2	\$3252	48"	2
 PA-18-60-2	2717	PA-24-60-2	3491	60"	2
PA-18-72-2	2813	PA-24-72-2	3689	72"	2
PA-18-84-2	3051	PA-24-84-2	4124	84"	3
PA-18-96-2	3230	PA-24-96-2	4425	96"	3
PA-18-108-2	3429	PA-24-108-2	4681	108"	3
PA-18-120-2	3570	PA-24-120-2	4911	120"	3
PA-18-132-2	3822	PA-24-132-2	5168	132"	4
PA-18-144-2	4126	PA-24-144-2	5657	144"	4

#### Mounting Brackets Included

With Pass-Thru Shelving



**\*2" x 4" - L Bracket**  
For 18" Wide Shelves



**\*\*5" x 5" - Cantilever Bracket**  
For 24" Wide Shelves

### PASS-THRU MODIFICATION

Includes Side & Top • Minimum Length = 36"

#### Pass-Thru Frame

Length	Model	Price
36"	TA-84F-36	\$1156
48"	TA-84F-48	1283
60"	TA-84F-60	1413
72"	TA-84F-72	1512
84"	TA-84F-84	1590



**Print Required For Proper Location**

## Electrical Utility Chases

**Call For Wiring Installation!**

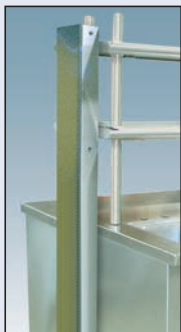

FLOOR CHASE



CEILING CHASE

- Conceals Wires
- Removable Panel For Wire Access.
- Wiring Available Upon Request.

Available only for CU Series & OTS Series Shelving (Pages 68-69)

MODEL	FEED TYPE	PRICE
UCC-1	Ceiling	\$1529
UCF-1	Floor	1350

**Print required for proper chase location.**  
Utility Chase is **FACTORY INSTALLATION** only.

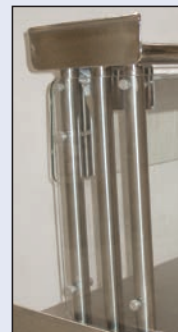

PIPE CHASE

- Conceals Wires For Heat Lamps.
- Required Installation Of Buyout Equipment

Consult Factory for Wiring

MODEL	PRICE
PC-1	\$600 ea.



Brackets Can Be Positioned To Accommodate Wall Studs



# SHELVING

## Wall Mounted Shelving

- 1 1/2" Rolled Rim With A 1 1/2" Turn-Up At Rear Ends Are Turned Down Square

### 16 GA. WALL MOUNTED SHELVING

304 Type Stainless Steel

Length	10" WIDE	Price	12" WIDE	Price	15" WIDE	Price	18" WIDE	Price	Approx. Wt.	Approx. Cubes
2'	WS-10-24-16	\$323	WS-12-24-16	\$332	WS-15-24-16	\$546	WS-18-24-16	\$757	10 lbs.	3
3'	WS-10-36-16	347	WS-12-36-16	382	WS-15-36-16	580	WS-18-36-16	791	12 lbs.	4
4'	WS-10-48-16	365	WS-12-48-16	430	WS-15-48-16	616	WS-18-48-16	827	14 lbs.	5
5'	WS-10-60-16	407	WS-12-60-16	471	WS-15-60-16	704	WS-18-60-16	915	17 lbs.	6
6'	WS-10-72-16	437	WS-12-72-16	502	WS-15-72-16	799	WS-18-72-16	1004	19 lbs.	7
7'	WS-10-84-16	500	WS-12-84-16	555	WS-15-84-16	858	WS-18-84-16	1054	22 lbs.	8
8'	WS-10-96-16	572	WS-12-96-16	608	WS-15-96-16	992	WS-18-96-16	1097	26 lbs.	10
9'	WS-10-108-16	628	WS-12-108-16	660	WS-15-108-16	1067	WS-18-108-16	1187	28 lbs.	11
10'	WS-10-120-16	709	WS-12-120-16	752	WS-15-120-16	1097	WS-18-120-16	1319	31 lbs.	12
11'	WS-10-132-16	699	WS-12-132-16	790	WS-15-132-16	1258	WS-18-132-16	1370	35 lbs.	13
12'	WS-10-144-16	754	WS-12-144-16	811	WS-15-144-16	1338	WS-18-144-16	1419	38 lbs.	14

### 18 GA. WALL MOUNTED SHELVING

430 Type Stainless Steel

Length	10" WIDE	Price	12" WIDE	Price	15" WIDE	Price	18" WIDE	Price	Approx. Wt.	Approx. Cubes
2'	WS-10-24	\$257	WS-12-24	\$266	WS-15-24	\$308	WS-18-24	\$558	10 lbs.	3
3'	WS-10-36	273	WS-12-36	304	WS-15-36	348	WS-18-36	587	12 lbs.	4
4'	WS-10-48	291	WS-12-48	343	WS-15-48	392	WS-18-48	665	14 lbs.	5
5'	WS-10-60	338	WS-12-60	376	WS-15-60	418	WS-18-60	690	17 lbs.	6
6'	WS-10-72	367	WS-12-72	403	WS-15-72	452	WS-18-72	752	19 lbs.	7
7'	WS-10-84	398	WS-12-84	444	WS-15-84	464	WS-18-84	823	22 lbs.	8
8'	WS-10-96	461	WS-12-96	486	WS-15-96	537	WS-18-96	870	26 lbs.	10
9'	WS-10-108	478	WS-12-108	529	WS-15-108	717	WS-18-108	1013	28 lbs.	11
10'	WS-10-120	570	WS-12-120	602	WS-15-120	737	WS-18-120	1054	31 lbs.	12
11'	WS-10-132	588	WS-12-132	632	WS-15-132	843	WS-18-132	1108	35 lbs.	13
12'	WS-10-144	612	WS-12-144	649	WS-15-144	891	WS-18-144	1159	38 lbs.	14

- TA-22A Square Edge Shelf \$93 ea.
- TA-26 Welded Wall Shelf Brackets 232 ea.
- TA-49 2" Wall Shelf Offset 164 /shelf
- Special Sizing Charge For Shelves N/C
- TA-60 (Must Order Larger Unit To Be Cut Down To Smaller Size) 148 ea.
- TA-71 Heat Lamp Mounting Provision 53 /lin. ft.
- TA-77 Check Minder Provision On Any Shelf 43 /lin. ft.
- TA-99A 14 Ga. S/S 304 Upgrade for Wall & Over Shelves 93 ea.
- TA-100A Bullnose Edge On All 4 Sides Of Shelf



TA-77  
Check Minder

### K.D. WALL SHELVES

Length	STAINLESS STEEL w/ Stainless Steel Brackets		ALUMINUM w/ Aluminum Brackets		Approx. Wt.	Approx. Cubes
	Model #	Price	Model #	Price		
2'	WS-KD-24	\$227	AWS-KD-24	\$186	10 lbs.	2
3'	WS-KD-36	236	AWS-KD-36	200	12 lbs.	3
4'	WS-KD-48	261	AWS-KD-48	223	14 lbs.	4
5'	WS-KD-60	294	AWS-KD-60	239	17 lbs.	5



Width Of Shelf Is 11-1/8"

Single Shipping Container Can Be Shipped U.P.S.



Custom Sizes are Available. Contact Our SMART FABRICATION™ Department. 800-645-3166

# SHELVING

## Wall Mounted Shelving



## WALL SHELVES

### Heavy Duty Slotted Cook Line Wall Shelf

- 304 Type Stainless Steel
- 21" Wide
- 1 1/2" Square Tubes
- 1 1/4" Spacing
- Tubular Support Brackets  
(Shipped Loose To Suit Wall Stud Location)

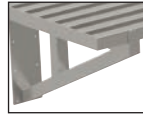
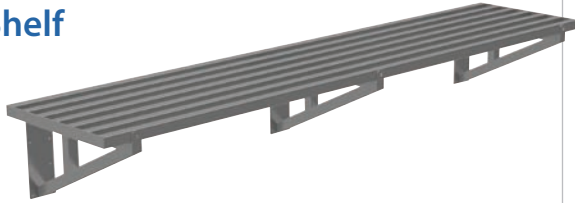

**TA-26-21 \$311 per shelf**  
Optional Factory Welded Shelf Brackets (Print Required)

Length	Model #	Price	# of Brackets	Approx. Wt.	Approx. Cubes
48"	DT21-4	\$3334	2	90 lbs.	6
72"	DT21-6	5001	3	105 lbs.	8
96"	DT21-8	6668	3	145 lbs.	10
120"	DT21-10	8335	4	190 lbs.	13
144"	DT21-12	10001	4	210 lbs.	15

### with Built-In Check Minder



Floating Ball Mechanism Quickly Grabs Checks And Holds Them In Place

Length	12" WIDE	Price	Approx. Wt.	Approx. Cubes
3'	WS-12-36CM	\$357	15 lbs.	4
4'	WS-12-48CM	396	19 lbs.	5
5'	WS-12-60CM	428	21 lbs.	6
6'	WS-12-72CM	456	25 lbs.	7
8'	WS-12-96CM	539	32 lbs.	10

**NOTE: Recommend Field Welding Brackets To Underside Of Cook Line Shelf**

### with Built-In Pot Rack

Length	12" WIDE	Price	15" WIDE	Price	18" WIDE	Price	# of Hooks	Approx. Wt.	Approx. Cubes
3'	PS-12-36	\$726	PS-15-36	\$876	PS-18-36	\$1114	6	30 lbs.	5
4'	PS-12-48	765	PS-15-48	920	PS-18-48	1192	6	40 lbs.	6
5'	PS-12-60	798	PS-15-60	945	PS-18-60	1217	9	50 lbs.	7
6'	PS-12-72	825	PS-15-72	979	PS-18-72	1280	9	60 lbs.	8
7'	PS-12-84	866	PS-15-84	992	PS-18-84	1350	9	70 lbs.	10
8'	PS-12-96	908	PS-15-96	1064	PS-18-96	1398	9	80 lbs.	11
9'	PS-12-108	951	PS-15-108	1245	PS-18-108	1540	9	90 lbs.	12
10'	PS-12-120	1024	PS-15-120	1265	PS-18-120	1581	9	100 lbs.	13
11'	PS-12-132	1054	PS-15-132	1370	PS-18-132	1635	9	110 lbs.	14
12'	PS-12-144	1071	PS-15-144	1419	PS-18-144	1687	9	120 lbs.	26



**FOR CHECK MINDER PROVISION**  
On Any Shelf Use

**TA-77**  
\$53 /lin. ft.



- TA-60** Special Sizing Charge for Wall Shelves
- TA-99** 16 ga. 304 Upgrade for Wall and Over Shelves
- TA-99A** 14 Ga. S/S 304 Upgrade for Wall & Over Shelves

**N/C - Add to next longer shelf**  
\$24 / lin. ft.  
43/lin. ft.

### Wall Shelf w/Multipurpose Undershelf



Shown with Microwave Units (Not Included)

- 5 1/2" Undershelf
- Upper & Lower Grommet Holes

Size W x L	Model #	Price	Approx. Wt.	Approx. Cubes
24" x 24"	MS-24-24-PS	\$1324	58 lbs.	11
24" x 36"	MS-24-36-PS	1549	85 lbs.	16
24" x 48"	MS-24-48-PS	1774	110 lbs.	21

### Microwave Shelf

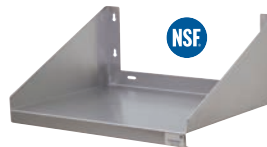

Size W x L	Model #	Price	Approx. Wt.	Approx. Cubes
18" x 24"	MS-18-24	\$506	27 lbs.	5
24" x 24"	MS-24-24	574	32 lbs.	5
24" x 36"	MS-24-36	799	38 lbs.	7
20" x 30"	MS-20-30	739	36 lbs.	5

**TA-108 \$130**  
2" Hole with Grommet For Appliance Cord.  
(Please Specify Hole Size And Location)



### 8" Wide Utility Shelf

Length	Model #	Price	Approx. Wt.	Approx. Cubes
24"	K-245	\$716	50 lbs.	1
36"	K-246	813	55 lbs.	2

## STAINLESS STEEL WALL FLASHING

Wall Flashing supplied in 10' Lengths.

- Available in 16 Gauge, 18 Gauge and 20 Gauge
- Type 304 Stainless Steel
- Polished to a Commercial Grade #3 Finish

### OPTIONAL WALL FLASHING ACCESSORIES







Model #	Description	Price
WF16	16 Gauge	\$51 /sq. ft.
WF18	18 Gauge	42 /sq. ft.
WF20	20 Gauge	39 /sq. ft.

Model #	Description	Price
WF-SC-1	Seam Cap	\$95 ea.
WF-EC-1	Edge Cap	95 ea.
WF-IC-1	Inside Corner	106 ea.









## Single Shelf

 = Ship Via UPS

Length	Model #	Price	Approx. Wt.	Approx. Cubes
3'	 CM-18-36	\$2448	24 lbs.	4
4'	 CM-18-48	2625	29 lbs.	5
5'	 CM-18-60	2798	35 lbs.	6
6'	 CM-18-72	2973	40 lbs.	7
7'	 CM-18-84	2978	46 lbs.	8
8'	 CM-18-96	3054	51 lbs.	9

## Double Shelves

Length	Model #	Price	Approx. Wt.	Approx. Cubes
3'	 DCM-18-36	\$3147	55 lbs.	5
4'	 DCM-18-48	3672	60 lbs.	6
5'	 DCM-18-60	3847	66 lbs.	7
6'	 DCM-18-72	4373	72 lbs.	8
7'	 DCM-18-84	4434	78 lbs.	9
8'	 DCM-18-96	4580	84 lbs.	10

- Stainless Steel
- 1 5/8" Stainless Steel Posts
- Shipped KD
- Load Capacity is 5 lbs. per sq. ft. (Evenly Distributed)

**CUSTOMER MUST SPECIFY CEILING HEIGHT**

# SHELVING

## Shelving & Modifications

### 18" WIDE CEILING MOUNTED SHELVING

SINGLE



DOUBLE



## SHELVING MODIFICATIONS

FACTORY INSTALLED ONLY

### Printer Shelf

- Heavy gauge stainless steel
- 8"x16" Printer Deck
- 10" height
- 1 Data Port Receptacle
- 1 Electrical Receptacle
- Rear Gem Box with Removable Enclosure
- Turned up front edge to hold Printer in place



**PRT-1 \$794/shelf**

Back of Shelf Shown

### Check Minder



- Extruded Anodized Aluminum
- Holds checks with ease
- Floating ball mechanism quickly grabs checks & holds them in place
- Mounts to any shelf

**TA-77 \$53 /lin. ft.**

**TA-77A \$37 /lin. ft.**

Concealer for Heat Lamp. (Requires a TA-77)

### Microwave Shelf Extension

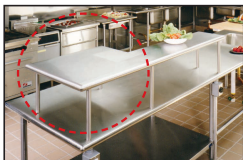

24" Front to Back  
1-5/8" Posts

Use the full length of OTS Shelves found on page 66 and then add **TA-102 \$387** extension. Specify Right or Left.

### Table Mounted Equipment Shelf



1-5/8" Posts

L	Model #	Price	Approx. Wt.	Approx. Cubes
2'	<b>MST-24-24</b>	<b>\$1048</b>	32 lbs.	1
3'	<b>MST-24-36</b>	<b>1225</b>	38 lbs.	2

### 6" Shelf Offset



- Posts located towards rear shelf
- Provides shelf reach
- Available for 18" or Wider shelving Only (CU Series Shelving)





**TA-120 \$116/Per level**

## Accessories

### Check Minder Accessory



- Holds Checks With Ease
- Floating Ball Mechanism Quickly Grabs Checks & Holds Them In Place
- Mounts To Existing Wall Or Shelf

Length	Model #	Price	Approx. Wt.
2'	 <b>CM-24</b>	<b>\$39</b>	1.5 lbs.
3'	 <b>CM-36</b>	<b>51</b>	2.25 lbs.
4'	 <b>CM-48</b>	<b>66</b>	3 lbs.
5'	 <b>CM-60</b>	<b>77</b>	4.25 lbs.

### Wall Cap



- 16 ga., 304 Stainless Steel
- 2" x Wall Thickness x 2" x Height



Model #	Price
 <b>WALLCAP</b>	<b>\$51 Lin. ft.</b>

**MUST SPECIFY:**  
Wall thickness (maximum 6")  
Height (Maximum of 10 feet)  
Minimum charge 4 linear feet

### Bumper Guards









- 16 ga., 304 Stainless Steel
- Bracket Included

Model #	Size	Price
 <b>BG-48</b>	2" x 4" x 48"	<b>\$193</b>
 <b>BG-60</b>	2" x 4" x 60"	<b>261</b>

### Corner Guards



- 16 ga., 304 Stainless Steel
- Adhesive Tape Backing

2" x 2"		
Model #	Size	Price
 <b>CG-48</b>	2" x 2" x 48"	<b>\$130</b>
 <b>CG-60</b>	2" x 2" x 60"	<b>172</b>
 <b>CG-72</b>	2" x 2" x 72"	<b>192</b>
 <b>CG-84</b>	2" x 2" x 84"	<b>227</b>
 <b>CG-96</b>	2" x 2" x 96"	<b>236</b>
 <b>CG-120</b>	2" x 2" x 120"	<b>269</b>
4" x 4"		
 <b>OCG-48-SS</b>	4" x 4" x 48"	<b>248</b>



# POT RACKS

## Adjustable Pot Rack Components



**#1** HOW TO ORDER  
Select from 3 Mounting Provisions

*Mid, Rear or Splash*

**#2** Choose Desired Components

**NOT ONLY STURDY BUT ADJUSTABLE!**

TABLE with POT RACK, SHELVING & UTENSIL RACK  
MID MOUNT DESIGN



MIX & MATCH to Maximize Your Work Area. Components are Adjustable. You set the Height to Meet Your Demanding Requirement.

### SPECIFY MOUNTING PROVISION

FOR MID MOUNT  
Add TA-228 N/C



FOR REAR MOUNT  
ADD TA-229 N/C



FOR SPLASH MOUNT  
ADD TA-227 N/C



### Pot Racks (Includes Utensil Rack)

### Utensil Racks

Length	Model #	# of Pot Hooks	Price	Approx. Wt.	Approx. Cubes	Model #	# of Pot Hooks	Price	Approx. Wt.	Approx. Cubes
36"	SCT-36	12	\$1321	30	5	AUR-36	6	\$499	30	2
48"	SCT-48	12	1370	34	6	AUR-48	6	507	34	3
60"	SCT-60	18	1408	37	7	AUR-60	9	543	37	3
72"	SCT-72	18	1939	46	9	AUR-72	9	569	46	4
84"	SCT-84	18	1987	50	10	AUR-84	9	667	50	5
96"	SCT-96	18	2122	55	12	AUR-96	9	730	55	5
108"	SCT-108	18	2583	60	13	AUR-108	9	917	60	6
120"	SCT-120	18	2799	65	15	AUR-120	9	973	65	7
132"	SCT-132	18	2876	68	16	AUR-132	9	1101	68	7
144"	SCT-144	18	2932	72	18	AUR-144	9	1224	72	8
36"	SWT-36	12	1050	30	5	AUR-36	6	499	30	2
48"	SWT-48	12	1076	34	6	AUR-48	6	507	34	3
60"	SWT-60	18	1089	37	7	AUR-60	9	543	37	3
72"	SWT-72	18	1101	46	9	AUR-72	9	569	46	4
84"	SWT-84	18	1321	50	10	AUR-84	9	667	50	5
96"	SWT-96	18	1344	55	12	AUR-96	9	730	55	5
108"	SWT-108	18	1597	60	13	AUR-108	9	917	60	6
120"	SWT-120	18	1615	65	15	AUR-120	9	973	65	7
132"	SWT-132	18	1653	68	16	AUR-132	9	1101	68	7
144"	SWT-144	18	1691	72	18	AUR-144	9	1224	72	8
36"	SWT-36	12	1050	30	5	AUR-36	6	499	30	2
48"	SWT-48	12	1076	34	6	AUR-48	6	507	34	3
60"	SWT-60	18	1089	37	7	AUR-60	9	543	37	3
72"	SWT-72	18	1101	46	9	AUR-72	9	569	46	4
84"	SWT-84	18	1321	50	10	AUR-84	9	667	50	5
96"	SWT-96	18	1344	55	12	AUR-96	9	730	55	5
108"	SWT-108	18	1597	60	13	AUR-108	9	917	60	6
120"	SWT-120	18	1615	65	15	AUR-120	9	973	65	7
132"	SWT-132	18	1653	68	16	AUR-132	9	1101	68	7
144"	SWT-144	18	1691	72	18	AUR-144	9	1224	72	8

Pot Racks 8' Or Longer, Include Center Leg Support

# SHELVING

## Adjustable Shelving Components

### Convert Your Table into an Effective Work Station

**Table with OVERHEAD SHELVES  
REAR MOUNT CANTILEVERED DESIGN**

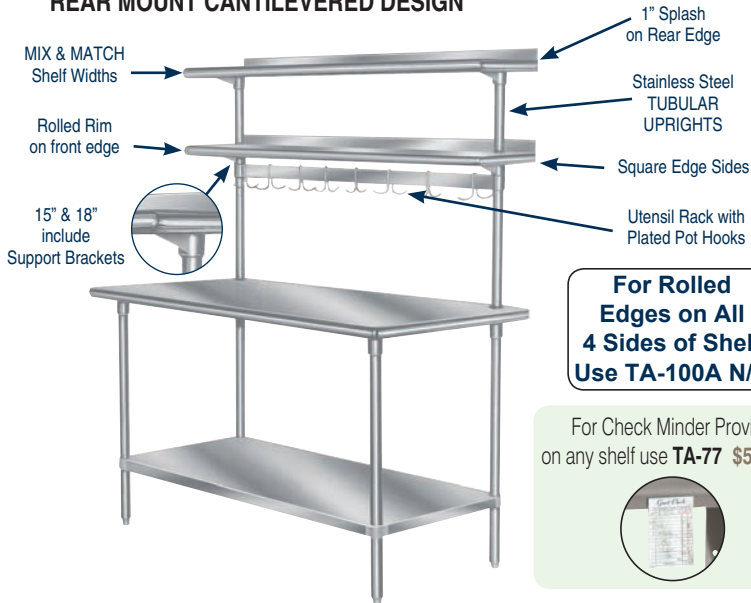

**Table with SHELVES, POT RACK & UTENSIL RACK  
SPLASH MOUNT DESIGN**

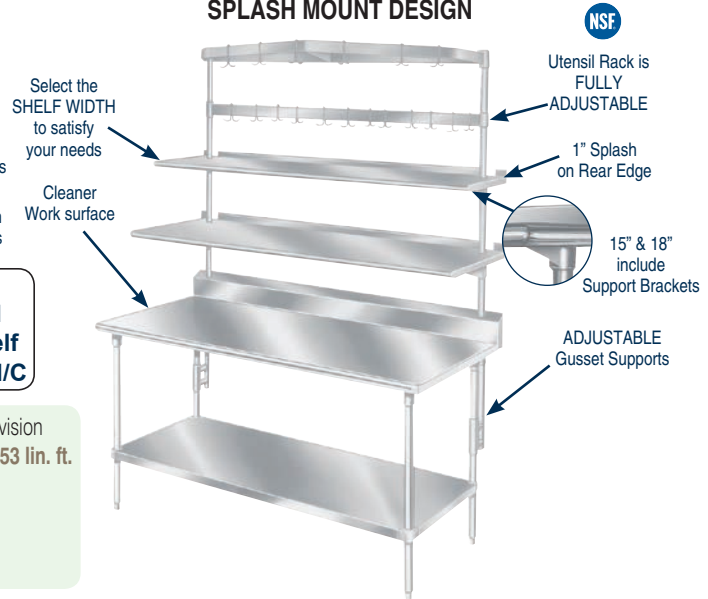

**For Rolled Edges on All 4 Sides of Shelf Use TA-100A N/C**

For Check Minder Provision on any shelf use **TA-77 \$53 lin. ft.**



*ADD - CHANGE - MODIFY with Components to Meet the Demanding Prep-Requirements of an Upgrading or Changing Food Service Environment*

### Adjustable Shelves

Length	10" WIDE	Price	12" WIDE	Price	15" WIDE	Price	18" WIDE	Price	Approx. Wt.	Approx. Cubes
36"	PT-10-36	\$441	PT-12-36	\$462	PT-15-36	\$798	PT-18-36	\$958	30	2
48"	PT-10-48	472	PT-12-48	493	PT-15-48	850	PT-18-48	1003	34	3
60"	PT-10-60	496	PT-12-60	529	PT-15-60	896	PT-18-60	1078	37	3
72"	PT-10-72	519	PT-12-72	558	PT-15-72	1037	PT-18-72	1173	46	4
84"	PT-10-84	543	PT-12-84	587	PT-15-84	1074	PT-18-84	1228	50	5
96"	PT-10-96	619	PT-12-96	661	PT-15-96	1125	PT-18-96	1303	55	5
108"	PT-10-108	992	PT-12-108	1060	PT-15-108	1291	PT-18-108	1444	60	6
120"	PT-10-120	1091	PT-12-120	1149	PT-15-120	1426	PT-18-120	1557	65	7
132"	PT-10-132	1169	PT-12-132	1246	PT-15-132	1538	PT-18-132	1705	68	7
144"	PT-10-144	1251	PT-12-144	1309	PT-15-144	1695	PT-18-144	1822	72	8
36"	PT-10R-36	519	PT-12R-36	540	PT-15R-36	871	PT-18R-36	985	30	2
48"	PT-10R-48	544	PT-12R-48	576	PT-15R-48	913	PT-18R-48	1057	34	3
60"	PT-10R-60	576	PT-12R-60	612	PT-15R-60	965	PT-18R-60	1161	37	3
72"	PT-10R-72	608	PT-12R-72	649	PT-15R-72	1077	PT-18R-72	1251	46	4
84"	PT-10R-84	639	PT-12R-84	688	PT-15R-84	1146	PT-18R-84	1301	50	5
96"	PT-10R-96	720	PT-12R-96	775	PT-15R-96	1255	PT-18R-96	1438	55	5
108"	PT-10R-108	1189	PT-12R-108	1289	PT-15R-108	1438	PT-18R-108	1562	60	6
120"	PT-10R-120	1283	PT-12R-120	1435	PT-15R-120	1521	PT-18R-120	1635	65	7
132"	PT-10R-132	1381	PT-12R-132	1553	PT-15R-132	1680	PT-18R-132	1824	68	7
144"	PT-10R-144	1471	PT-12R-144	1627	PT-15R-144	1819	PT-18R-144	1939	72	8
36"	PT-10S-36	663	PT-12S-36	688	PT-15S-36	1013	PT-18S-36	1186	30	2
48"	PT-10S-48	697	PT-12S-48	725	PT-15S-48	1074	PT-18S-48	1275	34	3
60"	PT-10S-60	725	PT-12S-60	757	PT-15S-60	1121	PT-18S-60	1309	37	3
72"	PT-10S-72	754	PT-12S-72	799	PT-15S-72	1211	PT-18S-72	1380	46	4
84"	PT-10S-84	789	PT-12S-84	835	PT-15S-84	1320	PT-18S-84	1546	50	5
96"	PT-10S-96	886	PT-12S-96	939	PT-15S-96	1411	PT-18S-96	1607	55	5
108"	PT-10S-108	1426	PT-12S-108	1541	PT-15S-108	1676	PT-18S-108	1797	60	6
120"	PT-10S-120	1529	PT-12S-120	1625	PT-15S-120	1743	PT-18S-120	1924	65	7
132"	PT-10S-132	1609	PT-12S-132	1715	PT-15S-132	1837	PT-18S-132	2012	68	7
144"	PT-10S-144	1687	PT-12S-144	1746	PT-15S-144	1919	PT-18S-144	2111	72	8

**Shelves 8' Or Longer, Include Center Leg Support**

# POT RACKS

## Additional Pot Racks

### WALL MOUNTED POT RACKS

Includes Pot Hooks

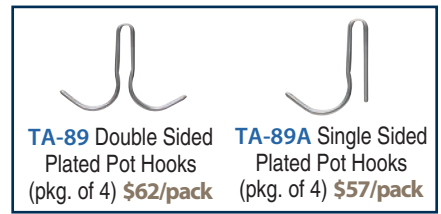

Length	Stainless Steel		Powder Coated		# Of Hooks	Wt.	Aluminum		# Of Hooks	Wt.	Cu.
	Model #	Price	Model #	Price			Model #	Price			
2'	NOT AVAILABLE						ALW-24	\$305	6	5 lbs.	1.0
3'	SW1-36	\$571	GW1-36	\$301	6	13 lbs.	ALW-36	376	6	6 lbs.	1.5
4'	SW1-48	588	GW1-48	335	6	15 lbs.	ALW-48	410	6	7 lbs.	2.0
5'	SW1-60	605	GW1-60	370	9	17 lbs.	NOT AVAILABLE				
6'	SW1-72	624	GW1-72	384	9	19 lbs.					
7'	SW1-84	639	GW1-84	401	9	21 lbs.					
8'	SW1-96	703	GW1-96	437	9	23 lbs.					
9'	SW1-108	773	GW1-108	455	9	25 lbs.					
10'	SW1-120	841	GW1-120	471	9	27 lbs.					

### Single Bar



Length	Stainless Steel		Powder Coated		# Of Hooks	Wt.	Cu.
	Model #	Price	Model #	Price			
2'	SW-24	\$790	GW-24	\$535	12	18 lbs.	4
3'	SW-36	857	GW-36	608	12	22 lbs.	5
4'	SW-48	886	GW-48	636	12	26 lbs.	6
5'	SW-60	952	GW-60	666	18	30 lbs.	7
6'	SW-72	1000	GW-72	683	18	34 lbs.	9
7'	SW-84	1104	GW-84	739	18	44 lbs.	10
8'	SW-96	1146	GW-96	756	18	48 lbs.	12
9'	SW-108	1354	GW-108	952	18	52 lbs.	13
10'	SW-120	1482	GW-120	1101	18	56 lbs.	15
11'	SW-132	1608	GW-132	1224	18	60 lbs.	16
12'	SW-144	1700	GW-144	1253	18	64 lbs.	18

### Double Bar



SW-36 Shown

### CEILING MOUNTED POT RACKS

Hangs 36" From Ceiling • Includes Pot Hooks



Length	Stainless Steel		Powder Coated		# Of Hooks	Wt.	Cu.
	Model #	Price	Model #	Price			
3'	SC-36	\$1470	GC-36	\$917	12	42 lbs.	5
4'	SC-48	1498	GC-48	928	12	48 lbs.	6
5'	SC-60	1561	GC-60	947	18	54 lbs.	7
6'	SC-72	1629	GC-72	972	18	60 lbs.	9
7'	SC-84	1817	GC-84	1203	18	66 lbs.	10
8'	SC-96	2055	GC-96	1329	18	80 lbs.	12
9'	SC-108	2291	GC-108	1668	18	86 lbs.	13
10'	SC-120	2565	GC-120	1841	18	92 lbs.	15
11'	SC-132	2704	GC-132	1956	18	98 lbs.	16
12'	SC-144	3001	GC-144	2138	18	104 lbs.	18

TA-98 Stainless Steel Flat Bar in lieu of Chain \$282/pot rack

### LEG MOUNTED POT RACK

For 30" Wide Tables

Includes 6 Pot Hooks Per Unit



Stainless Steel

**UB-30**   
**\$375**  
 Wt. 10 lbs.

For Adjustable Pot Rack Components  
See Page 74

# DISHTABLE STANDARDS



Shown with 8" Deep Sink Bowl, Pre-rinse Basket & Slide Bar

## Features and Benefits

- 3/4" Radius Corner Sink Bowls
- 10 1/2" Tile Edge Backsplash
- 1 5/8" Tubular Legs
- Economical Savings
- Satin Finish

## SPEC-LINE "30" Series

- 14 ga. 304 Stainless Steel Top
- Stainless Steel Cross Bracing on Sides
- 16 ga. 304 Stainless Steel Legs & Adjust. Bullet Feet
- 10 1/2" Backsplash
- 8" Deep Sink Bowls (Soil Units)



## STANDARD "70" Series

- 16 ga. 304 Stainless Steel Top
- Stainless Steel Cross Bracing on Sides
- Stainless Steel Legs and Adjust. Bullet Feet
- 10 1/2" Backsplash
- 5" Deep Sink Bowls (Soil Units)



## SUPERSAVER "60" Series

- 16 ga. 304 Stainless Steel Top
- Galvanized Legs & Adjust. Plastic Bullet Feet
- 10 1/2" Backsplash
- 5" Deep Sink Bowls (Soil Units)



**WHEN PLACING AN ORDER, PLEASE PROVIDE THE DISH MACHINE MODEL NUMBER TO ENSURE PROPER DISHTABLE COMPATIBILITY.**

Due to some machine manufacturer's recommendations for specific service access, the following modifications will apply...

### **DTA-76 (Relocate sink location)**

*Dish Machines that require a **DTA-76**:*

ES-4400, ES-6600, WH-series, APEX TSC-V  
CMA 180 (Right-side), 44, 66  
Hobart AM-15 (corner configuration) C-series, CL-series,  
CCS-66/77/86/110, CRS-series  
Jackson AJ-series, TS-series, TSC-series  
Meiko K-series  
Stero SCT-series

**DTA-76: No Charge**

### **DTA-78 (Notch in backsplash to clear handle)**

*Dish Machines that require a **DTA-78**:*

ADS HT-25, SS-25  
Blakeslee D-8, D-9  
Ecolab ES-4000  
Electrolux WT65  
Hobart AM-15 (Corner Configuration)  
**DTA-78: \$138**



# Soil Dishtables



**! ATTENTION:**  
See Dish Machine Information on Pg. 77 to ensure proper compatibility

## STRAIGHT SOIL DISHTABLES

**Spec-Line S30 Series**      **Standard S70 Series**      **Super Saver S60 Series**  
**14 Ga.**      **16 Ga.**      **16 Ga. w/ Galvanized Legs**

Nominal Size	Length	Model #	Price	Model #	Price	Model #	Price	Approx. Weight	Approx. Cu. Ft.
3 Ft.	35"	DTS-S30-36LorR	\$3224	DTS-S70-36LorR	\$2718	DTS-S60-36LorR	\$2588	70 lbs.	12
4 Ft.	47"	DTS-S30-48LorR	3379	DTS-S70-48LorR	2809	DTS-S60-48LorR	2681	85 lbs.	17
5 Ft.	59"	DTS-S30-60LorR	3456	DTS-S70-60LorR	2903	DTS-S60-60LorR	2774	100 lbs.	19
6 Ft.	71"	DTS-S30-72LorR	3590	DTS-S70-72LorR	3051	DTS-S60-72LorR	2923	115 lbs.	23
7 Ft.	83"	DTS-S30-84LorR	3695	DTS-S70-84LorR	3274	DTS-S60-84LorR	3088	125 lbs.	27
8 Ft.	95"	DTS-S30-96LorR	3747	DTS-S70-96LorR	3475	DTS-S60-96LorR	3140	135 lbs.	31
9 Ft.	107"	DTS-S30-108LorR	4450	DTS-S70-108LorR	3737	DTS-S60-108LorR	3583	235 lbs.	45
10 Ft.	119"	DTS-S30-120LorR	4762	DTS-S70-120LorR	4109	DTS-S60-120LorR	3925	290 lbs.	50
12 Ft.	143"	DTS-S30-144LorR	5511	DTS-S70-144LorR	4503	DTS-S60-144LorR	4319	320 lbs.	60

Faucet Holes are Splash Mounted 8" O.C.

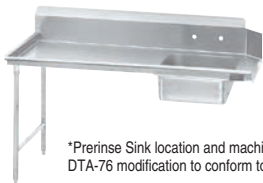

\*Pre-rinse Sink location and machine opening may require DTA-76 modification to conform to Dishmachine requirements.

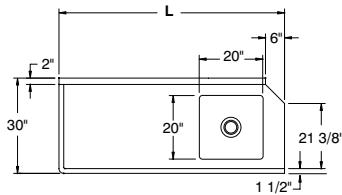

LEFT SOIL TABLE

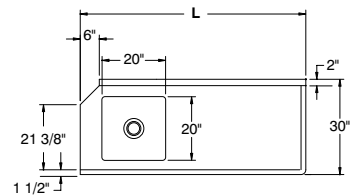

RIGHT SOIL TABLE



## CORNER SOIL DISHTABLES

**Spec-Line K30 Series**      **Standard K70 Series**      **Super Saver K60 Series**  
**14 Ga.**      **16 Ga.**      **16 Ga. w/ Galvanized Legs**

Nominal Size	Length	Model #	Price	Model #	Price	Model #	Price	Approx. Weight	Approx. Cu. Ft.
4 Ft.	47"	DTS-K30-48LorR	\$5923	DTS-K70-48LorR	\$5414	DTS-K60-48LorR	\$5175	128 lbs.	29
5 Ft.	59"	DTS-K30-60LorR	6064	DTS-K70-60LorR	5502	DTS-K60-60LorR	5294	138 lbs.	37
6 Ft.	71"	DTS-K30-72LorR	6170	DTS-K70-72LorR	5639	DTS-K60-72LorR	5442	149 lbs.	44
7 Ft.	83"	DTS-K30-84LorR	6342	DTS-K70-84LorR	5765	DTS-K60-84LorR	5612	163 lbs.	51
8 Ft.	95"	DTS-K30-96LorR	6448	DTS-K70-96LorR	5908	DTS-K60-96LorR	5670	182 lbs.	58
9 Ft.	107"	DTS-K30-108LorR	6683	DTS-K70-108LorR	6210	DTS-K60-108LorR	5919	355 lbs.	83
10 Ft.	119"	DTS-K30-120LorR	7007	DTS-K70-120LorR	6747	DTS-K60-120LorR	6053	380 lbs.	92
12 Ft.	143"	DTS-K30-144LorR	7741	DTS-K70-144LorR	7132	DTS-K60-144LorR	6962	390 lbs.	110

Faucet Holes are Splash Mounted 8" O.C.



\*Pre-rinse Sink location and machine opening may require DTA-76 modification to conform to Dishmachine requirements.

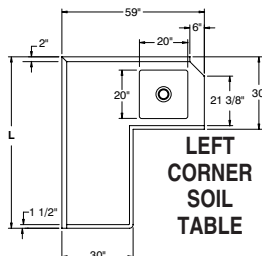

LEFT CORNER SOIL TABLE

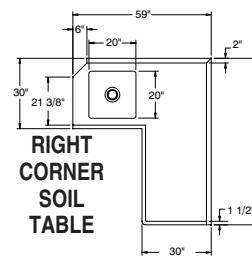

RIGHT CORNER SOIL TABLE

**! ATTENTION:**

See Dish Machine Information on Pg. 77 to ensure proper compatibility



# DISHTABLES

## Soil Dishtables

### ISLAND SOIL DISHTABLES

**Spec-Line G30 Series**

**Standard G70 Series**

**Super Saver G60 Series**

14 Ga.

16 Ga.

16 Ga. w/ Galvanized Legs

Nominal Size	Length	Model #	Price	Model #	Price	Model #	Price	Approx. Weight	Approx. Cu. Ft.
4 Ft.	47"	DTS-G30-48LorR	\$5546	DTS-G70-48LorR	\$5079	DTS-G60-48LorR	\$4857	129 lbs.	29
5 Ft.	59"	DTS-G30-60LorR	5671	DTS-G70-60LorR	5171	DTS-G60-60LorR	4969	138 lbs.	37
6 Ft.	71"	DTS-G30-72LorR	5818	DTS-G70-72LorR	5294	DTS-G60-72LorR	5116	150 lbs.	44
7 Ft.	83"	DTS-G30-84LorR	5943	DTS-G70-84LorR	5450	DTS-G60-84LorR	5281	162 lbs.	51
8 Ft.	95"	DTS-G30-96LorR	6046	DTS-G70-96LorR	5563	DTS-G60-96LorR	5333	178 lbs.	58
9 Ft.	107"	DTS-G30-108LorR	6203	DTS-G70-108LorR	5831	DTS-G60-108LorR	5725	335 lbs.	83
10 Ft.	119"	DTS-G30-120LorR	6463	DTS-G70-120LorR	6329	DTS-G60-120LorR	6210	365 lbs.	92
12 Ft.	143"	DTS-G30-144LorR	6814	DTS-G70-144LorR	6679	DTS-G60-144LorR	6571	380 lbs.	110



\*Prerinse Sink location and machine opening may require DTA-76 modification to conform to Dishmachine requirements.

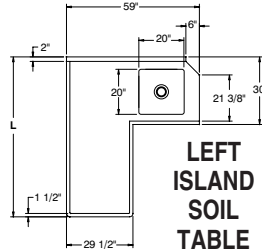

**LEFT ISLAND SOIL TABLE**

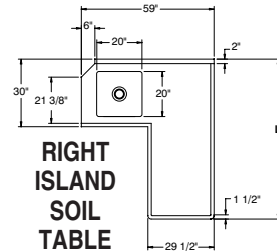

**RIGHT ISLAND SOIL TABLE**

Faucet Holes are Splash Mounted 8" O.C.

### DISHLANDING SOIL DISHTABLES

**Spec-Line D30 Series**

**Standard D70 Series**

**Super Saver D60 Series**

14 Ga.

16 Ga.

16 Ga. w/ Galvanized Legs

Nominal Size	Length	Model #	Price	Model #	Price	Model #	Price	Approx. Weight	Approx. Cu. Ft.
4 Ft.	47"	DTS-D30-48LorR	\$6640	DTS-D70-48LorR	\$6049	DTS-D60-48LorR	\$5921	139 lbs.	33
5 Ft.	59"	DTS-D30-60LorR	6779	DTS-D70-60LorR	6172	DTS-D60-60LorR	6077	147 lbs.	41
6 Ft.	71"	DTS-D30-72LorR	6957	DTS-D70-72LorR	6311	DTS-D60-72LorR	6196	160 lbs.	50
7 Ft.	83"	DTS-D30-84LorR	7170	DTS-D70-84LorR	6450	DTS-D60-84LorR	6337	175 lbs.	58
8 Ft.	95"	DTS-D30-96LorR	7220	DTS-D70-96LorR	6596	DTS-D60-96LorR	6451	205 lbs.	66
9 Ft.	107"	DTS-D30-108LorR	7562	DTS-D70-108LorR	6743	DTS-D60-108LorR	6604	320 lbs.	93
10 Ft.	119"	DTS-D30-120LorR	7866	DTS-D70-120LorR	7134	DTS-D60-120LorR	6962	365 lbs.	103
12 Ft.	143"	DTS-D30-144LorR	8210	DTS-D70-144LorR	7441	DTS-D60-144LorR	7306	390 lbs.	123



\*Prerinse Sink location and machine opening may require DTA-76 modification to conform to Dishmachine requirements.

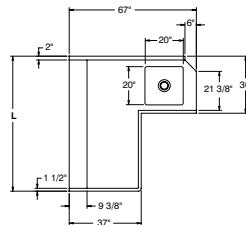

**LEFT DISHLANDING SOIL TABLE**

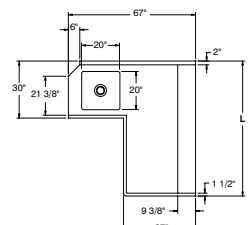

**RIGHT DISHLANDING SOIL TABLE**

# DISHTABLES

## Clean Dishtables

**! ATTENTION:**  
See Dish Machine Information on Pg. 77 to ensure proper compatibility

### STRAIGHT CLEAN DISHTABLES

**Spec-Line S30 Series**

**Standard S70 Series**

**Super Saver S60 Series**

14 Ga.

16 Ga.

16 Ga. w/ Galvanized Legs

Nominal Size	Length	Model #	Price	Model #	Price	Model #	Price	Approx. Weight	Approx. Cu. Ft.
2 Ft.	23"	DTC-S30-24LorR	\$1590	DTC-S70-24LorR	\$1504	DTC-S60-24LorR	\$1369	35 lbs.	12
3 Ft.	35"	DTC-S30-36LorR	1929	DTC-S70-36LorR	1726	DTC-S60-36LorR	1591	45 lbs.	12
4 Ft.	47"	DTC-S30-48LorR	2019	DTC-S70-48LorR	1879	DTC-S60-48LorR	1745	60 lbs.	17
5 Ft.	59"	DTC-S30-60LorR	2151	DTC-S70-60LorR	1990	DTC-S60-60LorR	1855	70 lbs.	19
6 Ft.	71"	DTC-S30-72LorR	2270	DTC-S70-72LorR	2087	DTC-S60-72LorR	1952	85 lbs.	23
7 Ft.	83"	DTC-S30-84LorR	2755	DTC-S70-84LorR	2318	DTC-S60-84LorR	2129	100 lbs.	27
8 Ft.	95"	DTC-S30-96LorR	2884	DTC-S70-96LorR	2514	DTC-S60-96LorR	2181	110 lbs.	31
9 Ft.	107"	DTC-S30-108LorR	3207	DTC-S70-108LorR	2835	DTC-S60-108LorR	2674	225 lbs.	45
10 Ft.	119"	DTC-S30-120LorR	3333	DTC-S70-120LorR	3055	DTC-S60-120LorR	2869	250 lbs.	50
12 Ft.	143"	DTC-S30-144LorR	3665	DTC-S70-144LorR	3345	DTC-S60-144LorR	3151	270 lbs.	60



**NSF**  
Optional Undershelf

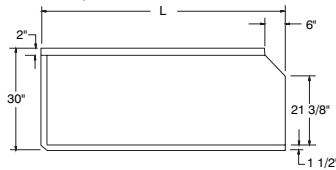

LEFT CLEAN TABLE

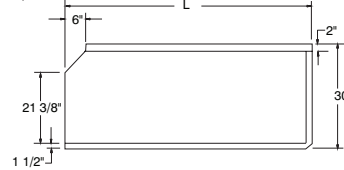

RIGHT CLEAN TABLE

### CORNER CLEAN DISHTABLES

**Spec-Line K30 Series**

**Standard K70 Series**

**Super Saver K60 Series**

14 Ga.

16 Ga.

16 Ga. w/ Galvanized Legs

Nominal Size	Length	Model #	Price	Model #	Price	Model #	Price	Approx. Weight	Approx. Cu. Ft.
4 Ft.	47"	DTC-K30-48LorR	\$4259	DTC-K70-48LorR	\$3959	DTC-K60-48LorR	\$3716	105 lbs.	29
5 Ft.	59"	DTC-K30-60LorR	4380	DTC-K70-60LorR	4069	DTC-K60-60LorR	3813	115 lbs.	37
6 Ft.	71"	DTC-K30-72LorR	4569	DTC-K70-72LorR	4366	DTC-K60-72LorR	3983	125 lbs.	44
7 Ft.	83"	DTC-K30-84LorR	4784	DTC-K70-84LorR	4534	DTC-K60-84LorR	4154	138 lbs.	51
8 Ft.	95"	DTC-K30-96LorR	4834	DTC-K70-96LorR	4590	DTC-K60-96LorR	4206	157 lbs.	58
9 Ft.	107"	DTC-K30-108LorR	5993	DTC-K70-108LorR	5670	DTC-K60-108LorR	5345	330 lbs.	83
10 Ft.	119"	DTC-K30-120LorR	6279	DTC-K70-120LorR	5931	DTC-K60-120LorR	5549	360 lbs.	92
12 Ft.	143"	DTC-K30-144LorR	6906	DTC-K70-144LorR	6486	DTC-K60-144LorR	6105	380 lbs.	110



**NSF**

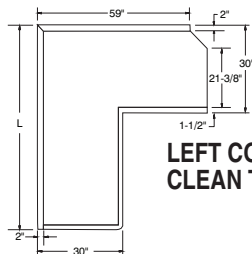

LEFT CORNER CLEAN TABLE

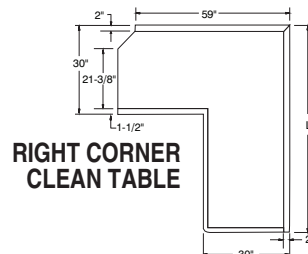

RIGHT CORNER CLEAN TABLE

**! ATTENTION:**

See Dish Machine Information on Pg. 77 to ensure proper compatibility

# DISHTABLES

## Clean Dishtables

### ISLAND CLEAN DISHTABLES

Spec-Line G30 Series

Standard G70 Series

Super Saver G60 Series

14 Ga.

16 Ga.

16 Ga. w/ Galvanized Legs

Nominal Size	Length	Model #	Price	Model #	Price	Model #	Price	Approx. Weight	Approx. Cu. Ft.
4 Ft.	47"	DTC-G30-48LorR	\$4139	DTC-G70-48LorR	\$3734	DTC-G60-48LorR	\$3591	102 lbs.	29
5 Ft.	59"	DTC-G30-60LorR	4261	DTC-G70-60LorR	3891	DTC-G60-60LorR	3694	112 lbs.	37
6 Ft.	71"	DTC-G30-72LorR	4449	DTC-G70-72LorR	3985	DTC-G60-72LorR	3859	125 lbs.	44
7 Ft.	83"	DTC-G30-84LorR	4657	DTC-G70-84LorR	4162	DTC-G60-84LorR	4030	135 lbs.	51
8 Ft.	95"	DTC-G30-96LorR	4711	DTC-G70-96LorR	4221	DTC-G60-96LorR	4083	148 lbs.	58
9 Ft.	107"	DTC-G30-108LorR	5832	DTC-G70-108LorR	5197	DTC-G60-108LorR	5023	310 lbs.	83
10 Ft.	119"	DTC-G30-120LorR	6038	DTC-G70-120LorR	5559	DTC-G60-120LorR	5306	340 lbs.	92
12 Ft.	143"	DTC-G30-144LorR	6642	DTC-G70-144LorR	6226	DTC-G60-144LorR	5845	360 lbs.	110

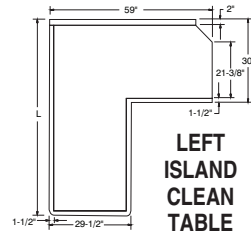

LEFT ISLAND CLEAN TABLE

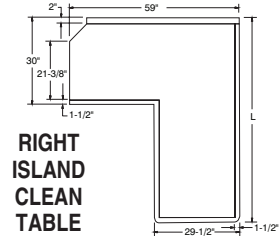

RIGHT ISLAND CLEAN TABLE

### U-SHAPED SOIL DISHTABLES

Nominal Size	Length	Model #	Price	Approx. Weight	Approx. Cu. Ft.
6 Ft.	71"	DTS-U30-72LorR	\$10711	450 lbs.	99
7 Ft.	83"	DTS-U30-84LorR	10917	470 lbs.	114
8 Ft.	95"	DTS-U30-96LorR*	11335	490 lbs.	130
9 Ft.	107"	DTS-U30-108LorR*	11628	525 lbs.	145
10 Ft.	119"	DTS-U30-120LorR*	11923	550 lbs.	160
11 Ft.	131"	DTS-U30-132LorR*	12111	575 lbs.	176
12 Ft.	143"	DTS-U30-144LorR*	12318	lbs. 600	192

\*Includes Field Joint (To be welded in field by others)

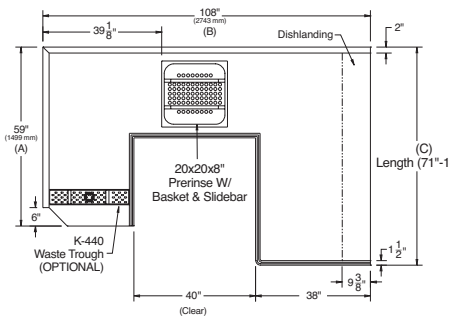

- Includes Prerinse sink basket and bar slide and dishlanding.
  - Additional length on any leg of dishtables, use **DTA-56 \$196** per ft. (Field joint may be required)
  - Additional custom lengths available on all sides.
  - If any 2 sides are larger than 90°, a welded field joint is required (WELDED BY OTHERS). USE **K-57 \$254**.
  - For additional accessories and modifications, see pages 82-84.
- Dishlanding may be replaced with backsplash or rolled edge at no additional charge.*

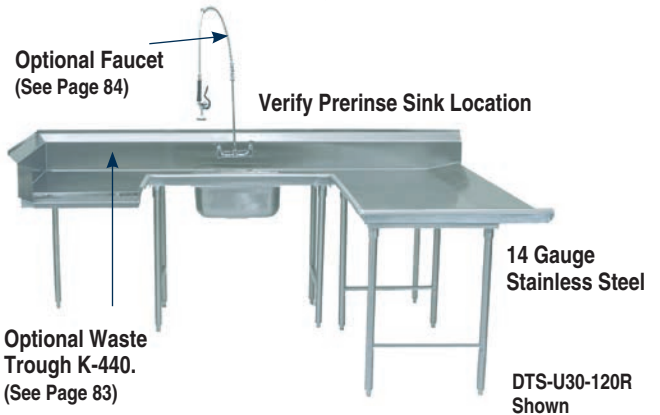

#### Prerinse Basket with Welded Slide Bar

All Stainless Steel  
Type 304 Series  
Perforated Basket for  
3/4" Radius Bowls

Model #	Size	Price
<b>DTA-100</b>	19 1/2" x 19 1/2"	<b>\$588</b>
	12 lbs. 1 Cu. Ft.	



4" Depth

#### Prerinse Slide Bar

Model #	Size	Price
<b>DTA-60</b>	19 1/2" x 19 1/2"	<b>\$337</b>
	9 lbs. 1 Cu. Ft.	

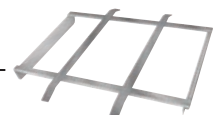



# DISHTABLES

## Specialty Dishtables

Faucets Can Be Found  
On Page 84

**! ATTENTION:**  
See Dish Machine Information on  
Pg. 77 to ensure proper compatibility

## DISHTABLE WITH 3 COMPARTMENT FABRICATED BOWLS



Multiple Bowl Choices & Lengths

- 16 Gauge Stainless Steel
- Stainless Steel Legs and Cross Rails
- Stainless Steel Bullet Feet

Model #	Length	Bowl Size	Drainboard Size	Approx. Weight	Price
<a href="#">DTC-3-1620-84LorR</a>	83"	16" x 20" x 12"	23"	220 lbs.	<b>\$6713</b>
<a href="#">DTC-3-1620-96LorR</a>	95"	16" x 20" x 12"	35"	240 lbs.	<b>7015</b>
<a href="#">DTC-3-1620-120LorR</a>	119"	16" x 20" x 12"	59"	265 lbs.	<b>7063</b>
<a href="#">DTC-3-1620-144LorR</a>	143"	16" x 20" x 12"	83"	290 lbs.	<b>7592</b>
<a href="#">DTC-3-1824-144LorR</a>	143"	18" x 24" x 14"	77"	365 lbs.	<b>9213</b>
<a href="#">DTC-3-2020-96LorR</a>	95"	20" x 20" x 12"	23"	260 lbs.	<b>7985</b>
<a href="#">DTC-3-2020-108LorR</a>	107"	20" x 20" x 12"	35"	285 lbs.	<b>8136</b>
<a href="#">DTC-3-2020-120LorR</a>	119"	20" x 20" x 12"	48"	310 lbs.	<b>8260</b>
<a href="#">DTC-3-2020-144LorR</a>	143"	20" x 20" x 12"	71"	340 lbs.	<b>8436</b>
<a href="#">DTC-3-2424-144LorR*</a>	143"	24" x 24" x 14"	59"	380 lbs.	<b>9394</b>



DTC-3-1620-84R Shown

**BOWLS ARE LOCATED 12" IN FROM MACHINE**  
For Other Configurations, Contact Factory  
(Must Verify Machine For Control Box Or Drive Unit Interference)

\* Requires Two Faucets

For Upgrade To 14 Gauge Use "DTA-49" \$560

### PRERINSE BASKETS & WELDED SLIDE BARS

#### Prerinse Baskets with Slide Bar

Model #	Fits Bowls	Price	Wt.	Cu.
<a href="#">DTA-125</a>	16" x 20" x 4"	<b>\$512</b>	9 lbs.	1
<a href="#">DTA-100</a>	20" x 20" x 4"	<b>588</b>	12 lbs.	1
<b>Large Size Baskets</b>				
<a href="#">DTA-58</a>	18" x 24" x 4"	<b>750</b>	11 lbs.	1
<a href="#">DTA-59</a>	24" x 24" x 4"	<b>853</b>	20 lbs.	1



DTA-100  
Shown

#### Prerinse Slide Bars

Model #	Fits Bowls	Price	Wt.	Cu.
<a href="#">DTA-64</a>	16" x 20"	<b>\$290</b>	7 lbs.	1
<a href="#">DTA-60</a>	20" x 20"	<b>337</b>	9 lbs.	1
<b>Large Size Prerinse Slide Bars</b>				
<a href="#">DTA-51</a>	18" x 24"	<b>425</b>	8 lbs.	1
<a href="#">DTA-52</a>	24" x 24"	<b>505</b>	10 lbs.	1

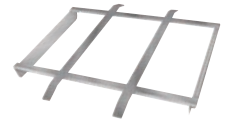

Prerinse Baskets & Slide Bar For Deep Drawn Bowls, See Page 83

### UNDERCOUNTER DISHTABLE

COMPACT - EFFICIENT - ECONOMICAL



DTU-U60-48R  
Shown

20" x 20" x 5"  
Sink Bowl

Left Or Right Designation Is  
Determined By Sink Location.

Length	Model #	Price	Approx. Weight	Approx. Cu. Ft.
48"	<a href="#">DTU-U60-48L</a>	<b>\$2603</b>	80 lbs.	17
48"	<a href="#">DTU-U60-48R</a>	<b>2603</b>	80 lbs.	17
60"	<a href="#">DTU-U60-60L</a>	<b>2741</b>	95 lbs.	19
60"	<a href="#">DTU-U60-60R</a>	<b>2741</b>	95 lbs.	19
72"	<a href="#">DTU-U60-72L</a>	<b>2850</b>	115 lbs.	23
72"	<a href="#">DTU-U60-72R</a>	<b>2850</b>	115 lbs.	23

### STAINLESS STEEL CONDENSATE HOODS



8" x 10" vent opening.  
Collar is centered 2" in height.

Model #	Length	Width	Height	Price
<a href="#">CH-3636</a>	36"	36"	20"	<b>\$3932</b>
<a href="#">CH-4242</a>	42"	42"	20"	<b>4233</b>
<a href="#">CH-4848</a>	48"	48"	20"	<b>4686</b>
<a href="#">CH-61</a>	Specify Alternate Collar Location			<b>165</b>
<a href="#">CH-56</a>	Additional Length Or Width			<b>482 /lin. Ft.</b>

This Item Is Not UL Or NFPA Listed.

### VENT RISER

- Type 300 Stainless Steel
- Adjustable Ceiling Trim Collar
- Accommodates Standard 4" x 16" Vent Hood Duct

(Custom Sizes Available - Consult Factory)

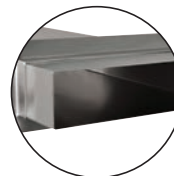

View of Opening

Model #	Length	Width	Height	Price
<a href="#">VR-1</a>	16"	4"	60"	<b>\$1875</b>

This Item Is Not UL Or NFPA Listed.



# Dishtable Mods

## Dishtable Modifications & Accessories

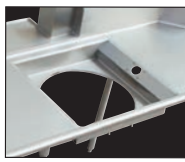

DTA-95

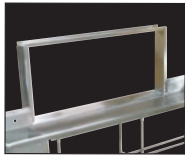

DTA-87



DTA-82



DTA-45

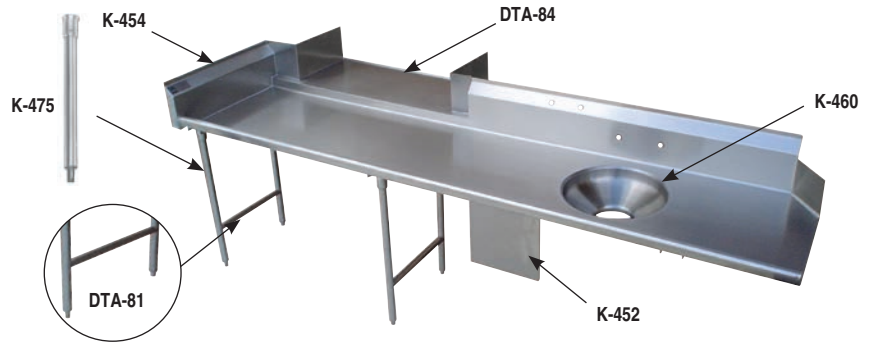

## MODIFICATIONS

K-23	Welded Set-Up/Crated	\$382 /sink
K-24	Shell Crating	282
K-37	Anti-Siphon Vacuum Breaker Hole	115
K-57	Welded Field Joint (Welded In Field By Others)	254
K-76	Paint On Sound Deadening	509 /sink
K-77	Splash Cut-Out (Pipe Chase)	180
K-440	Waste Trough Installation Welded Into Table And Furnished With A 2" Deep Removable Basket	870
K-452	Control Bracket 8" x 12"	254 ea.
K-453	Control Bracket 14" x 16"	273 ea.
K-454	Side Splash	395 ea.
K-456	Scrap Block Installed (Includes Rubber Scrap Block)	371 ea.
K-460	Disposal Cone Welded Into Table And Furnished With 8" x 12" Control Bracket & Faucet Holes (Supplied By Others)	760
K-460A	Installation Of Disposal Cone With 14" x 16" Control Bracket, Faucet Holes (Cone Supplied By Others)	808
K-461	Disposal Collar Welded Into Sink Bowl And Furnished With 8" x 12" Control Bracket (Supplied By Others)	760
K-461A	Disposal Collar Welded Into Sink Bowl And Furnished With 14" x 16" Control Bracket (Supplied By Others)	808
K-472	Special Faucet Hole Location	115 ea.
K-495	Turn Down Backsplash (Incl. 2 Brackets. See K-397 For Add'l Sets)	158
K-508A	Special Modification Charge	242
K-550	Stainless Steel Tubular Rack Storage	190 lin. ft.
DTA-40	Drain Hole (For Sorting Table)	130

DTA-45	Scrap Trough Welded To Dump Sink - Min. Scrap Trough Length Is 3'. Max. Length Is 8'. For 20" x 20" x 8" Bowl Spec-Line Soil S30 Series Only. - Consult Factory For Trough Lengths Exceeding 8 Feet	\$345 lin. ft.
DTA-46	Inside Mitered Corner	512
DTA-66	Provision For Dishlanding On Straight Soil Table (Min 4')	250 /lin. Ft.
DTA-70	Install Booster Heater Brackets (Brackets By Others)	161
DTA-72	Provision For Side Loader	1049
DTA-75	Provision For Limit Switch (Limit Switch By Others)	184
DTA-76	Move Prerinse Sink To Conform To Dishmachine Requirements. Please Specify Machine When Placing Order	N/C
DTA-78	Notch In Backsplash Return To Clear Handle Please Specify Machine When Placing Order	138
DTA-81	S/S Welded Leg Assembly with S/S Feet	294 /bowl
DTA-82	15" x 20" x 8" Undercounter Dump Sink	3426 /bowl
DTA-84	Simple Pass-Thru (Specify Wall Thickness - Min. Length 36")	610 /Ft.
DTA-87	Pass-Thru Wall Frame (Specify Wall Thickness - Min. Length 36")	349 /lin. Ft.
DTA-95	Install Scrapper Top	1686
DTA-96	Install Trough Collector	2075
DTA-99A	16" x 20" x 12" Sink Bowls	1304 /bowl
DTA-99B	20" x 20" x 12" Sink Bowls	1400 /bowl
DTA-99C	10" x 14" x 5" Dump Sink	1115 /bowl
DTA-99D	18" x 24" x 14" Sink	1530 /bowl
DTA-99E	24" x 24" x 14" Sink	1630 /bowl
DTA-106	Mirror Highlight To Dishtable Upgrade	402

## ACCESSORIES

K-4	Lever Drain Bracket	\$116
K-5	Twist Handle Operated Drain	252
K-15	Twist Handle Operated Drain With Overflow	447
K-397	Wall Brackets (2 Each. Brackets Included With K-495)	77 /set
K-455C	Stainless Steel Sink Cover 16" x 20"	449
K-455E	Stainless Steel Sink Cover 20" x 20"	449
K-457	Replacement Rubber Scrap Block (See K-456 For Install Cost)	113 ea.
K-475	Replacement S/S Leg With Stainless Steel Bullet Foot	65 ea.
K-478	Replacement Stainless Steel Bullet Foot	26 ea.
K-488	Flanged S/S Bullet Foot	55 ea.
K-550	Stainless Steel Tubular Rack Storage	190 /lin. Ft.
K-610	Perforated Stainless Steel Sink Grid (Specify Bowl Size)	672 ea.
K-700D	12" High Removable Side Splash For Dishtables (Specify Model)	435 ea.
DTA-53	SPEC-LINE Heavy Duty Prerinse Faucet	823
DTA-51	Pre-Rinse Slide Bar for 18" x 24" Fab. Sink Bowls	425

DTA-52	Pre-Rinse Slide Bar for 24" x 24" Fab. Sink Bowls	\$505
DTA-55	Column Notch (Includes Splash)	692
DTA-56	Add'l Length On 59" Side Of Corner Or Straight Tables	196 /lin. Ft.
DTA-58	Pre-Rinse Basket w/ Slide Bar for 18" x 24" Fab. Sink Bowls	750
DTA-59	Pre-Rinse Basket w/ Slide Bar for 24" x 24" Fab. Sink Bowls	853
DTA-60	Prerinse Slide Bar for 20" x 20" Fab. Sink Bowls	337
DTA-62	Prerinse Basket For 20" x 20" Deep Drawn Bowls	661
DTA-63	Prerinse Slide Bar For 20" x 20" Deep Drawn Bowls	337
DTA-64	Prerinse Slide Bar For 16" x 20" Fab. Sink Bowls	290
DTA-65	Prerinse Slide Bar For 16" x 20" Deep Drawn Bowls	290
DTA-67	Stainless Steel Rear Cross-Bracing (Factory Installed Only)	32 /lin. Ft.
DTA-69	Prerinse Basket For 16" x 20" Deep Drawn Bowls	629
DTA-100	Prerinse Basket with Slide Bar for 20" x 20" Fab. Sink Bowls	588
DTA-125	Prerinse Basket with Slide Bar for 16" x 20" Fab. Sink Bowls	512
DTA-125A	Prerinse Scrap Basket For DTA-82 Undermount Dump Sink	686



# Dishtables

## Dishtable Faucets & Accessories

 = Ships via UPS

### SPEC-LINE EXTRA HEAVY DUTY 14" Splash Mounted Swing Spout Faucet



8" O.C.

**K-105 \$395**   
T&S Equivalent Model # B231

 Splash Mounted  
Prerinse Faucet

**K-116 \$1142** 

 12" Add-A-Faucet

**K-117-TS \$501**

(Fits K-116 Only) 



### Prerinse Faucets

Prerinse Features:

- 8" O.C.
- Wall Bracket
- Continuous Spray Ring
- Heavy Duty Chrome Plated Spring

SPEC-LINE  
HEAVY DUTY  
Splash Mounted

**DTA-53 \$823** 

T&S Equivalent  
Model # B133-B

12" Add-A-Faucet

**K-117 \$322**

(Fits DTA-53 Only)

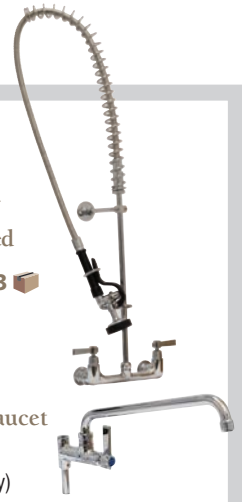

### Table Mounted SORTING SHELVES



Mounts to backsplash and end roll of dishtable  
(D, G and U-shaped Dishtables only)

Shelf Shipped Separate From Table To Reduce Freight  
Costs And Chance Of Shipping Damage.



New Versatile Design allows for  
Different Glass Rack Applications

- Drip Tubes For Water Drainage
- 14 Gauge End Plates
- 18 Gauge, 1 5/8" Tubes

**DTA-79 \$436 /lin. Ft.**



- Drip Tubes For Water Drainage
- 14 Gauge End Plates & Base
- 18 Gauge, 1 5/8" Tube

**DTA-79S \$554 /lin. Ft.**







### STAINLESS STEEL UNDERSHELVES

Additional Storage  
Shelving Is Reversible (Left Or Right)



Size Undershell To Be At Least  
6" Shorter Than Dishtable.

Now With Stainless Steel Legs!

Length	Model #	Price	Approx. Wt.	Approx. Cubes
18"	 <b>DTA-SS-18</b>	<b>\$410</b>	11 lbs.	1
24"	 <b>DTA-SS-24</b>	<b>469</b>	13 lbs.	1
30"	 <b>DTA-SS-30</b>	<b>495</b>	15 lbs.	1
42"	 <b>DTA-SS-42</b>	<b>528</b>	20 lbs.	2
54"	 <b>DTA-SS-54</b>	<b>601</b>	23 lbs.	2
66"	 <b>DTA-SS-66</b>	<b>677</b>	30 lbs.	3
78"	<b>DTA-SS-78</b>	<b>718</b>	35 lbs.	3
90"	<b>DTA-SS-90</b>	<b>767</b>	39 lbs.	4
102"	<b>DTA-SS-102</b>	<b>869</b>	45 lbs.	5
114"	<b>DTA-SS-114</b>	<b>905</b>	50 lbs.	5
126"	<b>DTA-SS-126</b>	<b>1068</b>	55 lbs.	6
138"	<b>DTA-SS-138</b>	<b>1113</b>	59 lbs.	6

### SORTING SHELVES

#### Traditional Design











#### KD Tubular Design





FOR TABLE MOUNTED, ADD **DTA-88 \$810**

Length	Model #	Racks	Price	Approx. Wt.	Approx. Cubes	Length	Model #	Racks	Price	Approx. Wt.	Approx. Cubes
22"	 <b>DT-6R-11</b>	1	<b>\$1183</b>	20 lbs.	1	22"	 <b>DT-6R-21</b>	1	<b>\$881</b>	15 lbs.	1
42"	 <b>DT-6R-12</b>	2	<b>1265</b>	30 lbs.	2	42"	 <b>DT-6R-22</b>	2	<b>993</b>	23 lbs.	2
62"	 <b>DT-6R-13</b>	3	<b>1336</b>	40 lbs.	4	62"	 <b>DT-6R-23</b>	3	<b>1059</b>	30 lbs.	4
82"	<b>DT-6R-14</b>	4	<b>1417</b>	50 lbs.	5	82"	 <b>DT-6R-24</b>	4	<b>1125</b>	38 lbs.	5

### SORTING TABLES

16 Gauge 304 Stainless Steel • 3" Raised Edge  
**STAINLESS STEEL CROSS BRACING ON ALL SIDES**

#### Standard

Model #	Price	Size	Approx. Wt.	Approx. Cubes
<b>SR-48</b>	<b>\$1926</b>	48" x 30"	84 lbs.	12
<b>SR-60</b>	<b>2038</b>	60" x 30"	98 lbs.	15
<b>SR-72</b>	<b>2151</b>	72" x 30"	109 lbs.	18
<b>SR-96</b>	<b>2406</b>	96" x 30"	143 lbs.	21





Shown With  
Optional Casters

#### 10 1/2" Backsplash

Model #	Price	Size	Approx. Wt.	Approx. Cubes
<b>BSR-48</b>	<b>\$1948</b>	48" x 30"	88 lbs.	12
<b>BSR-60</b>	<b>2052</b>	60" x 30"	103 lbs.	15
<b>BSR-72</b>	<b>2164</b>	72" x 30"	115 lbs.	18
<b>BSR-96</b>	<b>2487</b>	96" x 30"	150 lbs.	21



-  **TA-255** Super Heavy Duty Casters ..... **\$513**
- DTA-40** Drain Hole ..... **130**

 **WARNING:** Faucets on this page may contain a chemical known to the State of California to cause cancer, birth defects or other reproductive harm.



# Underbar Basics™

## Featuring New Extended Widths!

Sinks, Blender Stations, Drainboards & Liquor Racks now have a new flush design for a clean, linear appearance when adding SRK Speed Rails.



### Features and Benefits

- 18", 21", 23" & 26" Widths
- 4" Backsplash
- All Units Come with 4 Galvanized Legs w/ Adjustable Plastic Bullet Feet
- Selected Models Feature Adjustable Galvanized Cross-Bracing (Front to Back)
- Embossed & Seamless Drainboards (Where Applies)
- Blender Stations Include Hidden Duplex Electrical Outlet





# UNDERBAR DROP-INS



## Drop-In Ice Bins, Water Stations & Hand Sinks

### DROP-IN WATER STATIONS

Includes K-54 Deck Mount Faucet With "Push-Back" Acrylic Lever Arm

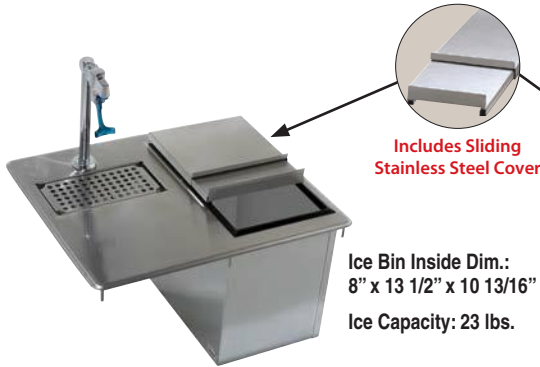

Ice Bin Inside Dim.:  
8" x 13 1/2" x 10 13/16"  
Ice Capacity: 23 lbs.



Ice Bin Inside Dim.:  
13 1/2" x 18 3/4" x 10 13/16"  
Ice Capacity: 50 lbs.



Acrylic  
Lever Arm

### Underbar Basics™

For Custom Cut-Out Use  
Model # TA-34 \$242



Overall Size:  
12" x 14"

#### D-24-WSIBL \$1303

Removable Grate Covers Drip Pan  
13" Deep Insulated Ice Bin w/ S/S Steel Cover  
1" IPS Drain  
Outside Dim. 21" x 18"  
Cut-Out Size: 20 5/8" x 15 1/4"  
30 lbs. 5 cu. Ft.

#### D-24-WSIBL2 \$1565

Removable Grate Covers Drip Pan  
13" Deep Insulated Ice Bin w/ S/S Steel Cover  
1" IPS Drain  
Outside Dim.: 18" x 21"  
Cut-Out Size: 15 1/4" x 20 5/8"  
47 lbs. 5 cu. Ft.

#### DI-1-9 \$952

Removable Electro-Polished  
Stainless Steel Grill  
1 1/2" IPS Basket Drain  
Cut-Out Size: 11 1/4" x 13 1/4"  
15 lbs. 3 cu. Ft.

### DROP-IN BAR HAND SINKS

Featuring Deep Drawn Sink Bowls



Overall Size:  
13" x 19"

SPACE SAVER



Overall Size:  
12" x 14"



Hand Sink Bowl Size:  
9" x 9" x 4"  
Ice Bin Inside Dim.:  
8" x 13 1/2" x 10 13/16"  
Ice Capacity: 23 lbs.

Includes  
Sliding  
Stainless Steel  
Cover

#### DI-1-5 \$486

K-52 Deck Mounted Faucet  
1 1/2" IPS Basket Drain  
Cut-Out Size: 12 1/4" x 18 1/4"  
20 Gauge Stainless Steel  
12 lbs. 2 cu. Ft.

#### DI-1-25 \$602

K-52 Deck Mounted Faucet  
1 1/2" IPS Basket Drain  
Cut-Out Size: 11 1/4" x 13 1/4"  
20 Gauge Stainless Steel  
8 lbs. 2 cu. Ft.

#### D-24-SIBL \$1396

K-51 Deck Mounted Faucet  
Insulated Ice Bin w/ S/S Cover  
1" IPS Drain In Ice Bin  
Outside Dim.: 21" x 18"  
Cut-Out Size: 20 5/8" x 15 1/4"  
Factory Installed Only  
20 Gauge Galvanized Steel  
30 lbs. 5 cu. Ft.

For Our Full Line Of Drop-in Sinks, See pages 3-5

## ACCESSORIES & MODIFICATIONS

### Replacement Sliding Stainless Steel Covers

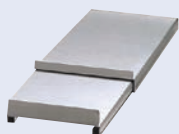

D-12  
Shown

Model #	Price	For Use With:
D-12	\$94	D-12-IBL, D-24-WSIBL, D-24-WSIBL2, D-24-SIBL
D-24	108	D-24-IBL, D-24-IBL-7
D-24V	121	D-24-IBL, D-24-IBL-7
D-30	153	Units oriented with 18" dimension left-to-right D-30-IBL, D-30-IBL-7
D-36	174	D-36-IBL, D-36-IBL-7

Cover designed to open front-to-rear, with 18" ice bin dimension front-to-rear.  
(D-24-WSIBL2 opens left to right when installed with 21" front-to-rear)



### Add Wrist Handles

K-316-LU  
\$109



### 6" Deck Mounted Faucet

K-51 \$430  
4" O.C.



Acrylic  
Lever  
Arm

### Water Filler Faucets

K-54 8-1/4" High \$446  
K-54A 12" High \$549  
K-54OMIT -\$385  
Omit K-54 Faucet



3 1/2" Gooseneck  
Deck Mounted Faucet  
K-52 \$210



# UNDERBAR DROP-INS

## Drop-In Ice Bins, Bar Sinks & Drain Pans

### Underbar Basics™

- Rubber Thermal Breaker Reduces Condensation
- Optional 7-Circuit Cold Plate Sealed Into The Bottom

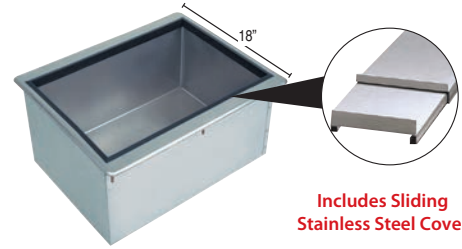

For Replacement Sliding Stainless Steel Covers, See Page 90.

## DROP-IN ICE BINS

11" Deep Insulated Ice Bin w/ Sliding Stainless Steel Cover

Model #	Price	Overall Length	Cut Out Size W x L	Ice Capacity	Approx. Weight	Approx. Cu. Ft.
D-12-IBL	\$1096	12"	15 1/4" x 9 5/8"	23 lbs.	22 lbs.	3
D-24-IBL	1194	21"	15 1/4" x 20 3/8"	50 lbs.	39 lbs.	5
D-30-IBL	1230	27"	15 1/4" x 26 3/8"	62 lbs.	62 lbs.	8
D-36-IBL	1374	33"	15 1/4" x 32 3/8"	75 lbs.	67 lbs.	9
w/ 7-CIRCUIT COLD PLATE						
D-24-IBL-7	2802	21"	15 1/4" x 20 3/8"	50 lbs.	84 lbs.	9
D-30-IBL-7	2767	27"	15 1/4" x 26 3/8"	62 lbs.	107 lbs.	13
D-36-IBL-7	2932	33"	15 1/4" x 32 3/8"	75 lbs.	113 lbs.	15

## DROP-IN BAR SINKS

Optional Built-in Embossed Drainboard

- 10" x 14" x 10" Sink Bowls
- 9" High Overflow Pipe(s) w/ 1 1/2" IPS Drain(s)
- 4" O.C. Deck Mounted Swing Faucet
- 4" O.C. Deck Mounted Faucet

Model #	Price	# of Bowls	# of Drbds.	Drbd. Size	Drbd. Location	Outside Dim. W x L	Cut Out Size W x L	Approx. Weight	Approx. Cu. Ft.
DBS-1	\$847	1	0	N/A	N/A	13" x 19"	12 1/4" x 18 1/4"	21 lbs.	3
DBS-2	951	2	0	N/A	N/A	25 1/2" x 19"	24 3/4" x 18 1/4"	26 lbs.	4
DBS-3	1145	3	0	N/A	N/A	38" x 19"	37 1/4" x 18 1/4"	42 lbs.	9
DBS-43L	1725	3	1	12"	Right	21 1/8" x 48 5/16"	17" x 47"	88 lbs.	10
DBS-43R	1725	3	1	12"	Left	21 1/8" x 48 5/16"	17" x 47"	88 lbs.	10
DBS-53C	1877	3	2	12"	Left & Right	21 1/8" x 60 5/16"	17" x 59"	100 lbs.	21
DBS-63C	1961	3	2	18"	Left & Right	21 1/8" x 72 5/16"	17" x 71"	110 lbs.	24

L and R Indicate Sink Location. C Indicates Sink is Centered.



DBS-1

DBS-53C shown

## 18" WIDE COUNTERTOP DRAIN PAN

- Removable Drip Tray
- Stainless Steel Top
- 1/2" NPT Drain

**CUSTOM SIZES AVAILABLE**  
Consult Factory For Details

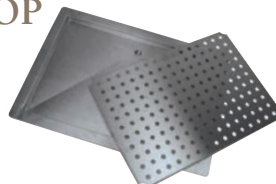

Model #	Price	Size W x L	Cut Out Size	Approx. Weight	Approx. Cu. Ft.
DP-1818	\$781	18" x 18"	15 3/4" x 15 3/4"	18 lbs.	2
DP-1824	798	18" x 24"	15 3/4" x 21 3/4"	23 lbs.	2
DP-1830	816	18" x 30"	15 3/4" x 27 3/4"	28 lbs.	3
DP-1836	844	18" x 36"	15 3/4" x 33 3/4"	33 lbs.	3
DP-1842	907	18" x 42"	15 3/4" x 39 3/4"	38 lbs.	4
DP-1848	978	18" x 48"	15 3/4" x 45 3/4"	43 lbs.	4

## BAR DRINK RAILS

- Type 300 Stainless Steel
- 8" Wide (Front To Back) x 3/4" Deep
- Perforated Removable Grate Allows For Easy Cleaning
- 1" Drain On Right Side
- Designed To Secure To Underside Of Wood Substrate



Model #	Price	Size W x L	Approx. Weight	Approx. Cu. Ft.
DRKR-12	\$283	8" x 12"	10 lbs.	2
DRKR-18	315	8" x 18"	15 lbs.	2
DRKR-24	331	8" x 24"	20 lbs.	2
DRKR-30	381	8" x 30"	25 lbs.	2
DRKR-36	423	8" x 36"	30 lbs.	3
DRKR-42	478	8" x 42"	35 lbs.	3
DRKR-48	538	8" x 48"	40 lbs.	3

### OPTIONS

- DRKC-45-IC  
45° Inside Corner
- DRKC-45-OC  
45° Outside Corner  
**\$528 ea.**
- DRKC-90-IC  
90° Inside Corner
- DRKC-90-OC  
90° Outside Corner  
**\$528 ea.**

## COUNTERTOP GLASS RINSER

Rinses away any impurities that might be in the glass!

- Mounts Easily to countertop or bar equipment
- Brushed Stainless Steel
- Water Rinsing And Glass Actuator By Pushing Down On Glass
- Threaded Drain For 1/2" Drain Hose



**FACTORY INSTALLED ONLY**

Model #	Price	Size W x L x H	Approx. Wt	Approx. Cu. Ft.
SU-16	\$697	6 3/8" x 6 3/8" x 3/4"	7 lbs.	1

## UNDERCOUNTER GLASS RINSER

Rinses away any impurities that might be in the glass!

- Mounts Easily to Underside Of Wood Substrate
- Brushed Stainless Steel
- Retrofit any liquid dispense station
- Water Rinsing And Glass Actuator By Pushing Down On Glass
- Threaded Drain For 1/2" Drain Hose



Model #	Price	O.A. W x L x H	Rinsing Size W x L x H	Approx. Wt	Approx. Cu. Ft.
SU-16UM	\$924	6 3/8" x 11 3/8" x 1"	6-3/8" x 6-3/8" x 1"	8 lbs.	1

# BAR HAND SINKS

## Free Standing Bar Hand/Dump Sinks

Underbar **Basics™**



### BAR HAND SINKS

Bowl Size: 10" x 14" x 10" • 29" Working Height • 4" High Backsplash  
Includes 1-1/2" IPS Drain & Galvanized Legs w/ Adjustable Galvanized Side Cross-Bracing & Adjustable Plastic Bullet Feet  
Add **SU-10A** For Stainless Steel Leg & Stainless Steel Bullet Foot Upgrade w/ Front-to-Back Cross-Bracing **\$230**



#### 18" Wide Units

- 4" O.C. Splash Mounted Swing Spout Faucet

Model #	Price	Overall Length	Approx. Weight	Approx. Cu. Ft.
<b>SL-HS-12</b>	<b>\$799</b>	12"	31 lbs.	5
<b>SL-HS-15</b>	<b>846</b>	15"	34 lbs.	6



#### 21" Wide Units

- 4" O.C. Deck Mounted Swing Spout Faucet
- Rear Deck For Extra Storage

Model #	Price	Overall Length	Approx. Weight	Approx. Cu. Ft.
<b>CR-HS-12</b>	<b>\$832</b>	12"	32 lbs.	6
<b>CR-HS-15</b>	<b>875</b>	15"	35 lbs.	6

## HAND SINKS W/ BUILT-IN SOAP & TOWEL DISPENSERS

Bowl & Faucet • 29" Working Height • 4" High Backsplash  
Includes 1 1/2" IPS Basket Drain & Galvanized Legs w/ Adjustable Galvanized Side Cross-Bracing & Adjustable Plastic Bullet Feet  
Add **SU-10C** For Stainless Steel Leg & Stainless Steel Bullet Foot Upgrade w/ Front-to-Back Cross-Bracing **\$230**



#### 21" Wide Standard Units

- 4" O.C. Deck Mounted Swing Spout Faucet
- Rear Deck For Extra Storage

Model #	Price	Overall Length	Approx. Weight	Approx. Cu. Ft.
<b>SC-12-TS</b>	<b>\$1168</b>	12"	45 lbs.	4
<b>SC-15-TS</b>	<b>1195</b>	15"	49 lbs.	4



#### 21" Wide Side Splash Units

- 4" O.C. Deck Mounted Swing Spout Faucet
- 4" High Stainless Steel Side Splashes
- Rear Deck For Extra Storage

Model #	Price	Overall Length	Approx. Weight	Approx. Cu. Ft.
<b>SC-12-TS-S</b>	<b>\$1382</b>	12"	50 lbs.	4
<b>SC-15-TS-S</b>	<b>1418</b>	15"	54 lbs.	4

**18" Wide Units Available - Consult Factory**

## HAND SINK ACCESSORIES & MODIFICATIONS



#### Add Wrist Handles

**K-316-LU \$109**  
For Deck & Splash Mount Faucets



#### Replacement Deck Mount Soap Dispenser

**K-12 \$137**



#### Chrome Towel Ring

**A-15 \$96** Packed Loose



#### Replacement 6" Splash Mount Faucet

**K-125 \$281**  
4" O.C. 6" Spout

#### Add A Side Splash

For 18" Wide Units  
**SU-18R or L \$161**  
**SU-18RL \$325**



#### Replacement 6" Deck Mount Faucet

**K-51 \$430**  
4" O.C. 6" Spout

For 21" Wide Units  
**SU-21R or L \$175**  
**SU-21RL \$341**



#### Stainless Steel Leg Upgrade

- Includes 2 Sets of (2) S/S Legs w/ Adjustable S/S Bullet Feet & Adjustable S/S Front-to-Back Cross-Bracing
- Leg Heights Do Not Include 1 1/4" Bullet Foot Height

**SU-10A \$243** 18" Legs

**SU-10C \$243** 14" Legs

For Our Full Line Of Modifications & Accessories, See Page 112-114.

## BAR SINKS

w/ 10" x 14" x 10"

- 4" High Backsplash
- 29" working Height
- Molded Apron For Extra Durability
- Each Sink Bowl Includes an Overflow Pipe w/ 1 1/2" IPS Drain
- Galvanized Legs w/ Adjustable Galvanized Side Cross-Bracing & Adjustable Plastic Bullet Feet
- **SLB Series** Includes 1 - 4" O.C. Splash Mounted Swing Spout Faucet
- **CRB Series** Includes 1 - 4" O.C. Deck Mounted Swing Spout Faucet & Has Rear Deck For Extra Storage
- **4 Comp. Sinks** Include Two 6" Swing Spout Faucets



**SLB Series**  
18" Wide Units With  
Splash Mount Faucet



**CRB Series**  
21" Wide Units With  
Deck Mount Faucet



L And R Indicate Sink Location. C Indicates Sink Is Centered.

	SPLASH MOUNT FAUCET				DECK MOUNT FAUCET				O.A. Length	# of Drbds.	Drbd. Length	Approx. Cu. Ft.
	18" WIDE	Price	Spout Size	Approx. Wt.	21" WIDE	Price	Spout Size	Approx. Wt.				
<b>1 COMP.</b>	<b>SLB-31C</b>	<b>\$1277</b>	6"	55 lbs.	<b>CRB-31C</b>	<b>\$1409</b>	6"	55 lbs.	36"	2	12"	13
<b>2 COMP.</b>	<b>SLB-22C</b>	<b>1349</b>	6"	54 lbs.	<b>CRB-22C</b>	<b>1452</b>	6"	54 lbs.	24"	0	N/A	8
	<b>SLB-32LorR</b>	<b>1432</b>	6"	57 lbs.	<b>CRB-32LorR</b>	<b>1527</b>	6"	57 lbs.	36"	1	9"	13
	<b>SLB-42LorR</b>	<b>1468</b>	6"	62 lbs.	<b>CRB-42LorR</b>	<b>1573</b>	6"	62 lbs.	48"	1	21"	15
	<b>SLB-42C</b>	<b>1479</b>	6"	66 lbs.	<b>CRB-42C</b>	<b>1585</b>	6"	66 lbs.	48"	2	12"	15
<b>3 COMP.</b>	<b>SLB-33C</b>	<b>1547</b>	10"	65 lbs.	<b>CRB-33C</b>	<b>1653</b>	12"	65 lbs.	36"	0	N/A	13
	<b>SLB-43LorR</b>	<b>1627</b>	10"	68 lbs.	<b>CRB-43LorR</b>	<b>1740</b>	12"	68 lbs.	48"	1	9"	15
	<b>SLB-53C</b>	<b>1712</b>	10"	76 lbs.	<b>CRB-53C</b>	<b>1831</b>	12"	76 lbs.	60"	2	12"	18
	<b>SLB-63C</b>	<b>1804</b>	10"	88 lbs.	<b>CRB-63C</b>	<b>1931</b>	12"	88 lbs.	72"	2	18"	22
	<b>SLB-73C</b>	<b>2006</b>	10"	162 lbs.	<b>CRB-73C</b>	<b>2146</b>	12"	170 lbs.	84"	2	24"	39
<b>4 COMP.</b>	<b>SLB-83C</b>	<b>2193</b>	10"	183 lbs.	<b>CRB-83C</b>	<b>2353</b>	12"	191 lbs.	96"	2	30"	44
	<b>SLB-64C*</b>	<b>2130</b>	6"	92 lbs.	<b>CRB-64C*</b>	<b>2269</b>	6"	92 lbs.	72"	2	12"	22
	<b>SLB-74C*</b>	<b>2267</b>	6"	164 lbs.	<b>CRB-74C*</b>	<b>2424</b>	6"	172 lbs.	84"	2	18"	39
	<b>SLB-84C*</b>	<b>2463</b>	6"	185 lbs.	<b>CRB-84C*</b>	<b>2623</b>	6"	193 lbs.	96"	2	24"	44

\*4 Comp. Bar Sinks Include 2 - 6" Swing Spout Faucets

## BAR SINK & ICE BIN COMBO

With Removable Plastic Bottle Racks

- 4" Backsplash
- 29" Working Height
- Three or Four Compartment - 10" x 14" Bowls
- Each Sink Bowl Includes Overflow Pipe & 1-1/2" I.P.S. Drain
- Molded Apron For Extra Durability
- 24" x 15" x 8" Insulated Ice Bin; 54 lbs. Ice Capacity
- Ice Bin Includes 1" IPS Drain
- Galvanized Legs w/ Adjustable Galvanized Side Cross-Bracing & Adjustable Plastic Bullet Feet
- **SLC Series** Includes 1 - 4" O.C., 10" Splash Mounted Swing Spout Faucet
- **CRC Series** Includes 1 - 4" O.C., 12" Deck Mounted Swing Spout Faucet & Has Rear Deck For Extra Storage



SLC-83C-R

L And R Indicates Ice Bin Location.

SPLASH MOUNT FAUCET		DECK MOUNT FAUCET		O.A. Length	# of Bowls	# of Drbds.	Drbd. Length	Approx. Weight	Approx. Cu. Ft.
18" WIDE	Price	21" WIDE	Price						
<b>SLC-73C-LorR</b>	<b>\$2584</b>	<b>CRC-73C-LorR</b>	<b>\$2762</b>	84"	3	2	12"	185 lbs.	28
<b>SLC-83C-LorR</b>	<b>2679</b>	<b>CRC-83C-LorR</b>	<b>2857</b>	96"	3	2	18"	225 lbs.	32
<b>SLC-84C-LorR*</b>	<b>3001</b>	<b>CRC-84C-LorR*</b>	<b>3199</b>	96"	4	2	12"	225 lbs.	32

\*4 Comp. Bar Sinks Include 2 - 6" Swing Spout Faucets

## BAR SINK MODIFICATIONS

### Add A Side Splash

For 18" Wide Units  
**SU-18R or L** \$161  
**SU-18RL** \$325

For 21" Wide Units  
**SU-21R or L** \$175  
**SU-21RL** \$341

### Stainless Steel Leg Upgrade

- Includes 2 Sets of (2) S/S Legs w/ Adj. S/S Bullet Feet & Adj. S/S Front-to-Back Cross-Bracing
  - Leg Heights Do Not Include 1 1/4" Bullet Foot Ht.
- SU-10A** \$243  
18" Legs

For Our Full Line Of Speed Rails, See Page 97.



# ICE BINS

Ice Bins

**All Bottle Racks Must Be Removed For NSF Compliance & For Use With Optional Cover**

**Underbar Basics™**

## ICE BINS

12" or 16" Deep Insulated Ice Bins • 29" Working Height

- 4" Backsplash
- Includes Two Removable Plastic Bottle Racks
- Galvanized Legs w/ Adjustable Galvanized Side Cross-Bracing & Adjustable Plastic Bullet Feet
- **CRI Series** Has Rear Deck For Extra Storage
- Optional 7 or 10 Circuit Cold Plate Sealed Into The Bottom



**SLI Series**  
18" Wide Units

Quick Pour Bottles Not Included



**CRI Series**  
21" Wide Units

Ice Bin Depth	Overall Length	Ice Bin Capacity	18" WIDE	Price	Approx. Weight	21" WIDE	Price	Approx. Weight	Approx. Cu. Ft.
<b>12" DEEP</b>	12"	35 lbs.	<a href="#">SLI-12-12</a>	<b>\$852</b>	26 lbs.	<a href="#">CRI-12-12</a>	<b>\$928</b>	35 lbs.	6
	24"	77 lbs.	<a href="#">SLI-12-24</a>	<b>1078</b>	52 lbs.	<a href="#">CRI-12-24</a>	<b>1150</b>	61 lbs.	8
	30"	98 lbs.	<a href="#">SLI-12-30</a>	<b>1191</b>	60 lbs.	<a href="#">CRI-12-30</a>	<b>1273</b>	69 lbs.	11
	36"	119 lbs.	<a href="#">SLI-12-36</a>	<b>1303</b>	68 lbs.	<a href="#">CRI-12-36</a>	<b>1396</b>	77 lbs.	13
	42"	140 lbs.	<a href="#">SLI-12-42</a>	<b>1363</b>	72 lbs.	<a href="#">CRI-12-42</a>	<b>1454</b>	81 lbs.	13
	48"	161 lbs.	<a href="#">SLI-12-48</a>	<b>1424</b>	87 lbs.	<a href="#">CRI-12-48</a>	<b>1505</b>	96 lbs.	14
<b>16" DEEP</b>	24"	100 lbs.	<a href="#">SLI-16-24</a>	<b>1381</b>	68 lbs.	<a href="#">CRI-16-24</a>	<b>1484</b>	75 lbs.	8
	30"	127 lbs.	<a href="#">SLI-16-30</a>	<b>1537</b>	69 lbs.	<a href="#">CRI-16-30</a>	<b>1651</b>	76 lbs.	12
	36"	155 lbs.	<a href="#">SLI-16-36</a>	<b>1695</b>	70 lbs.	<a href="#">CRI-16-36</a>	<b>1817</b>	78 lbs.	17
<b>w/ 7-CIRCUIT COLD PLATE</b>									
<b>12" DEEP</b>	24"	77 lbs.	<a href="#">SLI-12-24-7</a>	<b>2211</b>	89 lbs.	<a href="#">CRI-12-24-7</a>	<b>2284</b>	98 lbs.	8
	30"	128 lbs.	<a href="#">SLI-12-30-7</a>	<b>2325</b>	97 lbs.	<a href="#">CRI-12-30-7</a>	<b>2406</b>	106 lbs.	11
	36"	149 lbs.	<a href="#">SLI-12-36-7</a>	<b>2435</b>	105 lbs.	<a href="#">CRI-12-36-7</a>	<b>2528</b>	114 lbs.	13
	42"	170 lbs.	<a href="#">SLI-12-42-7</a>	<b>2494</b>	109 lbs.	<a href="#">CRI-12-42-7</a>	<b>2585</b>	118 lbs.	13
	48"	191 lbs.	<a href="#">SLI-12-48-7</a>	<b>2557</b>	124 lbs.	<a href="#">CRI-12-48-7</a>	<b>2592</b>	133 lbs.	14
<b>16" DEEP</b>	24"	100 lbs.	<a href="#">SLI-16-24-7</a>	<b>2512</b>	105 lbs.	<a href="#">CRI-16-24-7</a>	<b>2616</b>	112 lbs.	8
	30"	127 lbs.	<a href="#">SLI-16-30-7</a>	<b>2667</b>	106 lbs.	<a href="#">CRI-16-30-7</a>	<b>2784</b>	113 lbs.	12
	36"	155 lbs.	<a href="#">SLI-16-36-7</a>	<b>2830</b>	107 lbs.	<a href="#">CRI-16-36-7</a>	<b>2950</b>	115 lbs.	17
<b>w/ 10-CIRCUIT COLD PLATE</b>									
<b>12" DEEP</b>	30"	98 lbs.	<a href="#">SLI-12-30-10</a>	<b>2910</b>	132 lbs.	<a href="#">CRI-12-30-10</a>	<b>3015</b>	141 lbs.	11
	36"	119 lbs.	<a href="#">SLI-12-36-10</a>	<b>3022</b>	140 lbs.	<a href="#">CRI-12-36-10</a>	<b>3099</b>	149 lbs.	13
	42"	140 lbs.	<a href="#">SLI-12-42-10</a>	<b>3097</b>	144 lbs.	<a href="#">CRI-12-42-10</a>	<b>3252</b>	153 lbs.	13
	48"	161 lbs.	<a href="#">SLI-12-48-10</a>	<b>3228</b>	159 lbs.	<a href="#">CRI-12-48-10</a>	<b>3370</b>	168 lbs.	14
<b>16" DEEP</b>	30"	127 lbs.	<a href="#">SLI-16-30-10</a>	<b>3333</b>	141 lbs.	<a href="#">CRI-16-30-10</a>	<b>3592</b>	148 lbs.	12
	36"	155 lbs.	<a href="#">SLI-16-36-10</a>	<b>3582</b>	142 lbs.	<a href="#">CRI-16-36-10</a>	<b>3805</b>	150 lbs.	17

## ICE BIN ACCESSORIES & MODIFICATIONS



### Sliding Stainless Steel Covers For Ice Bins

For SLI & CRI Series

<b>SSC-12</b>	For 12" Ice Bin	.....	<b>\$169</b>
<b>SSC-24</b>	For 24" Ice Bin	.....	<b>174</b>
<b>SSC-30</b>	For 30" Ice Bin	.....	<b>190</b>
<b>SSC-36</b>	For 36" Ice Bin	.....	<b>205</b>
<b>SSC-42</b>	For 42" Ice Bin	.....	<b>256</b>
<b>SSC-48</b>	For 48" Ice Bin	.....	<b>263</b>

For Older Style Ice Bins Prior to 2015

<b>SSC-23</b>	For 24" Ice Bin	.....	<b>\$217</b>
<b>SSC-29</b>	For 30" Ice Bin	.....	<b>233</b>
<b>SSC-35</b>	For 36" Ice Bin	.....	<b>248</b>



### Stainless Steel Leg Upgrade

Includes 2 Sets of (2) S/S Legs w/ Adj. S/S Bullet Feet & Adj. S/S Front-to-Back Cross-Bracing

<b>SU-10B</b>	10" legs (16" Deep Ice Bins)	.....	<b>\$243</b>
<b>SU-10C</b>	14" legs (12" Deep Ice Bins)	.....	<b>243</b>

Leg Heights Do Not Include 1 1/4" Bullet Foot Height



### Stainless Steel Ice Bin Partitions

<b>A-38</b>	8" High x 14 3/4" Wide Partition	.....	<b>122</b>
<b>A-39</b>	12" High x 14 3/4" Wide Partition	.....	<b>122</b>
<b>A-40</b>	16" High x 14 3/4" Wide Partition	.....	<b>122</b>



<b>SU-24</b>	Provision To Connect Underbar Equipment (Price Per Every Two Units)	.....	<b>140</b>
<b>SU-30</b>	Soda Chase Provision (Tip-Out) (Only For Ice Bins w/Backsplash)	.....	<b>447</b>

### ICE BIN & BOTTLE STORAGE COMBO

Featuring 12" Deep Insulated Ice Bin

- 4" Backsplash
- 29" working height
- 1 or 2 Insulated 12" Wide Bottle Rack Bins
- Includes 3-Pack Plastic Bottle Rack(s)
- Welded Partition Between Bins
- Galvanized Legs w/ Adjustable Galvanized Side Cross-Bracing & Adjustable Plastic Bullet Feet
- Two 1" I.P.S. Drains (Cold Plate Units have 1/2" I.P.S. Drain in Ice Bin Area)
- Optional 7-Circuit Cold Plate Sealed Into The Bottom

21" WIDE		L	# Of Bins	# Of Btl. Racks	Ice Bin Length	Ice Bin Capacity*	Approx. Weight	Approx. Cu. Ft.
Model #	Price							
CRCI-36L or R	\$2078	36"	2	2	24"	77/35 lbs.	82 lbs.	14
CRCI-48L or R	2320	48"	2	2	36"	119/35 lbs.	95 lbs.	14
CRCI-48LR	3005	48"	3	4	24"	35/77/35 lbs.	113 lbs.	15
w/ 7-CIRCUIT COLD PLATE								
CRCI-36L-7 or R-7	3441	36"	2	2	24"	77/35 lbs.	114 lbs.	14
CRCI-48L-7 or R-7	3684	48"	2	2	36"	119/35 lbs.	127 lbs.	14
CRCI-48LR-7	4369	48"	3	4	24"	35/77/35 lbs.	145 lbs.	15

\*Reverse Ice Bin Capacities For L or R Models. L And R Indicate Ice Bin Location On Either Right Or Left Side. LR Indicates Ice Bin Is Centered.

Quick Pour Bottles Not Included



CRCI-48L

### INSULATED BOTTLE STORAGE BIN

Featuring 12" Deep Insulated Ice Bin

- 4" Backsplash
- 29" working height
- Includes Two 3-Pack Plastic Bottle Racks
- Galvanized Legs w/ Adjustable Galvanized Side Cross-Bracing & Adjustable Plastic Bullet Feet
- 1" I.P.S. Drain

18" WIDE		21" WIDE		L	Ice Bin Capacity	Approx. Weight	Approx. Cu. Ft.
Model #	Price	Model #	Price				
SLI-12-12	\$852	CRI-12-12	\$928	12"	35 lbs.	35 lbs.	6

Quick Pour Bottles Not Included



SLI-12-12

### ICE BIN & DRAINBOARD COMBO

Featuring 10" Deep Insulated Ice Bin

- 4" Backsplash
- 29" working height
- 24" Ice Bin
- 24" Seamless & Embossed Drainboard
- Galvanized Legs w/ Adjustable Galvanized Side Cross-Bracing & Adjustable Plastic Bullet Feet
- 1" I.P.S. Drain (Cold Plate Units have 1/2" I.P.S. Drain in ice Bin Area)
- Optional 7-Circuit Cold Plate Sealed Into The Bottom

21" WIDE		L	Ice Bin Capacity	Approx. Weight	Approx. Cu. Ft.
Model #	Price				
CRW-4R	\$2167	48"	54 lbs.	72 lbs.	13
CRW-4L	2167	48"	54 lbs.	72 lbs.	13
w/ 7-CIRCUIT COLD PLATE					
CRW-4R-7	2997	48"	54 lbs.	108 lbs.	13
CRW-4L-7	2997	48"	54 lbs.	108 lbs.	13

\*L And R Indicate Ice Bin Location On Either Right Or Left Side.



CRW-4L

### PORTABLE ICE BIN

16" Deep

- Insulated Ice Bin
- 29" working height
- Stainless Steel Welded Cross-Braced Legs w/ Casters (2 w/ Brakes)
- 1" IPS Drain w/ Shut Off Valve

**EXTRA DEEP**  
For Beer Bottle Storage

18 3/4" WIDE		Size L x W x H	Ice Bin Capacity	Approx. Weight	Approx. Cu. Ft.
Model #	Price				
SCI-MIC-24	\$1394	24" x 18 3/4" x 29"	100 lbs.	120 lbs.	7
SCI-MIC-30	1455	30" x 18 3/4" x 29"	127 lbs.	130 lbs.	12
SCI-MIC-36	1562	36" x 18 3/4" x 29"	155 lbs.	145 lbs.	16



SCI-MIC-36

# BAR PASS-THRU

## Pass-Thru Workstations & Ice Bins

Underbar **Basics™**

### STANDARD DOUBLE SINK PASS-THRU WORKSTATION

With Two Deep Drawn Sink Bowls

- 29" working height
- Insulated Ice Bin w/ 7-Circuit Cold Plate Sealed Into Bottom Of Ice Bin
- Tubing Chase For Soda Gun
- Double Tier Speed Rail
- 4" O.C. Lead Free Compliant Deck Mounted Swing Spout Faucet
- Stainless Steel Welded Cross-Bracing Legs w/ Adjustable Stainless Steel Bullet Feet
- 15A - 120V GFI Duplex Outlet Hidden Beneath Shelf
- **Side Panel Models** Include Removable Perforated Top w/ Drain & Front Apron; Units Are Supported By Side Panels & Do Not Require Legs



**CR-42X36-7-R**  
(Shown with optional Wrist Handles)



**CR-44X36SP-7-L**



GFI Duplex Receptacle Hidden Beneath Blender Shelf

Model #	Price	O.A. Length	Description	Ice Capacity	Approx. Weight	Approx. Cu. Ft.
<b>CR-42X36-7-L or R</b>	<b>\$6365</b>	42"	Stainless Steel Legs	210 lbs.	233 lbs.	45
<b>SIDE PANELS WITH PERFORATED DRAINBOARD SHELF</b>						
<b>CR-44x36SP-7-L or R</b>	<b>8180</b>	44"	Side Panels w/ Perforated Drbd. Shelf	210 lbs.	425 lbs.	68

*NOTE: To determine left or right hand model, Ice Bin is either Left (L) or Right (R) of the sink from the bartender side.*

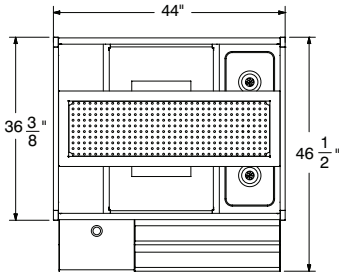

**CR-44X36SP-7-L**

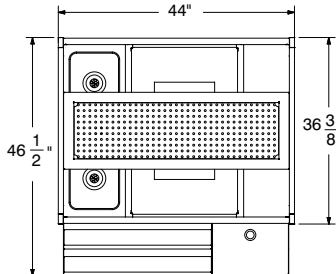

**CR-44X36SP-7-R**

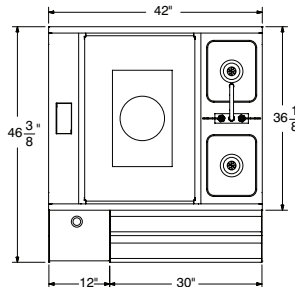

**CR-42X36-7-L**

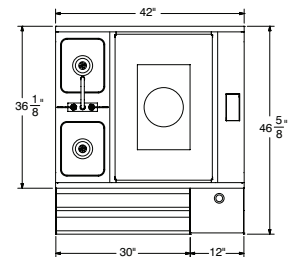

**CR-42X36-7-R**

**FOR ADDITIONAL OVERSHELVES OR GLASS RACKS, START WITH PRESTIGE PASS THRU WORK STATIONS PAGE 104**

### PASS-THRU ICE BIN 12" Deep



- 29" working height
- Insulated Ice Bin
- Stainless Steel Welded Cross-Braced Legs w/ Adjustable Stainless Steel Bullet Feet
- 210 lbs. Ice Bin Capacity
- **CRPT-2436-7** Includes 7-Circuit Cold Plate Sealed Into The Bottom Of Ice Bin

Model #	Price	Size W x L x H	Approx. Weight	Approx. Cu. Ft.
<b>CRPT-2436</b>	<b>\$2272</b>	36 1/4" x 24" x 29"	80 lbs.	13
<b>CRPT-2436-7</b>	<b>3634</b>	36 1/4" x 24" x 29"	115 lbs.	13

**ADDITIONAL SIZES AVAILABLE FOR SPECIALTY ICE BINS.**  
SU-61 Special Sizing to Reduce Length..... N/C

### SLIDING STAINLESS STEEL COVER For Pass-Thru Ice Bin



**SSC-PT \$335**

**For Full Line Of Ice Bin  
Accessories, See Page 112.**

**NSF** All Drainboards Are NSF Approved



SLD-3

- Embossed & Seamless Drainboard
- 4" Backsplash
- Galvanized Legs w/ Adjustable Galvanized Side Cross-Bracing & Adjustable Plastic Bullet Feet
- 1" IPS Drain
- CRD Series Has Rear Deck For Extra Storage

### FREE-STANDING BAR DRAINBOARDS 29" Working Height

Overall Length	18" WIDE			21" WIDE		
	Model	Price	Approx. Weight	Model	Price	Approx. Weight
12"	SLD-12	\$651	26 lbs.	CRD-12	\$726	28 lbs.
18"	SLD-18	717	29 lbs.	CRD-18	820	30 lbs.
24"	SLD-2	836	35 lbs.	CRD-2	890	39 lbs.
30"	SLD-30	886	40 lbs.	CRD-30	1008	41 lbs.
36"	SLD-3	971	42 lbs.	CRD-3	1067	47 lbs.
48"	SLD-4	1151	55 lbs.	CRD-4	1240	51 lbs.

**MAKE 24" CORNER DRAINBOARDS**  
Add to SLD-2 or CRD-2 Drainboards Only

Model #	Price	W x L
SU-1824R or L	\$211	18" x 24"
SU-2124R or L	228	21" x 24"

Add SU-40 To Prep Unit For Speed Rail Installation - \$75

### RECESSED BAR DRAINBOARDS Holds Multiple Tiers Of Glasses • 23 1/2" Working Height



SL-GS-12 Shown  
23" Wide Units



CR-GS-18 shown  
26" Wide Units

- Includes Four Galvanized Legs w/ Adjustable Galvanized Side Cross-Bracing & Adjustable Plastic Bullet Feet
- Embossed And Seamless Drainboard
- 1" IPS Drain Centered In Drainboard
- CR-GS Series Has Rear Deck For Extra Storage

Overall Length	23" WIDE			26" WIDE		
	Model	Price	Approx. Weight	Model	Price	Approx. Weight
12"	SL-GS-12	\$606	20 lbs.	CR-GS-12	\$689	20 lbs.
15"	SL-GS-15	640	22 lbs.	CR-GS-15	703	22 lbs.
18"	SL-GS-18	697	24 lbs.	CR-GS-18	755	24 lbs.
24"	SL-GS-24	778	28 lbs.	CR-GS-24	863	28 lbs.

### SPECIALTY BAR DRAINBOARDS

#### Beer Drainer

Features A 3" x 6" Rear Column For Beer Lines  
26" Working Height



CRBD-2

- 7" Backsplash
- Embossed And Seamless Drainboard
- Galvanized Legs w/ Adjustable Plastic Bullet Feet
- Adjustable Galvanized Side Cross-Bracing
- 1" IPS Drain Centered In Drainboard

#### Frozen Drink Machine Stands

10-1/2" Working Height



SCFD-18

- 14" Backsplash
- Features A Lower Working Height To Accommodate The Height Of Most Drink Machines For Underbar Use
- Beveled Front
- Drain Centered In Back Of Unit
- Galvanized Legs w/ Adjustable Plastic Bullet Feet
- Adjustable Galvanized Side Cross-Bracing

L	18" WIDE			21" WIDE		
	Model	Price	Wt.	Model	Price	Wt.
18"	SLBD-18	\$1086	32 lbs.	CRBD-18	\$1239	33 lbs.
24"	SLBD-2	1204	38 lbs.	CRBD-2	1297	42 lbs.

**SCFD-18 \$1012**  
18" x 28" x 33"  
Holds One Drink Machine  
45 lbs. 10 Cu. Ft.

**SCFD-30 \$1515**  
30" x 28" x 33"  
Holds Two Drink Machines  
80 lbs. 18 Cu. Ft.



# BLENDER STATIONS

## Blender Stations & Uni-Serv Speed Bar

Underbar **BASICS™**

### BLENDER STATIONS

Includes Four Galvanized Legs w/ Adjustable Plastic Bullet Feet  
Featuring Adjustable Galvanized Side Cross-Bracing  
All Faucets Meet Federal Lead Free Standards



All Blender Stations Include A  
15A - 120V GFI Duplex Receptacle  
Hidden Beneath Blender Shelf

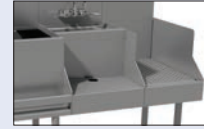

**WANT US TO CONNECT IT?**  
Add **SU-24**

Price Per Every Two Units **\$140**



### w/ Dump Sink & Faucet

- Dump Sink
- 4" Backsplash
- 15A - 120V GFI Duplex Outlet Hidden Beneath Shelf
- Recessed Step For Blenders
- Grommet Hole For Blender Power Cords
- 1" IPS Drain

- **SL-RS Series** Includes 4" O.C. Splash Mounted Swing Spout Faucet
- **CR-RS Series** Includes 4" O.C. Deck Mounted Swing Spout Faucet And Has Rear Deck For Extra Storage

**SL-RS Series**  
23" Wide Units With  
Splash Mount Faucet

**CR-RS Series**  
26" Wide Units With  
Deck Mount Faucet

Overall Length	23" WIDE	Price	Approx. Weight	Approx. Cu. Ft.	26" WIDE	Price	Approx. Weight	Approx. Cu. Ft.
12"	<b>SL-RS-12</b>	<b>\$952</b>	20 lbs.	6	<b>CR-RS-12</b>	<b>\$1022</b>	21 lbs.	6
18"	<b>SL-RS-18</b>	<b>1092</b>	23 lbs.	6	<b>CR-RS-18</b>	<b>1138</b>	23 lbs.	6



### Double Step Blender Station

- Features Two Blender Stations For High Volume Mixing Areas
- 15A - 120V GFI Duplex Outlet Hidden Beneath Shelf
- Grommet Hole For Blender Power Cords
- 4" Backsplash
- **CR-DB Series** Has Rear Deck For Extra Storage

**NOTE:**  
Blender Stations Can  
Not Accommodate  
A Speed Rail

**SL-DB Series**  
23" Wide Units

**CR-DB Series**  
26" Wide Units

Overall Length	23" WIDE	Price	Approx. Weight	Approx. Cu. Ft.	26" WIDE	Price	Approx. Weight	Approx. Cu. Ft.
12"	<b>SL-DB-12</b>	<b>\$635</b>	20 lbs.	6	<b>CR-DB-12</b>	<b>\$686</b>	21 lbs.	6
18"	<b>SL-DB-18</b>	<b>721</b>	21 lbs.	6	<b>CR-DB-18</b>	<b>744</b>	22 lbs.	6

### BLENDER STATION ACCESSORIES & MODIFICATIONS

<b>A-15</b>	Chrome Towel Ring (Packed Loose)	.....	<b>\$96</b>
<b>A-16</b>	Perforated Basket (Fits 10" x 14" x 10" Sink)	.....	<b>239</b>
<b>A-17</b>	Perforated Basket (Fits 9-1/2" x 11-1/2" x 6 Sink)	.....	<b>234</b>
<b>K-316-LU</b>	Add Wrist Handles	.....	<b>109</b>
<b>SU-10A</b>	18" Stainless Steel Leg Upgrade (Set of 4 -Includes Adjustable Front-to-Back Cross-Bracing)	.....	<b>243</b>



### Add A Liquid Waste Chute

- 5-1/2" Diameter Liquid Waste Chute
- Includes K-54 Push-Back Water Filler Faucet

**SU-36 \$833**

### UNI-SERV SPEED BAR

12" Deep Ice Bin w/ Dump Sink, Recessed Drainboard & Blender Station • 29" Working Height

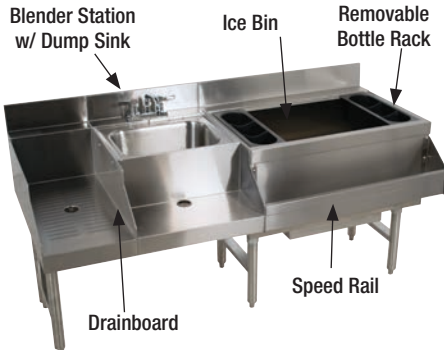

**CRU-60R Shown**

- 4" Backsplash
- 26" Front To Back
- SRK-30 - 30" Speed Rail
- 30" Insulated Ice Bin
- 98 lbs. Ice Bin Capacity
- Two Removable Plastic Bottle Racks
- Optional 7-Circuit Cold Plate Sealed Into The Bottom Of Ice Bin
- Dump Sink
- 4" O.C. Deck Mounted Swing Spout Faucet
- Recessed Drainboard for Glassware
- Dual Blender/Mixer Recess
- Galvanized Legs w/ Adjustable Plastic Bullet Feet & Adjustable Galvanized Side Cross-Bracing



15A - 120V GFI Duplex  
Receptacle Hidden  
Beneath Blender Shelf

Model #	Price	Overall Length	Approx. Weight	Approx. Cu. Ft.
<b>CRU-60L or R</b>	<b>\$3391</b>	60"	110 lbs.	23
<b>w/ 7-CIRCUIT COLD PLATE</b>				
<b>CRU-60L-7 or R-7</b>	<b>4753</b>	60"	193 lbs.	23

*L And R Indicate Ice Bin Location.*

### BEER BOX

18" Deep • 29" Working Height

- Perforated False Bottom Allows Melted Ice To Drain
- False Bottom Is Removable For Easy Cleaning
- 4" Backsplash
- Stainless Steel Legs w/ Adjustable Stainless Steel Bullet Feet
- 1" I.P.S. Drain



CRBB-48

Model #	Price	Overall Length	Ice Bin Liner Size W x L x H	Capacity of Bottled Beer	Approx. Weight	Approx. Cu. Ft.
CRBB-48	\$2229	48"	20 3/4" x 45 3/4" x 18"	12 cases	220 lbs.	14
CRBB-60	2386	60"	20 3/4" x 57 3/4" x 18"	18 cases	225 lbs.	15

### BEER BOX COVERS

Includes Two Padded Locks & Keys



*Beer Box Covers Must Be Removed During Normal Operation*

Model #	Description	Price
SU-35A	For 48" Beer Box	\$699
SU-35B	For 60" Beer Box	879

Add **SU-55** For Stainless Steel Divider - \$169 ea.

### LIQUOR DISPLAYS **NSF**

Tiered Steps & Retaining Bars Securely Display Liquor Bottles



LD-1824

### Liquor Display Rack

- Sound Deadened
- 4" Backsplash
- Galvanized Legs w/ Adjustable Plastic Bullet Feet
- Adjustable Galvanized Side Cross-Bracing
- 26" Wide Units Have Rear Deck For Extra Storage



CRLR-24

### Liquor Display Cabinet

- Stainless Steel Cabinet
- 4" Backsplash
- Stainless Steel Legs w/ Adjustable Bullet Feet

	Model #	Price	Overall Length	Approx. Bottle Capacity	Approx. Weight	Approx. Cu. Ft.
<b>23" WIDE</b>	LD-1812	\$997	12"	12	30 lbs.	15
	LD-1818	1102	18"	20	35 lbs.	20
	LD-1824	1332	24"	28	40 lbs.	30
<b>26" WIDE</b>	LD-2112	1090	12"	12	30 lbs.	15
	LD-2118	1230	18"	20	35 lbs.	20
	LD-2124	1396	24"	28	40 lbs.	30

	Model #	Price	Overall Length	Approx. Bottle Capacity	Approx. Weight	Approx. Cu. Ft.
<b>21" WIDE</b>	CRLR-12	\$1191	12"	15	35 lbs.	7
	CRLR-18	1267	18"	20	36 lbs.	10
	CRLR-24	1669	24"	30	42 lbs.	13
	CRLR-30	1728	30"	35	47 lbs.	14
	CRLR-36	1839	36"	45	50 lbs.	15

### REMOVABLE STAINLESS STEEL LIQUOR DISPLAY COVERS

Includes Padlock & Two Keys. Factory Installed Only.

#### Display Rack Cover

For LD Models Only



	Length	Model #	Price
<b>18" WIDE</b>	12"	LC-1812	\$504
	18"	LC-1818	559
	24"	LC-1824	616
<b>21" WIDE</b>	12"	LC-2112	543
	18"	LC-2118	599
	24"	LC-2124	677

#### Display Cabinet Cover

For CRLR Models Only



	Length	Model #	Price
<b>21" WIDE</b>	12"	LC-12	\$610
	18"	LC-18	660
	24"	LC-24	699
	30"	LC-30	782
	36"	LC-36	845

For Speed Rails, See Page 97.

# BAR STORAGE

## Glassware Storage

Glass Racks Not Included • Approximate Weights & Cubes Listed

## UNDERBAR STORAGE CAB

With Seamless & Embossed Drainboard Top

### Drainboard Cabinets

- 21" Width (Front to Back)
- 4" Backsplash
- 1" IPS Drain In Back Right Corner Of Top
- 3" Diameter Drain Hole In Upper Right Corner Of Back Panel
- Stainless Steel Legs w/ Adjustable Bullet Feet



**OPEN BASE**  
CRD-2B Shown



**w/ MID-SHELF**  
CRD-2BM Shown



**W/ MID-SHELF & DOOR**  
CRD-2BMD Shown

Underbar **Basics™**

Size W x L x H	OPEN BASE		2 TIER STORAGE UNIT		2 TIER STORAGE UNIT WITH HINGED DOOR		Approx. Weight	Approx. Cu. Ft.
	Model #	Price	Model #	Price	Model #	Price		
21" x 24" x 33"	CRD-2B	\$1435	CRD-2BM	\$1666	CRD-2BMD	\$1748	59 lbs.	14
21" x 30" x 33"	CRD-30B	1504	CRD-30BM	1844	CRD-30BMD	2012	99 lbs.	18
21" x 36" x 33"	CRD-3B	1672	CRD-3BM	2018	CRD-3BMD	2185	140 lbs.	20
21" x 48" x 33"	CRD-4B	1816	CRD-4BM	2162	CRD-4BMD	2306	152 lbs.	20

### 24" Glass Rack Storage Unit



CRCR-24-CT

- 21" Width (Front to Back)
- 4" Backsplash
- Holds Up To 3 Glass Racks
- Stainless Steel Glass Rack Slides
- 1" IPS Drain In Back Right Corner Of Top
- 3" Diameter Drain Hole In Upper Right Corner Of Back Panel
- Stainless Steel Legs w/ Adjustable Bullet Feet

52 lbs. 13 Cu. Ft.

**CRCR-24 \$1327**  
Flat Top - Drain Not Included  
**CRCR-24-CT \$1416**  
Corrugated Top

### Cabinet w/ Dump Sink & Waste Chute



- 21" x 18" x 33"
- Includes 1 Hinged Door
- 9" x 9" x 4" Dump Sink
- 4" O.C. Splash Mounted Swing Spout Lead Free Compliant Faucet
- 5 1/2" Diameter Waste Chute
- Stainless Steel Legs w/ Adjustable Bullet Feet

64 lbs. 15 Cu. Ft.

**CRDW-18 \$2211**

**Shown With Optional Door Lock and Wrist Handle Faucet**

## CABINET MODIFICATIONS & ACCESSORIES



**Add A Sink - \$924**  
Splash Mount Faucet Included

**SU-22A 10" x 14" x 10" Bowl**

**SU-22B 9 1/2" x 11 1/2" x 6" Bowl**

**SU-22C 9" x 9" x 4" Bowl**

**Add A Door Lock**

**SU-27 \$272**

- Includes 2 Keys



**Add A Liquid Waste Chute With Filler Faucet**

**SU-36 \$833**

- 5 1/2" Dia. Liquid Waste Chute
- Includes K-54 Push-Back Water Filler Faucet  
*(Meets Federal Lead Free Standards)*

**Add A Dipperwell Only**

**A-7 \$384**

- 5 1/2" Diameter
- 1-1/2" NPT Drain Connection
- Factory Installed. Includes TA-34 Cutout



**WANT US TO CONNECT IT?**

**Add SU-24 \$140**

Price Per Every Two Units

### STANDARD SPEED RAILS

#### Stainless Steel Speed Rails

- Keyhole Installation

SINGLE	Price	Size W x L x H	Bottle Capacity	Wt.	Cu. Ft.	DOUBLE	Price	Size W x L x H	Bottle Capacity	Wt.	Cu. Ft.
BK-15	\$100	4 1/2" x 15" x 5 1/2"	4	4 lbs.	1	DT-15	\$187	8 1/2" x 15" x 7"	8-10	7 lbs.	1
BK-2	102	4 1/2" x 24" x 5 1/2"	4-6	5 lbs.	1	DT-2	191	8 1/2" x 24" x 7"	10-12	8 lbs.	1
BK-30	112	4 1/2" x 30" x 5 1/2"	8-9	6 lbs.	1	DT-30	205	8 1/2" x 30" x 7"	16-18	10 lbs.	1
BK-3	119	4 1/2" x 36" x 5 1/2"	9-10	6 lbs.	1	DT-3	215	8 1/2" x 36" x 7"	18-20	11 lbs.	1
BK-4	143	4 1/2" x 48" x 5 1/2"	12-13	8 lbs.	1	DT-4	260	8 1/2" x 48" x 7"	24-26	18 lbs.	1

Single Tier  
BK-2 Shown



Double Tier  
DT-30 Shown



#### Black Plastic Speed Rails

- Injection Molded Black Plastic Construction
- Packed 6 Per Carton (Must Order Qty. of 6)
- Liquor Bottle Capacity = 5 Per Speed Rail

Model #	Price	Size W x L x H	Wt.	Cu. Ft.
KS-2K	\$50	4 1/8" x 23" x 5 3/8"	16 lbs.	2



Add Strap Hangers  
PR-STRAP \$43  
For KS-2K Only



### HEAVY DUTY STAINLESS STEEL SPEED RAILS

Keyhole Installation

#### Standard HD Speed Rails

SINGLE TIER  
SRK-2 Shown



DOUBLE TIER  
SRKD-18 Shown



SINGLE	Price	Size W x L x H	Cap.	DOUBLE	Price	Size W x L x H	Cap.	Wt. (lbs.)	Cu. Ft.
SRK-12	\$134	5 1/4" x 12" x 7 3/4"	3	SRKD-12	\$230	10 1/2" x 12" x 9 1/4"	6	8	1
SRK-15	138	5 1/4" x 15" x 7 3/4"	4	SRKD-15	234	10 1/2" x 15" x 9 1/4"	8	9	1
SRK-18	140	5 1/4" x 18" x 7 3/4"	4-5	SRKD-18	272	10 1/2" x 18" x 9 1/4"	8-10	10	1
SRK-2	154	5 1/4" x 24" x 7 3/4"	5-6	SRKD-2	323	10 1/2" x 24" x 9 1/4"	10-12	13	1
SRK-30	156	5 1/4" x 30" x 7 3/4"	7-8	SRKD-30	369	10 1/2" x 30" x 9 1/4"	14-16	16	1
SRK-3	159	5 1/4" x 36" x 7 3/4"	9-10	SRKD-3	383	10 1/2" x 36" x 9 1/4"	18-20	18	1
SRK-42	154	5 1/4" x 42" x 7 3/4"	11-12	SRKD-42	396	10 1/2" x 42" x 9 1/4"	22-24	20	2
SRK-4	166	5 1/4" x 48" x 7 3/4"	13-14	SRKD-4	400	10 1/2" x 48" x 9 1/4"	26-28	22	2
SRK-5	180	5 1/4" x 60" x 7 3/4"	15-18	SRKD-5	459	10 1/2" x 60" x 9 1/4"	30-36	26	2
SRK-6	200	5 1/4" x 72" x 7 3/4"	19-22	SRKD-6	505	10 1/2" x 72" x 9 1/4"	38-44	28	2
SRK-7	233	5 1/4" x 84" x 7 3/4"	23-26	SRKD-7	567	10 1/2" x 84" x 9 1/4"	46-52	30	2
SRK-8	242	5 1/4" x 96" x 7 3/4"	27-28	SRKD-8	602	10 1/2" x 96" x 9 1/4"	54-56	32	2

Make An Odd Length  
Speed Rail  
SU-41 \$68

Make Speed Rail Accommodate  
1/2 Gallon Bottles  
SU-42 \$89

#### Hang-On Style

- Removable
- Hangs On First Tier Of Any SRK Series Speed Rail
- Doubles Liquor Storage



Model #	Price	Size W x L x H	Cap.	Wt.	Cu. Ft.
SR-12H	\$181	6 1/4" x 12" x 8 1/2"	3	4 lbs.	1
SR-15H	186	6 1/4" x 15" x 8 1/2"	4	5 lbs.	1
SR-18H	193	6 1/4" x 18" x 8 1/2"	4-5	6 lbs.	1
SR-2H	197	6 1/4" x 24" x 8 1/2"	5-6	7 lbs.	1
SR-30H	210	6 1/4" x 30" x 8 1/2"	7-8	8 lbs.	1
SR-3H	222	6 1/4" x 36" x 8 1/2"	9-10	9 lbs.	1
SR-42H	230	6 1/4" x 42" x 8 1/2"	11-12	9 lbs.	2
SR-4H	234	6 1/4" x 48" x 8 1/2"	13-14	10 lbs.	2

Hang-On Style Speed Rails Are Not To Be Used  
With Any Other Manufacturer's Speed Rails

For Liquor Racks, See Page 95.





Actual Prestige Equipment Shown For Aroogas® Grille House & Sports Bar



**New Features and Benefits!**

*Perfect LINE UP Every Time!*



Removable Perforated Drainboards  
(Where Applies)

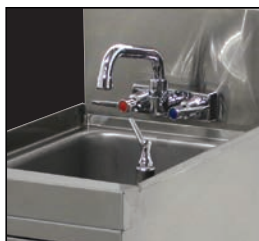

Stainless Steel Apron, Sides & Legs

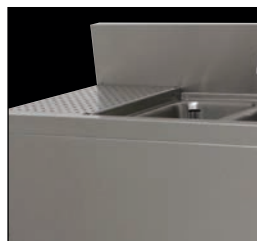

Available In Multiple Widths



7" High Backsplash with 1-3/4" Return



Adjustable Stainless Steel Side Cross-Bracing



Ice Bins w/ Cold Plate Include Soda Gun Knockout



Bar Die System Available  
(See Page 99)

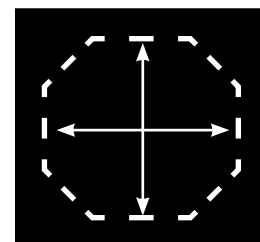

Floor Templates Available



# PRESTIGE *Signature Series*

## MODULAR BAR DIE SYSTEM Exclusively For Advance Tabco's Prestige Bar Equipment

**Bartender's Side: 20 Gauge, 302 Stainless Steel**

- Die Wall Can Be Sealed To The Floor, Eliminating Moisture In The Bar Structure.
- Recessed Equipment Outlets Allow Bar Equipment To Be Flush Against Bar Die Wall.
- GFI Outlets Set In Place (To Be Wired By Local Electrician To Meet Local Codes)
- Stainless Steel Panels Supplied Where Equipment By Others Is Located.
- Precise Engineering To Ensure An Exact Fit.
- Enclosed Casing For Beer Towers.
- Soda Gun Outlets Supplied (Location Must Be Specified).
- Cantilever System Made For Advance Tabco's Prestige Bar Equipment, Eliminating The Need For Legs.
- Pre-Defined Space For Plumbing And Drain Lines.

Bar Top And Drink Rail Can Be Fabricated From Equipment Drawings Ahead Of Time.

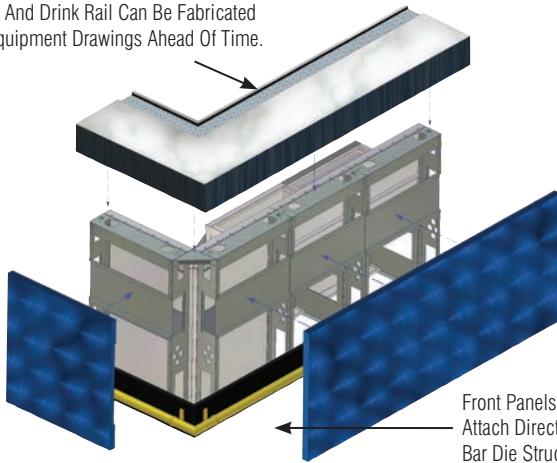



**Galvanized Bar Die Wall**  
Stainless Steel Exterior On Bar Side, Galvanized Upright Structure  
**Model # PR-BARDIE \$317 per foot**

---

**Stainless Steel Bar Die Wall**  
Stainless Steel Exterior On Bar Side, Stainless Steel Upright Structure  
**Model # PR-BARDIE-SS \$459 per foot**

For More Information, Contact Our SmartFab Department at 800-645-3166 or SmartFab@advancetabco.com.

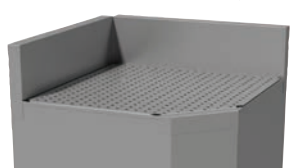
 <p><b>Flat Panel Section</b> w/ Recessed Outlet</p>	 <p><b>Ice Bin Section</b></p>	 <p><b>Cabinet Section</b></p>	<p><b>STAINLESS STEEL DRAINBOARD FILLERS</b></p> <p><b>Bolt On To Sides Of Equipment</b> Multiple Angles Available • Optional Legs (See Page 106)</p> <p>Contact SmartFab Department For Details &amp; Pricing</p> 
---	---	--	--

## BAR DIE SYSTEM ACCESSORIES & MODIFICATIONS

Factory Installed Only - Except SU-BDB-100 (Supplied Loose For In Field Positioning)



**Recessed GFI Duplex Outlet**

**SU-62C \$548**



**Cool White LED Light 1.5 Watt **

- Single Box w/ Cover Plate
- Power Supply & Wiring Not Included

**SU-BDL-CW \$211 ea.**



**Receptacle Box Only**

**SU-62F \$63**



**LED Light Power Supply **

- 100 Watts
- Handles Up to 35 Lights

**SU-BDT-100 \$237 ea.**



## Floor Templates Available

**SU-82 Call For Price**



Templates Are Printed On Paper Rolls & Are Marked For Easy Alignment



# PRESTIGE *Signature Series* MODULAR BAR DIE SYSTEM

Exclusively For Advance Tabco's Prestige Bar Equipment

Contact Our SmartFab Department For Details  
800-645-3166 or SmartFab@advancetabco.com

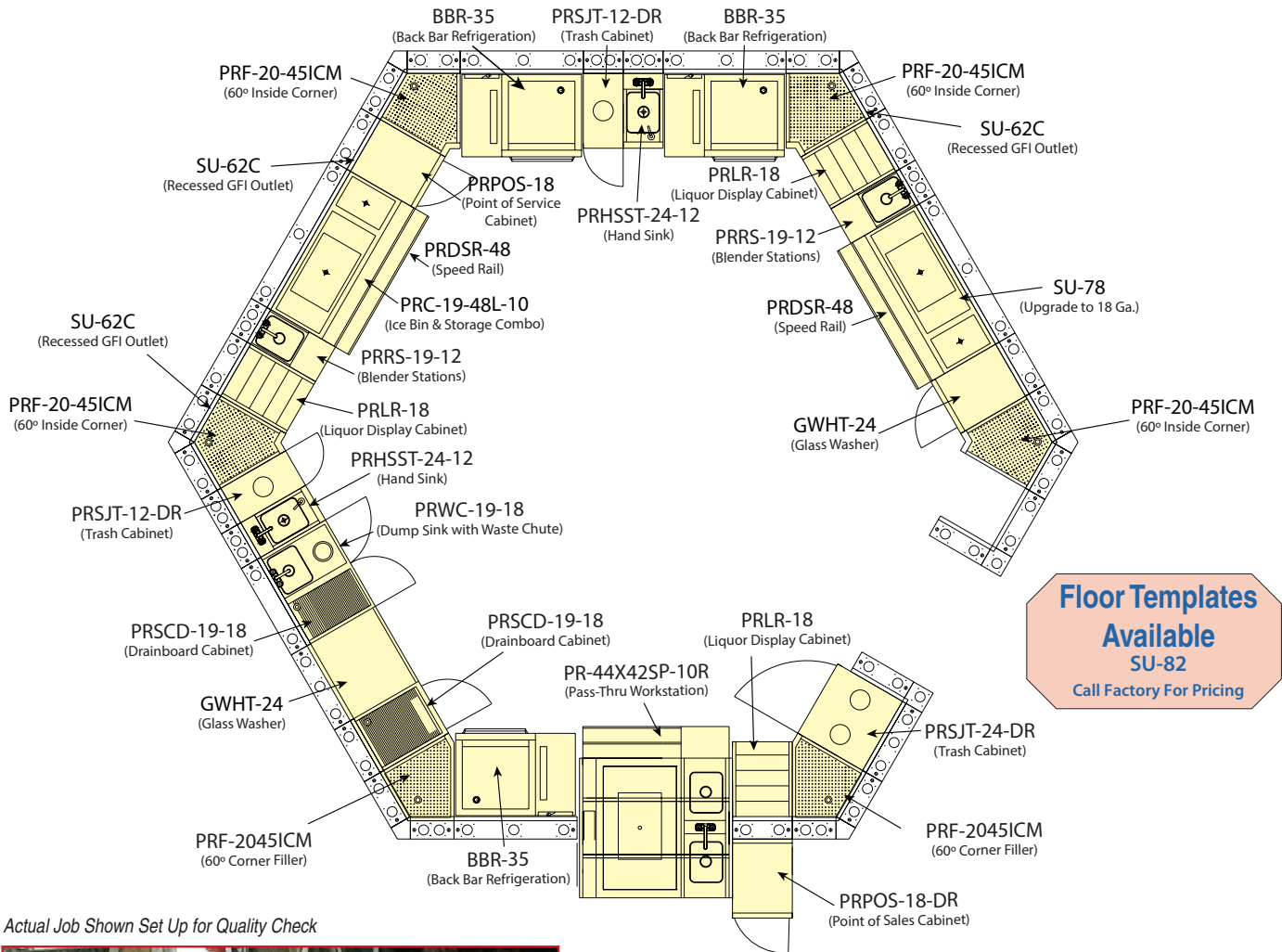

**Floor Templates Available**  
SU-82  
Call Factory For Pricing

Actual Job Shown Set Up for Quality Check



**Quality & Customer Satisfaction Is Our Top Priority!**

Our factory takes the time to set up your entire Bar Die System to ensure all equipment properly fits and matches your specifications.

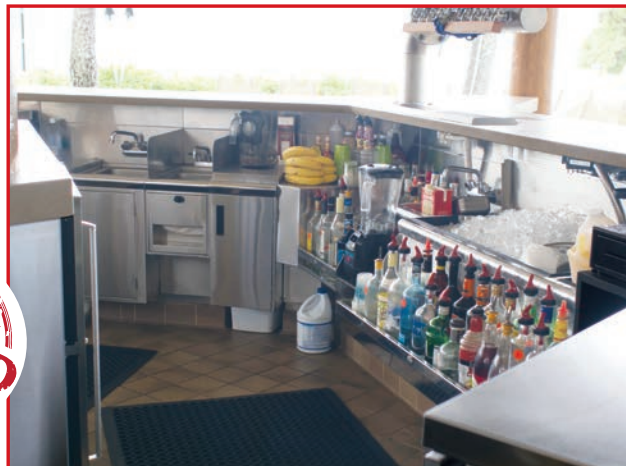

Shown with PRF-2045ICM Custom Filler & PLD-2518 Liquor Rack

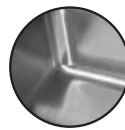

## BAR HAND SINKS

29" Working Height

All Faucets Included Meet Federal Lead Free Standards

### Standard Bar Hand Sink

- **PRHS-19 Series** Includes 4" O.C. Splash Mt. Swing Spout Faucet
- **PRHS-24 Series** Includes 4" O.C. Deck Mt. Swing Spout Faucet & Has Rear Deck For Extra Storage



All Prestige Hand Sinks Feature:

- Deep Drawn Seamless Sink Bowl
- 1 1/2" IPS, 3 1/2" Basket Drain
- 7" Backsplash
- Stainless Steel Legs w/ Stainless Steel Adjustable Bullet Feet
- Adjustable Stainless Steel Side Cross-Bracing (Except PRHSC series)

L	w/ SPLASH MOUNT FAUCET				w/ DECK MOUNT FAUCET			
	20" WIDE	Price	Wt.	Cu.	25" WIDE	Price	Wt.	Cu.
12"	<b>PRHS-19-12</b>	<b>\$1165</b>	35 lbs.	8	<b>PRHS-24-12</b>	<b>\$1216</b>	28 lbs.	8
18"	<b>PRHS-19-18</b>	<b>1182</b>	40 lbs.	9	<b>PRHS-24-18</b>	<b>1232</b>	30 lbs.	9

PRHS-19-12 Shown

### Hand Sink w/ Soap & Towel Dispensers

- Deck Mount Soap Dispenser
- C-Fold Towel Dispenser
- **PRHSST-19 Series** Includes 4" O.C. Splash Mt. Swing Spout Faucet
- **PRHSST-24 Series** Includes K-124 Deck Mt. Faucet & Has Rear Deck For Extra Storage



L	w/ SPLASH MOUNT FAUCET				w/ DECK MOUNT FAUCET			
	20" WIDE	Price	Wt.	Cu.	25" WIDE	Price	Wt.	Cu.
12"	<b>PRHSST-19-12</b>	<b>\$1545</b>	53 lbs.	8	<b>PRHSST-24-12</b>	<b>\$1593</b>	58 lbs.	8
18"	<b>PRHSST-19-18</b>	<b>1561</b>	55 lbs.	9	<b>PRHSST-24-18</b>	<b>1609</b>	60 lbs.	9

PRHSST-24-12 Shown

### Hand Sink w/ Cabinet Base

- All Stainless Steel Cabinet Base
- Hinged Cabinet Door
- **PRHSC-19 Series** Includes 4" O.C. Splash Mt. Swing Spout Faucet
- **PRHSC-24 Series** Includes K-124 Deck Mt. Faucet & Has Rear Deck For Extra Storage



L	w/ SPLASH MOUNT FAUCET				w/ DECK MOUNT FAUCET			
	20" WIDE	Price	Wt.	Cu.	25" WIDE	Price	Wt.	Cu.
12"	<b>PRHSC-19-12</b>	<b>\$1728</b>	78 lbs.	9	<b>PRHSC-24-12</b>	<b>\$1794</b>	83 lbs.	10
18"	<b>PRHSC-19-18</b>	<b>1968</b>	80 lbs.	9	<b>PRHSC-24-18</b>	<b>2016</b>	85 lbs.	10

PRHSC-19-12 Shown

## HAND SINK ACCESSORIES & MODIFICATIONS



**Add Wrist Handles**  
Available For Splash or Deck Mount Faucets

**K-316-LU \$109**



**Chrome Towel Ring**  
Packed Loose

**A-15 \$96**



**Replacement Soap Deck Mount Dispenser**

**K-12 \$137**

<b>K-123</b>	Replacement Splash Mt. Faucet	<b>\$310</b>
<b>K-124</b>	Replacement Deck Mt. Faucet	<b>310</b>
<b>SU-73</b>	Add Mirror Finish <i>Factory Install Only</i>	<b>408</b>
<b>SU-74</b>	All Stainless Steel Construction Upgrade	<b>486</b>
<b>SU-75</b>	Add Welded Stainless Steel Cross-Bracing	<b>117</b>
<b>SU-20R or L</b>	Right or Left Side Splash for 20" Wide Unit	<b>179</b>
<b>SU-20RL</b>	Right & Left Side Splash for 20" Wide Unit	<b>375</b>
<b>SU-25R or L</b>	Right or Left Side Splash for 25" Wide Unit	<b>213</b>
<b>SU-25RL</b>	Right & Left Side Splash for 25" Wide Unit	<b>402</b>

For Our Full Line Of Accessories & Modifications, See Pages 112-114.



# PRESTIGE *Signature Series* Underbar Sinks

Featuring **Deep Drawn Seamless Sink Bowls**

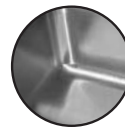

All Faucets Included Meet Federal Lead Free Standards

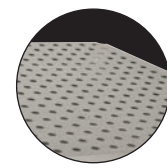

Featuring **Perforated Drainboard**

## BAR SINKS

Featuring 10" x 14" x 10" Deep Drawn Seamless Bowls & 29" Working Height

- 7" High Backsplash
- Removable Perforated Drainboard Top
- 9" Overflow Pipe w/ 1 1/2" IPS Drain Included Per Sink Bowl
- Sound Deadened
- Stainless Steel Top, Apron, Sides
- Stainless Steel Legs w/ Adjustable Stainless Steel Bullet Feet
- Adjustable Stainless Steel Side Cross-Bracing
- **PRB-19 Series** Includes 1 - 4" O.C. Splash Mounted Swing Spout Faucet
- **PRB-24 Series** Includes 1 - 4" O.C. Deck Mounted Swing Spout Faucet & Has Rear Deck For Extra Storage



**PRB-19 Series with Drainboards Shown**

20" Wide Units Include Splash Mount Faucet(s)



All Sinks Are NSF Approved



**PRB-24 Series**

25" Wide Units With Deck Mount Faucets

L And R Indicate Sink Location. C Indicates Sink Is Centered.

	w/ SPLASH MOUNT FAUCET			w/ DECK MOUNT FAUCET			O.A. Length	# of Drbds.	Drbd. Length	Approx. Weight	Approx. Cu. Ft.
	20" WIDE	Price	Spout Length	25" WIDE	Price	Spout Length					
<b>1 COMP.</b>	PRB-19-31C	\$1719	6"	PRB-24-31C	\$1815	6"	36"	2	12"	89 lbs.	12
<b>2 COMP.</b>	PRB-19-22C	1725	6"	PRB-24-22C	1775	6"	24"	N/A	N/A	89 lbs.	8
	PRB-19-32LorR	1854	6"	PRB-24-32LorR	1930	6"	36"	1	11"	89 lbs.	12
	PRB-19-42LorR	1948	6"	PRB-24-42LorR	2051	6"	48"	1	23"	105 lbs.	16
	PRB-19-42C	1948	6"	PRB-24-42C	2051	6"	48"	2	12"	105 lbs.	16
<b>3 COMP.</b>	PRB-19-33C	2002	10"	PRB-24-33C	2069	12"	36"	N/A	N/A	105 lbs.	12
	PRB-19-43LorR	2277	10"	PRB-24-43LorR	2381	12"	48"	1	11"	107 lbs.	16
	PRB-19-53LorR	2486	10"	PRB-24-53LorR	2632	12"	60"	1	23"	125 lbs.	20
	PRB-19-53C	2548	10"	PRB-24-53C	2697	12"	60"	2	12"	125 lbs.	20
	PRB-19-63C	2680	10"	PRB-24-63C	2754	12"	72"	2	18"	143 lbs.	24
	PRB-19-73C	2785	10"	PRB-24-73C	2895	12"	84"	2	24"	190 lbs.	42
	PRB-19-83C	3317	10"	PRB-24-83C	3476	12"	96"	2	30"	176 lbs.	48
<b>4 COMP.</b>	PRB-19-44C*	2498	6"	PRB-24-44C*	2584	6"	48"	N/A	N/A	107 lbs.	16
	PRB-19-64C*	3051	6"	PRB-24-64C*	3157	6"	72"	2	12"	147 lbs.	24
	PRB-19-74C*	3165	6"	PRB-24-74C*	3291	6"	84"	2	18"	163 lbs.	42
	PRB-19-84C*	3733	6"	PRB-24-84C*	3893	6"	96"	2	24"	178 lbs.	48

\*4 Comp. Bar Sinks Include 2 - 6" Swing Spout Faucets

## BAR SINK ACCESSORIES & MODIFICATIONS

<b>SU-73</b> Add Mirror Finish (Factory Install Only)	<b>\$408</b>	<b>SU-20R or L</b> Right Or Left Side Splash For PRB-19 Series	<b>\$179</b>
<b>SU-74</b> All Stainless Steel Construction Upgrade	<b>486</b>	<b>SU-20RL</b> Right & Left Side Splash For PRB-19 Series	<b>375</b>
<b>SU-75</b> Add Welded Stainless Steel Cross-Bracing	<b>117</b>	<b>SU-25R or L</b> Right Or Left Side Splash For PRB-24 Series	<b>213</b>
<b>SU-79</b> Additional Drainboard Length	<b>136 Lin Ft.</b>	<b>SU-25RL</b> Right & Left Side Splash For PRB-24 Series	<b>402</b>

**PRI & PRC Series Feature:**

- Includes Two Removable Plastic Bottle Racks
- 1 3/4" Return w/ Soda Gun Knock Out (Cold Plate Models Only)
- 7" Backsplash

- Stainless Steel Top, Apron & Sides
- Stainless Steel Legs w/ Adjustable Stainless Steel Bullet Feet
- Adjustable Stainless Steel Side Cross-Bracing
- 1" IPS Drain (Non-Cold Plate Bin); 1/2" IPS Drain (Cold Plate Bin)
- **OPTIONAL** 10-Circuit Cold Plate Sealed Into The Bottom

# PRESTIGE Signature Series Ice Bins

**NSF** All Ice Bins Are NSF Approved

**All Bottle Racks Must Be Removed For NSF Compliance & For Use With Optional Cover**

*Quick Pour Bottles Not Included*

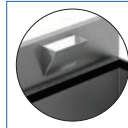

Soda Chase Provision (Tip-out)  
**SU-30 \$447**  
 Only For Ice Bins w/ Backsplash



**PRC-19-48LR**



**PRI-19-24-10**

## ICE BINS 29" Working Height

- **PRI-24 Series** Has Rear Deck For Extra Storage

Ice Bin Depth	Overall Length	Ice Bin Capacity	20" WIDE	Price	25" WIDE	Price	Approx. Weight	Approx. Cu. Ft.
<b>11" DEEP</b>	12"	32 lbs.	<b>PRI-19-12</b>	<b>\$889</b>	<b>PRI-24-12</b>	<b>\$929</b>	45 lbs.	11
	24"	70 lbs.	<b>PRI-19-24</b>	<b>1124</b>	<b>PRI-24-24</b>	<b>1183</b>	70 lbs.	11
	30"	89 lbs.	<b>PRI-19-30</b>	<b>1306</b>	<b>PRI-24-30</b>	<b>1378</b>	75 lbs.	15
	36"	108 lbs.	<b>PRI-19-36</b>	<b>1382</b>	<b>PRI-24-36</b>	<b>1495</b>	80 lbs.	15
	42"	127 lbs.	<b>PRI-19-42</b>	<b>1894</b>	<b>PRI-24-42</b>	<b>2053</b>	85 lbs.	20
	48"	146 lbs.	<b>PRI-19-48</b>	<b>1984</b>	<b>PRI-24-48</b>	<b>2223</b>	90 lbs.	20
<b>15" DEEP</b>	24"	80 lbs.	<b>PRI-19-24-XD</b>	<b>1826</b>	<b>PRI-24-24-XD</b>	<b>1876</b>	85 lbs.	20
	30"	121 lbs.	<b>PRI-19-30-XD</b>	<b>1940</b>	<b>PRI-24-30-XD</b>	<b>1998</b>	90 lbs.	27
	36"	147 lbs.	<b>PRI-19-36-XD</b>	<b>2071</b>	<b>PRI-24-36-XD</b>	<b>2134</b>	95 lbs.	37
w/ 10-CIRCUIT COLD PLATE								
<b>11" DEEP</b>	24"	70 lbs.	<b>PRI-19-24-10</b>	<b>2392</b>	<b>PRI-24-24-10</b>	<b>2416</b>	140 lbs.	18
	30"	89 lbs.	<b>PRI-19-30-10</b>	<b>2535</b>	<b>PRI-24-30-10</b>	<b>2649</b>	173 lbs.	24
	36"	108 lbs.	<b>PRI-19-36-10</b>	<b>2698</b>	<b>PRI-24-36-10</b>	<b>2763</b>	150 lbs.	24
	42"	127 lbs.	<b>PRI-19-42-10</b>	<b>2999</b>	<b>PRI-24-42-10</b>	<b>3100</b>	155 lbs.	31
	48"	146 lbs.	<b>PRI-19-48-10</b>	<b>3683</b>	<b>PRI-24-48-10</b>	<b>3924</b>	160 lbs.	31
<b>15" DEEP</b>	24"	80 lbs.	<b>PRI-19-24-10-XD</b>	<b>2881</b>	<b>PRI-24-24-10-XD</b>	<b>2891</b>	165 lbs.	20
	30"	121 lbs.	<b>PRI-19-30-10-XD</b>	<b>3084</b>	<b>PRI-24-30-10-XD</b>	<b>3164</b>	175 lbs.	27
	36"	147 lbs.	<b>PRI-19-36-10-XD</b>	<b>3226</b>	<b>PRI-24-36-10-XD</b>	<b>3835</b>	175 lbs.	27

## ICE BIN & BOTTLE STORAGE COMBO 11" Deep Insulated Ice Bin • 29" Working Height

- Welded Partition Between Bins
- **PRC-24 Series** Has Rear Deck For Extra Storage

*L And R Indicate Ice Bin Location On Either Right Or Left Side. LR Indicates Ice Bin Is Centered.*

Overall Length	# Of Independent Bins	Ice Bin Capacity	20" WIDE	Price	25" WIDE	Price	Approx. Weight	Approx. Cu. Ft.
36"	2	70/32 lbs.	<b>PRC-19-36L or R</b>	<b>\$2239</b>	<b>PRC-24-36L or R</b>	<b>\$2323</b>	105 lbs.	15
42"	2	89/32 lbs.	<b>PRC-19-42L or R</b>	<b>2397</b>	<b>PRC-24-42L or R</b>	<b>2502</b>	110 lbs.	20
48"	2	108/32 lbs.	<b>PRC-19-48L or R</b>	<b>2562</b>	<b>PRC-24-48L or R</b>	<b>2685</b>	120 lbs.	20
48"	3	32/70/32 lbs.	<b>PRC-19-48LR</b>	<b>3147</b>	<b>PRC-24-48LR</b>	<b>3280</b>	160 lbs.	22
54"	3	32/89/32 lbs.	<b>PRC-19-54LR</b>	<b>3263</b>	<b>PRC-24-54LR</b>	<b>3397</b>	165 lbs.	27
60"	3	32/108/32 lbs.	<b>PRC-19-60LR</b>	<b>3394</b>	<b>PRC-24-60LR</b>	<b>3534</b>	170 lbs.	27
w/ 10-CIRCUIT COLD PLATE								
36"	2	70/32 lbs.	<b>PRC-19-36L-10 or R-10</b>	<b>3935</b>	<b>PRC-24-36L-10 or R-10</b>	<b>4025</b>	165 lbs.	24
42"	2	89/32 lbs.	<b>PRC-19-42L-10 or R-10</b>	<b>4223</b>	<b>PRC-24-42L-10 or R-10</b>	<b>4202</b>	175 lbs.	31
48"	2	108/32 lbs.	<b>PRC-19-48L-10 or R-10</b>	<b>4259</b>	<b>PRC-24-48L-10 or R-10</b>	<b>4380</b>	185 lbs.	33
48"	3	32/70/32 lbs.	<b>PRC-19-48LR-10</b>	<b>4848</b>	<b>PRC-24-48LR-10</b>	<b>4979</b>	195 lbs.	33
54"	3	32/89/32 lbs.	<b>PRC-19-54LR-10</b>	<b>4963</b>	<b>PRC-24-54LR-10</b>	<b>5097</b>	200 lbs.	40
60"	3	32/108/32 lbs.	<b>PRC-19-60LR-10</b>	<b>5090</b>	<b>PRC-24-60LR-10</b>	<b>5235</b>	205 lbs.	40

*\*Reverse Ice Bin Capacities For L or R Models.*

**WANT TO UPGRADE? Add SU-74 For All Stainless Steel Construction - \$486**

**For Prestige Ice Bin Covers, See Page 113.**

# PRESTIGE Signature Series

## Pass-Thru Units & Service Cabinet

### PASS-THRU WORKSTATION **NSF**

With Two Deep Drawn Sink Bowls • 29" Working Height

- Stainless Steel Top & Sides
- Blender Shelf With Duplex Outlet Hidden Underneath
- Double Tier Speed Rail
- Tubing Chase For Soda Gun
- 15A - 120V GFI Duplex Outlet Hidden Beneath Shelf
- 4" O.C. Deck Mounted Lead Free Compliant Swing Spout Faucet
- Insulated Ice Bin w/ 10-Circuit Cold Plate Sealed Into Bottom

- Stainless Steel Legs w/ Adjustable Stainless Steel Bullet Feet & Welded Cross-Bracing
- **Side Panel Models** Include Removable Perforated Top w/ Drain & Front Apron; Units Are Supported By Side Panels & Do Not Require Legs



GFI Duplex Receptacle Hidden Beneath Blender Shelf



PR-44X42SP-10-L

Model #	Price	O.A. Length	Description	Ice Capacity	Approx. Weight	Approx. Cu. Ft.
PR-42X30-10-L or R	\$5252	42"	Stainless Steel Legs	70 lbs.	250 lbs.	38
PR-42X42-10-L or R	8707	42"	Stainless Steel Legs	174 lbs.	400 lbs.	58
<b>SIDE PANELS WITH PERFORATED DRAINBOARD SHELF</b>						
PR-44X30SP-10-L or R	7415	44"	Side Panels w/ Perforated Drbd. Shelf	70 lbs.	350 lbs.	59
PR-44X42SP-10-L or R	12500	44"	Side Panels w/ Perforated Drbd. Shelf	174 lbs.	575 lbs.	88

#### Dual Soda Gun Holder

- Openings for a single soda gun on each end
  - Fits Prestige® Pass-Thru Workstations Only
- SU-43 \$948**  
Factory Installed Only

*NOTE: To determine left or right hand model, Ice Bin is either Left (L) or Right (R) of the sink from the bartender side.*

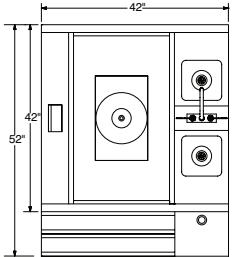

PR-42X42-10-L Shown

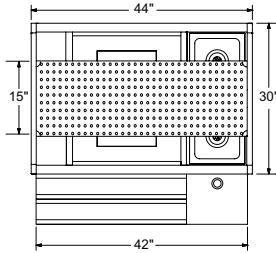

PR-44X30SP-10-L Shown

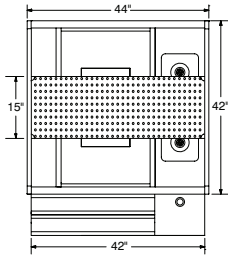

PR-44X42SP-10-L Shown

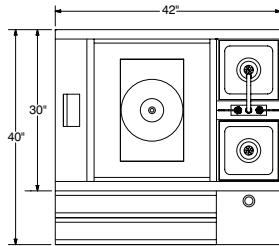

PR-42X30-10-L Shown

### OVERSHELVES FOR PASS-THRU WORKSTATIONS

(For SP Models Only - Factory Installed)

- 44" Wide x 16 3/4" Length
- Removable Perforated Pans
- Square Stainless Steel Posts
- 20 Gauge, 300 Stainless Steel

#### -G Models:

- Include Stemware Glass Rack
- 18 Gauge, 302 Stainless Steel
- Stainless Steel Shelf With Splash On Three Sides



Single Shelf  
PRSO-44-G Shown

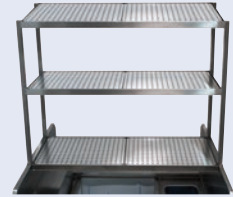

Double Shelf  
PRDO-44 Shown

Model #	Price	Description	Wt.	Cu. Ft.
PRSO-44	\$1174	Single Overshelf	65 lbs.	5
PRSO-44-G	1679	Single Overshelf w/ Stemware Glass Rack	85 lbs.	5
PRDO-44	2040	Double Overshelf	125 lbs.	17
PRDO-44-G	2776	Double Overshelf w/ Stemware Glass Rack	145 lbs.	17

### PASS-THRU ICE BINS **NSF**

11" Deep Insulated Ice Bin • 29" Working Height



Shown With Optional Speed Rail

- Stainless Steel Top, Apron, Sides & Legs w/ Adjustable Stainless Steel Bullet Feet
- Adjustable Stainless Steel Side Cross-Bracing
- PRPT-2442-10 Has 10-Circuit Cold Plate Sealed Into The Bottom

#### Sliding Stainless Steel Cover

**PRA-SSC-PT \$463**

Model #	Price	Size W x L x H	Ice Capacity	Wt.	Cu. Ft.
PRPT-2442	\$2309	42" x 24" x 29"	174 lbs.	80 lbs.	13
PRPT-2442-10	4012	42" x 24" x 29"	174 lbs.	150 lbs.	13

### BEER BOX **NSF**

18" Deep • 29" Working Height

- Perforated False Bottom Allows Melted Ice To Drain
- Removable False Bottom
- Stainless Steel Legs w/ Stainless Steel Bullet Feet
- 7" Backsplash



PRBB-48

Model #	Price	Size W x L x H	Capacity Of Bottle Beer	Wt.	Cu. Ft.
PRBB-48	\$2838	25" x 48" x 33"	12 Cases	220 lbs.	14
PRBB-60	3043	25" x 60" x 33"	18 Cases	225 lbs.	15

#### BEER BOX LOCKING COVERS

Includes Padlock & 2 Keys

SU-35C	48" Cover	\$755
SU-35D	60" Cover	935

Add Stainless Steel Dividers  
**SU-55 \$160 ea.**

*Beer Box Covers Must Be Removed During Normal Operation*

**PRD & PRGS Series Feature:**

- Removable Perforated Drainboard Top
- Stainless Steel Top, Sides & Legs w/ Adjustable Stainless Steel Bullet Feet
- Adjustable Stainless Steel Side Cross-Bracing
- 7" Backsplash
- 1" IPS Drain
- Sound Deadened

**Underbar Drainboards**

**DRAINBOARDS**

**29" Working Height**

- Stainless Steel Apron
- **PRD-24 Series** has Rear Deck For Extra Storage

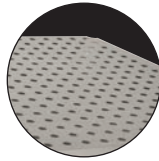

Removable Perforated Drainboard Top



All Drainboards Are NSF Approved

L	20" WIDE	Price	Approx. Weight	Approx. Cu. Ft.	25" WIDE	Price	Approx. Weight	Approx. Cu. Ft.
12"	<a href="#">PRD-19-12</a>	<b>\$836</b>	38 lbs.	8	<a href="#">PRD-24-12</a>	<b>\$896</b>	45 lbs.	10
18"	<a href="#">PRD-19-18</a>	<b>859</b>	45 lbs.	8	<a href="#">PRD-24-18</a>	<b>939</b>	52 lbs.	10
24"	<a href="#">PRD-19-24</a>	<b>928</b>	52 lbs.	8	<a href="#">PRD-24-24</a>	<b>1020</b>	59 lbs.	10
30"	<a href="#">PRD-19-30</a>	<b>1024</b>	59 lbs.	12	<a href="#">PRD-24-30</a>	<b>1086</b>	66 lbs.	14
36"	<a href="#">PRD-19-36</a>	<b>1063</b>	65 lbs.	12	<a href="#">PRD-24-36</a>	<b>1165</b>	73 lbs.	14
42"	<a href="#">PRD-19-42</a>	<b>1239</b>	70 lbs.	16	<a href="#">PRD-24-42</a>	<b>1366</b>	79 lbs.	19
48"	<a href="#">PRD-19-48</a>	<b>1332</b>	75 lbs.	16	<a href="#">PRD-24-48</a>	<b>1388</b>	86 lbs.	19



**PRD-19 Series**  
20" Wide Units



**PRD-24 Series**  
25" Wide Units

**RECESSED DRAINBOARDS**

**Holds Multiple Tiers Of Glassware • 18" Working Height**

- 14" Side Splashes
- **PRGS-24 Series** has Rear Deck For Extra Storage

L	25" WIDE	Price	Approx. Weight	Approx. Cu. Ft.	30" WIDE	Price	Approx. Weight	Approx. Cu. Ft.
12"	<a href="#">PRGS-19-12</a>	<b>\$732</b>	40 lbs.	8	<a href="#">PRGS-24-12</a>	<b>\$828</b>	45 lbs.	10
18"	<a href="#">PRGS-19-18</a>	<b>767</b>	45 lbs.	8	<a href="#">PRGS-24-18</a>	<b>830</b>	52 lbs.	10
24"	<a href="#">PRGS-19-24</a>	<b>824</b>	52 lbs.	8	<a href="#">PRGS-24-24</a>	<b>882</b>	59 lbs.	10
30"	<a href="#">PRGS-19-30</a>	<b>905</b>	59 lbs.	12	<a href="#">PRGS-24-30</a>	<b>991</b>	66 lbs.	14



**PRGS-19 Series**  
25" Wide Units



**PRGS-24 Series**  
30" Wide Units

**WANT TO UPGRADE?** Add [SU-74](#) For All Stainless Steel Construction **\$486**

**SPECIALTY DRAINBOARDS**

**Beer Drainer**

**21 1/4" Working Height**



**PRBD-19-24**

- 3" x 6" Rear Column For Beer Lines
- Removable Perforated Drainboard Top
- Stainless Steel Top, Apron, Sides & Legs w/ Adjustable Stainless Steel Bullet Feet
- Adjustable Stainless Steel Side Cross-Bracing
- 1" IPS Drain
- 14 3/4" Backsplash

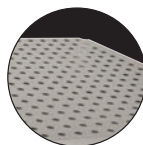

Removable Perforated Drainboard Top

L	20" WIDE	Price	Wt.	Cu. Ft.
18"	<a href="#">PRBD-19-18</a>	<b>\$1253</b>	50 lbs.	7
24"	<a href="#">PRBD-19-24</a>	<b>1271</b>	57 lbs.	8

L	25" WIDE	Price	Wt.	Cu. Ft.
18"	<a href="#">PRBD-24-18</a>	<b>\$1319</b>	57 lbs.	7
24"	<a href="#">PRBD-24-24</a>	<b>1389</b>	64 lbs.	10

**Frozen Drink Machine Stands**

**21" Working Height**



**PRFD-18**

- Lower Working Height Accommodates The Height Of Most Drink Machines For Underbar Use
- Beveled Front
- Top Pitched To 1" IPS Drain
- Stainless Steel Top, Apron, Sides & Legs w/ Adjustable Stainless Steel Bullet Feet
- Adjustable Stainless Steel Side Cross-Bracing
- 15" Backsplash

L	30" WIDE	Price	Wt.	Cu. Ft.
18"	<a href="#">PRFD-18</a>	<b>\$1204</b>	57 lbs.	14
30"	<a href="#">PRFD-30</a>	<b>1701</b>	80 lbs.	20

**POINT OF SERVICE CABINET**



**PRPOS-18-DR**  
*Shown with Optional Door Lock*



- 25" Working Height
- 11" High Backsplash & Side Splashes
- Louvered Door w/ Flush Handle
- 2" Access Hole In Work Surface For Power Cord
- Stainless Steel Top, Apron, Sides & Legs w/ Adjustable Stainless Steel Bullet Feet

**LOCK IT UP!**  
Add A Door Lock [SU-27](#) **\$272**

L	25" WIDE	Price	Wt.	Cu. Ft.
18"	<a href="#">PRPOS-18-DR</a>	<b>\$2038</b>	60 lbs.	14
24"	<a href="#">PRPOS-24-DR</a>	<b>2278</b>	150 lbs.	20



## Underbar Corner Drainboard & Fillers

All Units On This Page Feature  
A Removable Perforated  
Drainboard Top

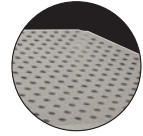

### 90° CORNER DRAINBOARD

Includes Stainless Steel Legs w/ Adjustable Stainless Steel Bullet Feet

- Free-Standing Corner Drainboard
- 7" High x 1-3/4" Thick Backsplash
- 1" I.P.S. Drain

Model #	Price	Size* (A) x (B)	Approx. Weight	Approx. Cu. Ft.
PRFD-2020	\$984	20" x 20"	68 lbs.	7
PRFD-2025	1041	20" x 25"	72 lbs.	12
PRFD-2030	1080	20" x 30"	78 lbs.	16
PRFD-2035	1169	20" x 35"	82 lbs.	16
PRFD-2520	1041	25" x 20"	69 lbs.	7
PRFD-2525	1091	25" x 25"	73 lbs.	12
PRFD-2530	1118	25" x 30"	79 lbs.	16
PRFD-2535	1226	25" x 35"	83 lbs.	16
PRFD-3020	1080	30" x 20"	78 lbs.	7
PRFD-3025	1118	30" x 25"	79 lbs.	12
PRFD-3030	1260	30" x 30"	82 lbs.	16
PRFD-3035	1320	30" x 35"	86 lbs.	16
PRFD-3520	1169	35" x 20"	82 lbs.	16
PRFD-3525	1226	35" x 25"	83 lbs.	16
PRFD-3530	1320	35" x 30"	86 lbs.	16
PRFD-3535	1393	35" x 35"	90 lbs.	16

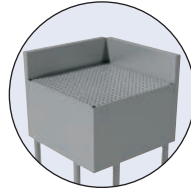

Includes Stainless Steel  
Legs w/ Adjustable  
Stainless Steel Bullet Feet

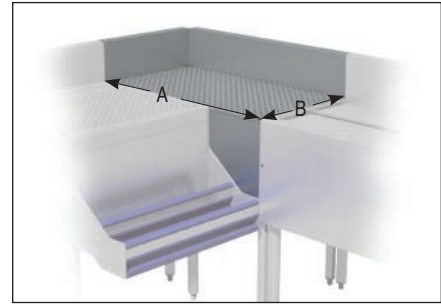

PRFD-3020

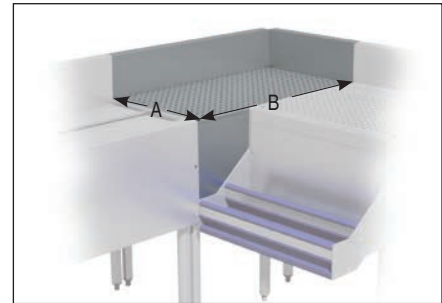

PRFD-2030

"A" represents the distance on the left side from the back wall until the front edge of the left unit.  
"B" represents the distance on the right side from the back wall until the front edge of the right unit.

### 90° CORNER FILLERS

- Must Be Bolted to Existing Line Up Equipment
- 7" High x 1-3/4" Thick Backsplash
- Available On Left or Right Side
- 1" I.P.S. Drain

#### Inside Corner

#### Outside Corner

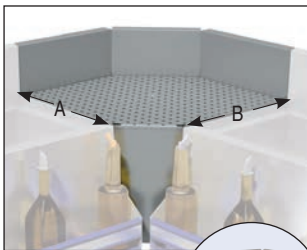

PRF-20-90IC Shown

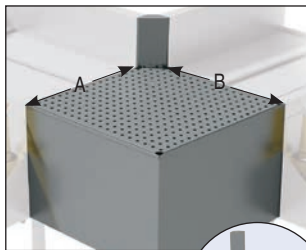
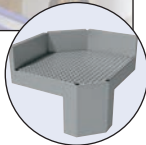

PRF-20-90OC Shown

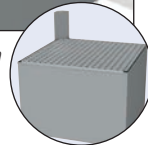

Model #	Price	Size (A) x (B)	Approx. Weight	Approx. Cu. Ft.
PRF-20-90IC or OC*	\$1052	20" x 20"	82 lbs.	16
PRF-25-90IC or OC*	1091	25" x 25"	84 lbs.	16

\* IC = Inside Corner OC = Outside Corner

### 45° CORNER FILLERS

- Must Be Bolted to Existing Line Up Equipment
- 7" High x 1-3/4" Thick Backsplash
- 1" I.P.S. Drain

#### Inside Corner

#### Outside Corner

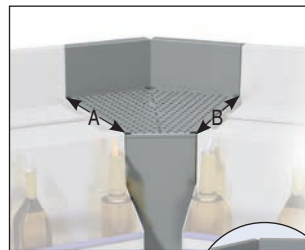

PRF-20-45IC Shown

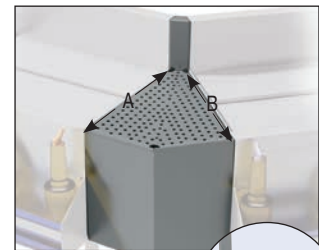
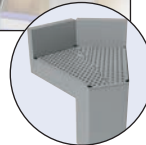

PRF-20-45OC Shown

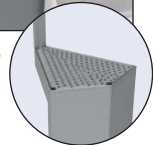

Model #	Price	Size (A) x (B)	Approx. Weight	Approx. Cu. Ft.
PRF-20-45IC or OC*	\$806	20" x 20"	82 lbs.	16
PRF-25-45IC or OC*	890	25" x 25"	84 lbs.	16

\* IC = Inside Corner OC = Outside Corner

**PLEASE NOTE: FILLERS BUILT TO ORDER & CAN NOT BE RETURNED**

**OPTIONAL LEGS & CUSTOM SIZES AVAILABLE**  
Consult Factory For Details

# Blender Stations & Uni-Serv Speed Bar

## FREE-STANDING BLENDER STATIONS

Stainless Steel Top, Apron, Sides & Legs w/ Adjustable Stainless Steel Bullet Feet  
Adjustable Stainless Steel Side Cross-bracing



15A - 120V GFI Duplex Receptacle Hidden Beneath Blender Shelf



**PRRS-19 Series**  
25" Wide Units With  
Splash Mount Faucet



**PRRS-24 Series**  
30" Wide Units With  
Deck Mount Faucet

### w/ Deep Drawn Sink

- Deep Drawn Sink
- Recessed Step w/ Grommet Hole For Blenders
- 7" Backsplash
- 3 1/2" Basket Drain w/ 1 1/2" IPS
- Sound Deadened
- **PRRS-19 Series** Includes 4" O.C. Splash Mounted Swing Spout Faucet
- **PRRS-24 Series** Includes 4" O.C. Deck Mounted Swing Spout Faucet & Has Rear Deck For Extra Storage

Overall Length	w/ SPLASH MT. FAUCET				w/ DECK MT. FAUCET			
	25" WIDE	Price	Approx. Weight	Approx. Cu. Ft.	30" WIDE	Price	Approx. Weight	Approx. Cu. Ft.
12"	<b>PRRS-19-12</b>	<b>\$1210</b>	49 lbs.	9	<b>PRRS-24-12</b>	<b>\$1327</b>	51 lbs.	9
18"	<b>PRRS-19-18</b>	<b>1298</b>	56 lbs.	9	<b>PRRS-24-18</b>	<b>1413</b>	58 lbs.	12



**PRDB-19 Series**  
25" Wide Units



**PRDB-24 Series**  
30" Wide Units

### w/ Drainboard

- Removable Perforated Drainboard Top
- Recessed Step w/ Grommet Hole For Blenders
- 7" Backsplash
- 1" IPS Drain
- Sound Deadened
- **PRDB-24 Series** Has Rear Deck For Extra Storage

Overall Length	25" WIDE				30" WIDE			
	Price	Approx. Weight	Approx. Cu. Ft.	Price	Approx. Weight	Approx. Cu. Ft.		
12"	<b>PRDB-19-12</b>	<b>\$812</b>	45 lbs.	9	<b>PRDB-24-12</b>	<b>\$899</b>	47 lbs.	9
18"	<b>PRDB-19-18</b>	<b>957</b>	50 lbs.	9	<b>PRDB-24-18</b>	<b>1054</b>	53 lbs.	12

**NOTE: Blender Stations Can Not Accommodate A Speed Rail**

### BLENDER STATION ACCESSORIES & MODIFICATIONS

- SU-73** Add Mirror Finish *Factory Install Only* ..... **\$408**
- SU-74** All Stainless Steel Construction Upgrade ..... **486**
- SU-75** Add Welded Stainless Steel Cross-Bracing ..... **117**



### Add A Liquid Waste Chute

- 5-1/2" Diameter Liquid Waste Chute
- Includes K-54 Push-Back Water Filler Faucet
- Perforated Drainboard Top Not Included

**SU-36 \$833**

## UNI-SERV SPEED BAR

Includes 30" Speed Rail • 7" Backsplash



**PRU-24-60R Shown**

- **48" Units:** 9" x 9" x 4" Deep Drawn Sink Bowl
- **60" Units:** 10" x 14" x 7" Deep Drawn Sink Bowl
- Recessed 18" Blender Station
- 3 1/2" Basket Drain
- Grommet Hole For Cord
- 30" x 11" Deep Insulated Ice Bin with Two Removable Plastic Bottle Racks
- Optional 10-Circuit Cold Plate Sealed Into The Bottom Of Ice Bin
- 1" I.P.S. Drain (1/2" I.P.S. Drain For Cold Plate Models)
- 7" Backsplash with 1 3/4" Return With Soda Gun Knock Out
- Recessed Drainboard with Removable Perforated Top with 1" I.P.S. Drain
- Stainless Steel Top, Apron, Sides & Legs with Stainless Steel Bullet Feet
- Adjustable Stainless Steel Side Cross-Bracing
- **PRU-19 Series:** 4" O.C. Splash Mounted Swing Spout Faucet
- **PRU-24 Series:** 4" O.C. Deck Mounted Swing Spout Faucet

L	25" WIDE			30" WIDE			Approx. Weight	Approx. Cu. Ft.
	O.A. Size	Price		O.A. Size	Price			
48"	<b>PRU-19-48LorR</b>	25"x48"	<b>\$3658</b>	<b>PRU-24-48LorR</b>	30"x48"	<b>\$4065</b>	135 lbs.	35
60"	<b>PRU-19-60LorR</b>	25"x60"	<b>4289</b>	<b>PRU-24-60LorR</b>	30"x60"	<b>4343</b>	135 lbs.	35
w/ 10-CIRCUIT COLD PLATE								
48"	<b>PRU-19-48L-10orR-10</b>	25"x48"	<b>4867</b>	<b>PRU-24-48L-10orR-10</b>	30"x48"	<b>5336</b>	170 lbs.	46
60"	<b>PRU-19-60L-10orR-10</b>	25"x60"	<b>5989</b>	<b>PRU-24-60L-10orR-10</b>	30"x60"	<b>6044</b>	170 lbs.	46

*L and R Indicate Ice Bin Location.*



15A - 120V GFI Duplex Receptacle Hidden Beneath Blender Shelf

# PRESTIGE Signature Series

## Underbar Cabinets

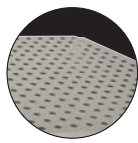

Removable Perforated Drainboard Top

**WARNING:** Equipment that includes a faucet may expose you to chemicals, including lead, that are known to the State of California to cause cancer or birth defects or other reproductive harm. For more Info, visit [www.p65warnings.ca.gov](http://www.p65warnings.ca.gov).



All Drainboards Are NSF Approved

## DRAINBOARD CABINETS

All Stainless Steel Construction

- Sturdy Base Cabinet
- Removable Perforated Drainboard Top
- Removable Hinged Doors
- 7" Backsplash
- Stainless Steel Legs w/ Adjustable Stainless Steel Bullet Feet
- 1" IPS Drain
- Sound Deadened



Open Base  
PRSCO-19-24 Shown



w/ Hinged Doors  
PRSCD-24-24 Shown

	L	25" WIDE	Price	Approx. Weight	Approx. Cu. Ft.	30" WIDE	Price	Approx. Weight	Approx. Cu. Ft.
OPEN BASE	12"	PRSCO-19-12	\$1257	48 lbs.	12	PRSCO-24-12	\$1376	55 lbs.	15
	18"	PRSCO-19-18	1372	55 lbs.	12	PRSCO-24-18	1491	62 lbs.	15
	24"	PRSCO-19-24	1526	62 lbs.	12	PRSCO-24-24	1636	69 lbs.	15
	30"	PRSCO-19-30	1814	69 lbs.	15	PRSCO-24-30	1924	76 lbs.	18
	36"	PRSCO-19-36	2091	75 lbs.	18	PRSCO-24-36	2204	82 lbs.	22
	42"	PRSCO-19-42	2357	80 lbs.	21	PRSCO-24-42	2467	90 lbs.	28
W/ HINGED DOORS	12"	PRSCD-19-12	1515	58 lbs.	12	PRSCD-24-12	1638	65 lbs.	15
	18"	PRSCD-19-18	1630	65 lbs.	12	PRSCD-24-18	1753	72 lbs.	15
	24"	PRSCD-19-24	1818	72 lbs.	12	PRSCD-24-24	1929	79 lbs.	15
	30"	PRSCD-19-30	2106	79 lbs.	15	PRSCD-24-30	2217	85 lbs.	18
	36"	PRSCD-19-36	2385	85 lbs.	18	PRSCD-24-36	2496	92 lbs.	22
	42"	PRSCD-19-42	2651	90 lbs.	21	PRSCD-24-42	2876	98 lbs.	28
48"	PRSCD-19-48	2940	95 lbs.	24	PRSCD-24-48	3047	102 lbs.	30	

20" WIDE CABINETS AVAILABLE!

LOCK IT UP!

Use 25" Wide Model # & Add SU-77 \$83

Add A Door Lock SU-27 \$272

### ADD MID-SHELF TO PRSCO SERIES \$447 /shelf

Add An "-M" After The Model Number

(For example, PRSCO-19-18 would read PRSCO-19-18-M)

#### ADD A SINK (Includes Faucet)

10" x 14" x 10"	SU-22A	\$924
9 1/2" x 11 1/2" x 6"	SU-22B	\$924
9" x 9" x 4"	SU-22C	\$924

5 1/2" Stainless Steel Open Waste Chute



A-6  
\$309

Factory Installed

5 1/2" Dipperwell with Insert and Drain



A-7  
\$384

Factory Installed. Includes TA-34 Cutout

## W/ BUILT-IN DUMP SINK & WASTE CHUTE

All Stainless Steel Construction

- 9" x 9" x 4" Dump Sink
- 5-1/2" Diameter Waste Chute
- Optional Removable Hinged Doors w/ Lock
- 7" Backsplash
- Stainless Steel Legs w/ Adjustable Stainless Steel Bullet Feet
- PRWC-19 Series Includes 4" O.C. Splash Mt. Swing Spout Faucet
- PRWC-24 Series Includes 4" O.C. Deck Mt. Swing Spout Faucet & Has Rear Deck For Extra Storage



Open Base  
PRWC-19-18 Shown



w/ Hinged Door  
PRWC-19-18-DR Shown

L	Style	w/ SPLASH MT. FAUCET		w/ DECK MT. FAUCET		Approx. Wt.	Approx. Cu. Ft.
		25" WIDE	Price	30" WIDE	Price		
18"	Open Base	PRWC-19-18	\$2038	PRWC-24-18	\$2080	62 lbs.	15
18"	w/ Hinged Door	PRWC-19-18-DR	2302	PRWC-24-18-DR	2345	67 lbs.	15

## W/ STORAGE DRAWERS

All Stainless Steel Construction

- 6" Deep Drawers
- Removable Perforated Drainboard Top
- 1" IPS Drain
- 7" Backsplash
- Stainless Steel Legs w/ Adjustable Stainless Steel Bullet Feet



PR-25-DWR



PR-25-3DWR

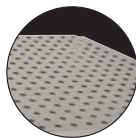

Removable Perforated Drainboard Top

L	Style	25" WIDE	Price	30" WIDE	Price	Wt.	Cu. Ft.
24"	1 Drawer & 1 Door	PR-25-DWR	\$2536	PR-30-DWR	\$3343	62 lbs.	15
24"	3 Drawers	PR-25-3DWR	2766	PR-30-3DWR	3689	85 lbs.	18

108 ADDITIONAL DRAINBOARD CABINET SIZES AVAILABLE - Consult Factory For Details

## ALL STAINLESS STEEL TRASH RECEPTACLES

Trash Bin Not Included

### 36" High Trash Receptacle Cabinet

- Open Bottom w/ Hinged Door
- Accommodates Slim Jim® Trash Can Measuring 11" x 20" x 25" (15 7/8 Gal. Cap.)
- S/S Legs w/ Adj. Stainless Steel Bullet Feet
- Overall Size: 12" x 25" x 36". 60 lbs. 9 Cu. Ft.



PRSJT-12-DR \$1557

### 19" High Trash Receptacle Cabinet

- Open Bottom w/ Hinged Door
- Units Mount Between Equipment Line Up
- Removable S/S Sliding Cover
- Overall Size: 12" x 25" x 21". 35 lbs. 4 Cu. Ft.



PRT-12 \$1268

### Trash Receptacle Cover

- Accommodates Slim Jim® Trash Can Measuring 11" x 20" x 25" (15 7/8 Gallon Capacity)
- Units Mount Between Equipment Line Up
- Overall Size: 12" x 25" x 9". 33 lbs. 4 Cu. Ft.



PRSJT-12 \$698

## Glassware & Liquor Storage

Glass & Liquor Racks Not Included

### GLASS RACK STORAGE CABINETS Featuring All Stainless Steel Construction

- Holds Up To 3 Glass Racks
- Adjustable Glass Rack Slides
- 7" Backsplash
- 1" IPS Drain On Bottom Shelf

- Stainless Steel Legs w/ Adjustable Stainless Steel Bullet Feet
- 30" Wide Units Have Rear Deck For Extra Storage



**Open Top**

**PROR-24-24  
Shown**



**Drainboard Top**

- Removable Perforated Drainboard Top
- 1" IPS Drain

**PRCR-19-24  
Shown**



**Slanted Top**

- Accommodates Liquor Rack On Slanted Top

**PRSR-24-24  
Shown**

Model #	Price	Size	Wt.	Cu.
<b>PROR-19-24</b>	<b>\$1984</b>	24" x 25" x 36"	50 lbs.	12
<b>PROR-24-24</b>	<b>2072</b>	24" x 30" x 36"	57 lbs.	12

Model #	Price	Size	Wt.	Cu.
<b>PRCR-19-24</b>	<b>\$1528</b>	24" x 25" x 36"	80 lbs.	16
<b>PRCR-24-24</b>	<b>1645</b>	24" x 30" x 36"	85 lbs.	17

Model #	Price	Size	Wt.	Cu.
<b>PRSR-19-24</b>	<b>\$2165</b>	24" x 25" x 36"	50 lbs.	12
<b>PRSR-24-24</b>	<b>2256</b>	24" x 30" x 36"	57 lbs.	12



**Add Stainless Steel Full Extension Roller Slides**

**SU-46 \$913 /cabinet**



**Add Stainless Steel Concealing Drawer Front**  
Requires SU-46

**SU-47 \$457 /cabinet**

### LIQUOR DISPLAYS

Tiered Steps & Retaining Bars Securely Display Liquor Bottles



**PLD-2524**



**PRLR-24**

#### Liquor Display Rack

- Retaining Bars Secure Bottles On Steps
- Sound Deadened
- 7" Backsplash
- Stainless Steel Top, Sides & Legs w/ Stainless Steel Bullet Feet
- Adjustable Stainless Steel Side Cross-Bracing
- **30" Wide Units** Has Rear Deck For Extra Storage

	Model #	Price	Overall Length	Approx. Bottle Capacity	Approx. Weight	Approx. Cu. Ft.
<b>25" WIDE</b>	<b>PLD-2512</b>	<b>\$1124</b>	12"	15	25 lbs.	10
	<b>PLD-2518</b>	<b>1201</b>	18"	20	30 lbs.	10
	<b>PLD-2524</b>	<b>1444</b>	24"	30	35 lbs.	10
	<b>PLD-2530</b>	<b>1554</b>	30"	35	40 lbs.	14
	<b>PLD-2536</b>	<b>1710</b>	36"	45	50 lbs.	14
<b>30" WIDE</b>	<b>PLD-3012</b>	<b>1288</b>	12"	15	30 lbs.	12
	<b>PLD-3018</b>	<b>1345</b>	18"	20	35 lbs.	12
	<b>PLD-3024</b>	<b>1455</b>	24"	30	40 lbs.	12
	<b>PLD-3030</b>	<b>1580</b>	30"	35	45 lbs.	17
	<b>PLD-3036</b>	<b>1740</b>	36"	45	55 lbs.	17

#### Liquor Display Cabinet

- All Stainless Steel Construction
- 7" Backsplash
- Stainless Steel Legs w/ Adjustable Stainless Steel Bullet Feet

	Model #	Price	Overall Length	Approx. Bottle Capacity	Approx. Weight	Approx. Cu. Ft.
<b>25" WIDE</b>	<b>PRLR-12</b>	<b>\$1334</b>	12"	15	35 lbs.	7
	<b>PRLR-18</b>	<b>1408</b>	18"	20	36 lbs.	10
	<b>PRLR-24</b>	<b>1476</b>	24"	30	42 lbs.	13
	<b>PRLR-30</b>	<b>1596</b>	30"	35	47 lbs.	14
	<b>PRLR-36</b>	<b>1759</b>	36"	45	50 lbs.	15

### REMOVABLE STAINLESS STEEL LIQUOR DISPLAY COVERS

Includes Padlock & Two Keys



**Display Rack Cover**  
For PLD Models Only

	Length	Model #	Price
<b>25" WIDE</b>	12"	<b>PRLC-2512</b>	<b>\$656</b>
	18"	<b>PRLC-2518</b>	<b>713</b>
	24"	<b>PRLC-2524</b>	<b>770</b>
	30"	<b>PRLC-2530</b>	<b>827</b>
	36"	<b>PRLC-2536</b>	<b>884</b>
<b>30" WIDE</b>	12"	<b>PRLC-3012</b>	<b>725</b>
	18"	<b>PRLC-3018</b>	<b>907</b>
	24"	<b>PRLC-3024</b>	<b>953</b>
	30"	<b>PRLC-3030</b>	<b>987</b>
	36"	<b>PRLC-3036</b>	<b>1021</b>



**Display Cabinet Cover**  
For PRLR Models Only

	Length	Model #	Price
<b>25" WIDE</b>	12"	<b>PRLC-12</b>	<b>\$793</b>
	18"	<b>PRLC-18</b>	<b>935</b>
	24"	<b>PRLC-24</b>	<b>1017</b>
	30"	<b>PRLC-30</b>	<b>1057</b>
	36"	<b>PRLC-36</b>	<b>1117</b>

For Prestige Speed Rails, See Pages 110.

**COVERS ARE FACTORY INSTALLED ONLY**



## Speed Rails & Blender Shelves

### ALL STAINLESS STEEL SPEED RAILS

For Prestige Underbar Equipment

- Sound Deadened
- Keyhole Installation

Single & Double Tier Options Available



Single Tier  
PRSSR-36 Shown



Double Tier  
PRDSR-36 Shown

L	STANDARD SPEED RAILS						W/ LOCKING COVER <small>Includes Keyed Pad Lock</small>						Approx. Wt.	Approx. Cu. Ft.
	SINGLE	Price	Cap.	DOUBLE	Price	Cap.	SINGLE	Price	Cap.	DOUBLE	Price	Cap.		
12"	PRSSR-12	\$184	3	PRDSR-12	\$288	6	PRSSR-12-LC	\$406	3	PRDSR-12-LC	\$621	6	8 lbs.	1
18"	PRSSR-18	197	4	PRDSR-18	359	8	PRSSR-18-LC	506	4	PRDSR-18-LC	820	8	10 lbs.	2
24"	PRSSR-24	212	6	PRDSR-24	424	12	PRSSR-24-LC	560	6	PRDSR-24-LC	942	12	12 lbs.	2
30"	PRSSR-30	227	7	PRDSR-30	487	14	PRSSR-30-LC	615	7	PRDSR-30-LC	1072	14	14 lbs.	3
36"	PRSSR-36	243	9	PRDSR-36	546	18	PRSSR-36-LC	669	9	PRDSR-36-LC	1187	18	14 lbs.	3
42"	PRSSR-42	256	10	PRDSR-42	614	20	PRSSR-42-LC	727	10	PRDSR-42-LC	1319	20	16 lbs.	4
48"	PRSSR-48	268	12	PRDSR-48	678	24	PRSSR-48-LC	782	12	PRDSR-48-LC	1446	24	16 lbs.	4
54"	PRSSR-54	286	13	PRDSR-54	745	26	NOT AVAILABLE						18 lbs.	5
60"	PRSSR-60	301	15	PRDSR-60	805	30							20 lbs.	5
72"	PRSSR-72	328	18	PRDSR-72	935	36							24 lbs.	6
84"	PRSSR-84	358	21	PRDSR-84	1062	42							28 lbs.	7
96"	PRSSR-96	387	24	PRDSR-96	1175	48							32 lbs.	8

### Hang-On Style Speed Rails

- Designed To Hang-on The First Tier Of Any PRSSR Series Speed Rails
- Doubles Liquor Storage
- Removable

*Not To Be Used With Any Other Manufacturers Speed Rails*

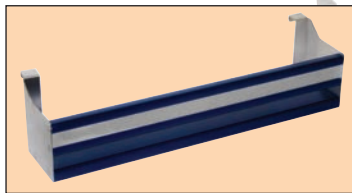

L	Model #	Price	Cap.	Approx. Wt.	Approx. Cu. Ft.
12"	PRHSR-12	\$203	3	4 lbs.	1
18"	PRHSR-18	218	4	4 lbs.	2
24"	PRHSR-24	233	6	5 lbs.	2
30"	PRHSR-30	247	7	6 lbs.	2
36"	PRHSR-36	266	9	6 lbs.	3
42"	PRHSR-42	279	10	7 lbs.	3
48"	PRHSR-48	299	12	7 lbs.	4

For Prestige Liquor Racks & Cabinets, See Page 109.

### BLENDER SHELVES

Mounts To The Front Apron Of Ice Bin

- All Stainless Steel Construction
- 10" Wide
- Grommet Hole For Blender Power Cords
- 15A - 120V Duplex Outlet Hidden Beneath Blender Shelf
- Keyhole Installation



15A - 120V Duplex Receptacle Hidden Beneath Blender Shelf



**EXCLUSIVELY**

For Prestige Underbar Equipment

PRA-BS-12	12" Shelf .....	\$249
PRA-BS-18	18" Shelf .....	267
PRA-BS-24	24" Shelf .....	305
PRA-BS-30	30" Shelf .....	315

For Free-Standing Blender Stations, See Page 107.

# FRIDGE & COOLERS

## Back Bar Refrigeration & Coolers

### GLASS FROSTERS

- Stainless Steel Sliding Lids
- 2 Adjustable Dividers & Shelving
- **GF24-B:** 100 8" Plates/76 Mugs
- **GF34-B:** 150 8" Plates/94 Mugs
- Foam Polyurethane Insulation
- Automatic Defrosting
- R404A Refrigerant
- Black Vinyl Coated Steel
- 6' NEMA5-15P Electrical Cord
- 7 Amps/115V/1 Phase
- 2 Year Parts/Labor 5 Year Compressor (Parts) Warranty



NEMA PLUG 5-15P



GF24-B

Model #	Price	Size	Wt.	Cu. Ft.
<b>GF24-B</b>	<b>\$6566</b>	24" x 26" x 33 5/8"	183 lbs.	13
<b>GF34-B</b>	<b>6644</b>	34" x 26" x 33 5/8"	227 lbs.	19
<b>GF48-B</b>	<b>8446</b>	48" x 26" x 33 5/8"	276 lbs.	26

### BOTTLE/CAN COOLERS

- Stainless Steel Construction w/ Black Vinyl Exterior
- Sliding Stainless Steel Lid(s)
- Built In Bottle Opener & Cap Catcher
- Adjustable Dividers
- Ventilated Cooling Fan System
- Uses R134A Refrigerant
- Efficient Forced-Air Refrigeration System To Maintain Temperatures Between 32° And 41° Fahrenheit
- Automatic Defrosting
- Foam Polyurethane Insulation
- 8' NEMA5-15P Electrical Cord
- Single Phase Wiring
- 2 Year Parts/Labor 5 Year Compressor (Parts) Warranty



NEMA PLUG 5-15P



BC-B-50

Black Finish	Price	O.A. Dimensions	# of 12 oz. Bottles/Cans	Dividers	Lids	Amps/Volts	HP	Wt.	Cu.
<b>BC-B-35</b>	<b>\$5614</b>	35" x 26 1/2" x 33 7/8"	9-1/3 Cases / 11-1/2 Cases	2	1	4.5/115v	1/5	214 lbs.	19
<b>BC-B-50</b>	<b>6268</b>	50" x 26 1/2" x 33 7/8"	17-1/2 Cases / 23-3/4 Cases	3	2	6.3/115v	1/3	378 lbs.	27
<b>BC-B-65</b>	<b>7037</b>	65" x 26 1/2" x 33 7/8"	25-1/4 Cases / 34-3/4 Cases	4	2	6.3/115v	1/3	388 lbs.	35

### BACK BAR REFRIGERATION



- Stainless Steel Top w/ Black Vinyl Coated Steel Sides
- Hinged Door(s) With Locks
- Adjustable Epoxy Shelves
- Interior Lighting with On/Off switch
- 8' NEMA5-15P Electrical Cord
- Single Phase Wiring
- Uses R134A Refrigerant
- 2 Year Parts/Labor 5 Year Compressor (Parts) Warranty



BBR-48

	Model #	Price	O.A. Dimensions	# of Kegs	Shelves	Doors	Amps/Volts	HP	Wt.	Cu.
<b>23 1/2" WIDE</b>	<b>BBR-36</b>	<b>\$7717</b>	36" x 23 1/2" x 36"	2	2	1	5.0/115v	1/5	250 lbs.	18
	<b>BBR-48</b>	<b>7966</b>	48" x 23 1/2" x 36"	2	4	2	5.0/115v	1/4	306 lbs.	26
	<b>BBR-72</b>	<b>9086</b>	72" x 23 1/2" x 36"	3	6	3	5.0/115v	1/4	366 lbs.	36
<b>28 3/16" WIDE</b>	<b>BBR-59</b>	<b>8277</b>	59" x 28 3/16" x 37 1/4"	2	4	2	7.2/115v	1/3	354 lbs.	37
	<b>BBR-79</b>	<b>10579</b>	79" x 28 3/16" x 37 1/4"	4	4	3	7.2/115v	1/3	439 lbs.	50
	<b>BBR-95</b>	<b>12309</b>	95" x 28 3/16" x 37 1/4"	5	6	3	7.2/115v	1/3	498 lbs.	60



NEMA PLUG 5-15P

**Stainless Steel Exterior Upgrade**  
**BBR-1**  
**\$700 /per unit**  
 For BBR Series, BC-B Series, GF Series Only

**Add Glass Doors**



**SU-100**  
**\$1100 /per unit**  
 For BBR Series

**Add Casters**



**BBR-25-3 3" Casters**  
**\$431/per unit**  
 For BBR Series, BC-B Series, GF Series Only

**BBR-25-6 6" Casters**  
**\$453/per unit**  
 For BBR Series

# UNDERBAR ACCESSORIES

## Underbar Modifications & Accessories

### More Underbar Accessories

<b>A-1</b>	Perforated Cover for 10" x 14" x 10" Sink Bowl	.....	<b>\$120</b>
<b>SU-17</b>	Interior Partition (For Underbar Basics & Prestige Drainboard Cabinets - Factory Installed Only)	.....	<b>210</b>
<b>K-12</b>	Replacement Deck Mounted Soap Dispenser	.....	<b>137</b>
<b>SU-55</b>	Removable Stainless Steel Divider For Beer Box	.....	<b>169</b>

### Underbar Modifications

<b>A-51</b>	6" Hole In Drainboard Surface <i>(Waste Chute Installation)</i>	.....	<b>146</b>
<b>PR-STRAP</b>	Stainless Steel Straps For Speed Rails <i>(Set of 2 - For KS-2K Speed Rail Only)</i>	.....	<b>43</b>
<b>SU-4</b>	Modify Prestige Series Backsplash to 4" Tall	.....	<b>24 Lin. Ft.</b>
<b>SU-10A</b>	Upgrade To S/S Legs & Bullet Feet <i>(18" Legs - Includes Adjustable Front-to-Back Cross-Bracing)</i>	.....	<b>243</b>
<b>SU-10B</b>	Upgrade To S/S Legs & Bullet Feet <i>(10" Legs - Includes Adjustable Front-to-Back Cross-Bracing)</i>	.....	<b>243</b>
<b>SU-10C</b>	Upgrade To S/S Legs & Bullet Feet <i>(14" Legs - Includes Adjustable Front-to-Back Cross-Bracing)</i>	.....	<b>243</b>
<b>SU-13</b>	Upgrade to 10-Circuit Cold Plate <i>(Applies to units with 7-Circuit Cold Plate)</i>	.....	<b>447</b>
<b>SU-18RorL</b>	Right or Left Welded Side Splash for 18" Wide Unit	.....	<b>161</b>
<b>SU-18RL</b>	Right & Left Welded Side Splash for 18" Wide Unit	.....	<b>325</b>
<b>SU-21RorL</b>	Right or Left Welded Side Splash for 21" Wide Unit	.....	<b>175</b>
<b>SU-21RL</b>	Right & Left Welded Side Splash for 21" Wide Unit	.....	<b>341</b>
<b>SU-22A</b>	Add 10"x14"x10" Sink To Drbd. Cabinet <i>(Includes Splash Mt. Faucet)</i>	.....	<b>924</b>
<b>SU-22B</b>	Add 9-1/2"x11-1/2"x6" Sink To Drbd. Cabinet <i>(Includes Splash Mt. Faucet)</i>	.....	<b>924</b>
<b>SU-22C</b>	Add 9" x 9" x 4" Sink To Drbd. Cabinet <i>(Includes Splash Mt. Faucet)</i>	.....	<b>924</b>
<b>SU-24</b>	Provision To Connect Underbar Equipment <i>(Price Per Every Two Units)</i>	.....	<b>140</b>
<b>SU-30</b>	Soda Chase Provision - Tip-Out <i>(For Ice Bins w/ Backsplash Only)</i>	.....	<b>447</b>
<b>SU-33</b>	Working Height to Underbar Equipment	.....	<b>95</b>
<b>SU-34</b>	Top Cutout for Under Bar Equipment	.....	<b>249</b>
<b>SU-36</b>	Add 5-1/2" Diameter Waste Chute <i>(Blender Stations &amp; Drainboard Cabinets Only)</i>	.....	<b>833</b>
<b>SU-40</b>	Prep Unit For Installation Of Speed Rails	.....	<b>81</b>
<b>SU-41</b>	Make Speed Rail An Odd Length	.....	<b>68</b>
<b>SU-42</b>	Make Speed Rail Accommodate 1/2 Gallon Bottles	.....	<b>89</b>
<b>SU-61</b>	Special Sizing To Reduce Length	.....	<b>N/C</b>
<b>SU-61A</b>	Special Modification	.....	<b>249</b>
<b>SU-62C</b>	Recess GFI Outlet For Bar Die	.....	<b>548</b>
<b>SU-68</b>	Omit Corrugation On Drainboards <i>(Flat Top Work Surface)</i>	.....	<b>145</b>
<b>SU-79</b>	Additional Drainboard Length <i>(Flat Top Work Surface)</i>	.....	<b>136 Lin. Ft.</b>

### PERFORATED BASKETS FOR UNDERBAR SINKS



**A-16 \$239**  
Fits 10" x 14" x 10" Sink



**A-17 \$234**  
Fits 9 1/2" x 11 1/2" x 6" Sink  
**A-17A \$242**  
Fits 9" x 9" x 4" Sink



**A-23 \$224**  
Fits 6" x 11" x 6" Sink

### REMOVABLE BLACK PLASTIC BOTTLE RACKS



**A-19 \$16 ea.**  
Single Bottle Rack  
5 1/4" x 5 1/4"



**A-20 \$46 ea.**  
3-Pack Bottle Rack  
(6 Per Carton. Must Order in Qties. of 6)  
5 1/4" x 15 7/8"



**A-18 \$42 ea.**  
4-Pack Bottle Rack  
5" x 16 1/2"

### STAINLESS STEEL FALSE BOTTOM



- A-41** For 24" Ice Bin..... **\$112**
- A-42** For 30" Ice Bin..... **122**
- A-43** For 36" Ice Bin..... **135**
- A-44** For 42" Ice Bin..... **146**
- A-45** For 48" Ice Bin..... **156**

### SLIDING STAINLESS STEEL COVER For Free-Standing Underbar Basics Ice Bins



- SSC-12** For 12" Ice Bin ..... **\$169**
- SSC-24** For 24" Ice Bin ..... **174**
- SSC-30** For 30" Ice Bin ..... **190**
- SSC-36** For 36" Ice Bin ..... **205**
- SSC-42** For 42" Ice Bin ..... **256**
- SSC-48** For 48" Ice Bin..... **263**
- SSC-PT** For Pass-Thru Ice Bin..... **335**

Replacement Sliding S/S Covers For Drop-in Ice Bins, See Page 84

### STAINLESS STEEL ICE BIN PARTITION



- A-38** 8" High..... **\$122**
- A-39** 12" High..... **122**
- A-40** 16" High..... **122**



**A-24 \$169**  
8" x 8" Add-On Blender Shelf  
w/ Duplex Outlet Hidden Beneath Shelf



**K-316-LU \$109**  
Add Wrist Handles  
For Deck Or Splash Mt. Faucets

# UNDERBAR ACCESSORIES

## Prestige Underbar Modifications & Accessories

### Prestige Ice Bin Accessories



<b>PRA-BR-3</b>	3-Bottle Well Support Frame For Ice Bin <i>(For 20" Wide Units &amp; Required For Use w/ Cover - Bottle Wells Not Included - Use A-20)</i>	.....	<b>\$108</b>
<b>PRA-2405</b>	24" Condiment Rack (5 Condiment Cups) <i>Condiment Racks Hang On Backsplash Of Ice Bin</i>	.....	<b>559</b>

### Prestige Bar Sink Accessories

<b>SU-20RorL</b>	Right or Left Side Splash for 20" Wide Unit	.....	<b>179</b>
<b>SU-20RL</b>	Right & Left Side Splash for 20" Wide Unit	.....	<b>375</b>
<b>SU-25RorL</b>	Right or Left Side Splash for 25" Wide Unit	.....	<b>213</b>
<b>SU-25RL</b>	Right & Left Side Splash for 25" Wide Unit	.....	<b>402</b>

### Prestige Underbar Modifications

<b>SU-4</b>	Modify Prestige Series Backsplash to 4" Tall	.....	<b>24</b>	Lin. Ft.
<b>SU-27</b>	Cabinet Door Lock w/ Key	.....	<b>272</b>	
<b>SU-30</b>	Soda Chase Provision <i>(For Ice Bins w/ Backsplash Only)</i>	.....	<b>447</b>	
<b>SU-36</b>	Add Waste Chute (Blender Stations Only)	.....	<b>833</b>	
<b>SU-44</b>	Add S/S Glass Rack Slides <i>(Prestige Glass Rack Storage Cabinets Only)</i>	.....	<b>548</b>	2/Set
<b>SU-46</b>	Add S/S Full Extension Roller Slides <i>(Prestige Glass Rack Storage Cabinets Only)</i>	.....	<b>913</b>	
<b>SU-47</b>	Add S/S Concealing Drawer Front <i>(Prestige Glass Rack Storage Cabinets Only)</i>	.....	<b>457</b>	
<b>SU-62C</b>	Recess GFI Outlet For Bar Die <i>(Wiring by Others)</i>	.....	<b>548</b>	
<b>SU-73</b>	Add Mirror Finish <i>Factory Install Only</i>	.....	<b>408</b>	
<b>SU-74</b>	All Stainless Steel Construction Upgrade	.....	<b>486</b>	
<b>SU-75</b>	Add Welded Stainless Steel Cross-Bracing	.....	<b>117</b>	
<b>SU-77</b>	Modify Cabinet to be 25" Wide <i>(Prestige Drainboard Cabinets Only)</i>	.....	<b>83</b>	

## SODA GUN HOLDER

Mounts In Prestige Underbar Line Up

- Provides Housing For WunderBar® Soda Gun (14 Button or Smaller)
- Built-In Soda Gun Holder with Drip Cup
- Cover Allows Easy Access To Make Adjustments
- Keeps Tubing Lines Hidden For A Cleaner Workspace
- Includes Backsplash



PRSH-19-6 Shown

Model #	Price	Size* L x W x H	Approx. Weight	Approx. Cu. Ft.	NSF
<b>SINGLE SODA GUN HOLDER (Holds One Gun On One Side)</b>					
<b>PRSH-19-6</b>	<b>\$610</b>	20" x 6" x 36"	19 lbs.	3	
<b>PRSH-24-6</b>	<b>696</b>	25" x 6" x 36"	20 lbs.	3	

For 4" Wide Soda Holder add **SU-61 N/C**

\*Height is from the finished floor to the top of the splash

NOTE: Drain Connection Is Required On Drip Cup

## PRESTIGE Signature Series



### TUBING CHASE

<b>PRA-19-TC</b>	For 20" Unit.....	<b>\$203</b>
<b>PRA-24-TC</b>	For 25" Unit.....	<b>211</b>

### STAINLESS STEEL TRASH RECEPTACLE COVER

*Trash Bin Not Included • Factory Install Only*



### PRSJT-12 \$698

- Open Unit
- Accommodates Slim Jim® Trash Can Measuring 11" x 20" x 25" (15 7/8 Gallon Capacity)\*
- Units Mount Between Equipment Line Up
- Overall Size: 12" x 25" x 21"
- 33 lbs. 4 Cu. Ft.

### SLIDING STAINLESS STEEL COVERS For Ice Bins



<b>PRA-SSC-12</b>	For 12" Ice Bin.....	<b>\$193</b>
<b>PRA-SSC-18</b>	For 18" Ice Bin.....	<b>196</b>
<b>PRA-SSC-24</b>	For 24" Ice Bin.....	<b>200</b>
<b>PRA-SSC-30</b>	For 30" Ice Bin.....	<b>218</b>
<b>PRA-SSC-36</b>	For 36" Ice Bin.....	<b>234</b>
<b>PRA-SSC-42</b>	For 42" Ice Bin.....	<b>294</b>
<b>PRA-SSC-48</b>	For 48" Ice Bin.....	<b>302</b>
<b>PRA-SSC-PT</b>	For Pass-Thru Ice Bin.....	<b>463</b>

## PRESTIGE UNDERBAR ADD-ONS

### Stainless Steel Underbar Fillers

**Multiple Angles Available • Optional Legs**

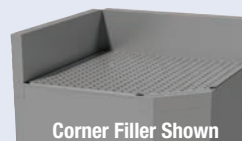

- Removable Perforated Drainboard Top
  - Bolt On To Sides Of Equipment
  - For Odd Shape Underbar Line Ups
- See Page 106

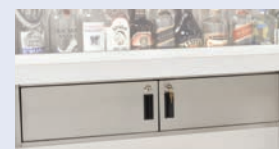

### Stainless Steel Base Cabinet

**Available With Or Without Doors**

- Provides Extra Storage In Bar Line Up
- Optional Door Lock

Contact Our SmartFab Department For Details & Pricing.  
SmartFab@advancetabco.com • 800-645-3166



# FAUCETS

## Underbar Equipment Faucets

All Items on This Page Ship via UPS

All Faucets Meet Federal Lead Free Standards

### UNDERBAR DECK MOUNTED SINK FAUCETS

6" Deck Mounted Faucet



**K-51 \$430**  
4" O.C.

3-1/2" Gooseneck



**K-52 \$210**  
4" O.C.

12" Swing Spout



**K-53 \$407**  
4" O.C.

Water Filler Faucet



**K-54**  
8-1/4" High **\$446**  
**K-54A**  
12" High **\$549**

Acrylic Lever Arm

Deck Mt. 6" Extended Spout 4" O.C.



**K-124 \$310**

**K-208 \$424**  
With Wrist Handles

Dipper Well Faucet



**A-33 \$146**

Gooseneck Deck Mount Melt Down Nozzle 4" O.C.



**A-29 \$475** **A-30 \$543** (Installed)

### UNDERBAR SPLASH MOUNTED SINK FAUCETS

3-1/2" Splash Mounted Faucet



**K-59 \$210**  
4" O.C.

Extra Heavy Duty Splash Mounted Faucet



**K-69 \$423**  
4" O.C.

Splash Mt. 6" Extended Spout 4" O.C.



**K-123 \$310**

Splash Mt. 6" Extended Spout with Wrist Handles



**K-206 \$405**  
4" O.C.

6" Splash Mounted Faucet



**K-125 \$281**  
4" O.C.

10" Splash Mounted Spout



**K-126 \$281**  
4" O.C.

Wrist Handles for Faucets



**K-316-LU \$109**

### UNDERBAR SINK ACCESSORIES

#### WASTE OUTLETS & CHUTES

1" Waste Outlet



**A-10**  
(6 per carton)  
**\$18**

1-1/2" Waste Outlet



**A-11**  
(6 per carton)  
**\$19**

5-1/2" Stainless Steel Open Waste Chute



**A-6 \$309**  
Factory Installed

5-1/2" Dipper Well with Insert and Drain



**A-7 \$384**  
Factory Installed (Includes  
TA-34 Table Top 6" Cut-Out)  
1-1/2" NPT Drain Connection

#### STAINLESS STEEL OVERFLOW PIPES



**1" Pipe**  
(6 per carton)  
**A-12 \$18**



**1-1/2" Pipe**  
(6 per carton)  
**A-13 \$19**

#### SOAP DISPENSERS & HOLDERS

Deck Mounted Soap Dispenser



**K-12 \$137**

Chrome Towel Ring  
(Packed Loose)



**A-15 \$96**

# PORTABLE BARS

## Portable Bars

### Standard Features:

- Integral Ice Bin
- Drain & Shut-Off Valve
- Dual Plastic Speed Rails To Hold Up To 10 Bottles Of Liquor

- Towel Ring(s)
- Standard Black Mica Finish On All Sides
- Open Bottom Shelf For Glass Rack Storage



## ABS MOLDED WORK TOP

- ABS Molded Plastic Work Area
- 18" x 14" x 10" Deep Drawn Integral Molded Ice Bin
- 4" Swivel Plate Casters (2 w/ Brakes)

**Designed For Light-Duty Use By Small Hotels,  
VFW Halls And Catering Facilities**

Model	Price	Length	Width	Bar Top Width	Wt.	Cu. Ft.
M-B	\$3853	61"	24.50"	11"	280 lbs.	60



M-B Shown

## STAINLESS STEEL WORK TOP

- Stainless Steel Work Area
- 18" x 20" x 10" S/S Integral Ice Bin
- Towel Ring
- Dual Stainless Steel Speed Rails To Hold Up To 10 Bottles Of Liquor
- 4" Swivel Plate Casters (2 w/ Brakes)

**Designed For Light-Duty Use By Small Hotels,  
VFW Halls And Catering Facilities**

Model	Price	Length	Width	Bar Top Width	Wt.	Cu. Ft.
D-B	\$4408	61"	24.50"	11"	310 lbs.	60



D-B Shown

## STAINLESS STEEL WORK TOP, BACK & SIDES

- Stainless Steel Work Top, Back & Sides
- 19" x 13-1/2" x 11" Stainless Steel Integral Insulated Ice Bin
- 2 Towel Rings
- Dual Stainless Steel Speed Rails To Hold Up To 10 Bottles Of Liquor
- 5" Heavy Duty Swivel Plate Casters (2 w/ Brakes)

**Designed For Heavy-Duty Use.  
Perfect for High Volume Operation!**

Model	Price	Length	Width	Bar Top Width	Wt.	Cu. Ft.
R-8-B	\$9373	95.75"	24.50"	12"	550 lbs.	117



## Portable Bar Modifications & Accessories



BK-2



DT-2



SU-80



-7

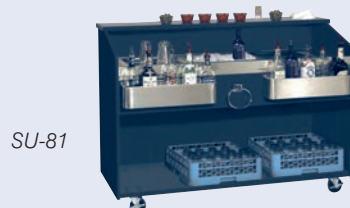

SU-81

**-7** 7-Circuit Cold Plate Sealed Into Bottom Of Ice Bin.... **\$1630**  
Add The Suffix -7 To The Model Number & Add To Cost  
(Factory Installed Only)

**BK-2** Stainless Steel Speed Rail..... **106**

**DT-2** Double Tier Stainless Steel..... **191**  
Speed Rail

**SU-80** Continuous Bumper on 3 Sides..... **865**

**SU-81** Custom Mica Colors..... **1412**

*Custom Colors Include Exterior  
Finishes Only (Bar Front And Sides. Additional Charge  
For Bar Top. All Interiors Are Standard Black Finish)*

# PORTABLE BARS

## Heavy Duty Portable Bars

**Custom Colors Available!**  
(See Pg. 115 for details)

**Standard Features:**

- Stainless Steel Work Top, Sides And Bottom
- 19" x 13-1/2" x 11" Stainless Steel Integral Insulated Ice Bin
- Full Perimeter Bumpers
- 5" Heavy Duty Swivel Plate Casters (2 w/ Brakes)
- Drain & Shut-Off Valve
- Two Stainless Steel Speed Rails To Hold Up To 10 Bottles Of Liquor
- Towel Ring(s)
- Standard Black Mica Finish On Top & Front
- Open Bottom Shelf For Glass Rack Storage

**ALL STAINLESS STEEL INTERIOR!**  
Designed For Heavy-Duty, High Volume Operation!



AMS-5B Front Shown

## HEAVY DUTY

Model	Price	Length	Width	Bar Top Width	# Of Speed Rails	Bottle Capacity Per Speed Rail (750ml Bottles)	Wt.	Cu. Ft.
AMS-5B	\$5578	62 1/4"	27 1/4"	12"	2	8 ea./16 Total	315 lbs.	70
AMS-6B	6198	74 3/8"	27 1/4"	12"	2	10 ea./20 Total	399 lbs.	73



AMS-5B Rear Shown

## HEAVY DUTY WITH STAINLESS STEEL DOORS

**Standard Features:**

- Stainless Steel Work Top, Sides And Bottom
- 19" x 13-1/2" x 11" Stainless Steel Integral Insulated Ice Bin
- Full Perimeter Bumpers
- 5" Heavy Duty Swivel Plate Casters (2 w/ Brakes)
- Drain & Shut-Off Valve
- Stainless Steel Speed Rails To Hold Up To 10 Bottles Of Liquor
- Towel Ring(s)
- Standard Black Mica Finish On Top & Front
- Open Bottom Shelf For Glass Rack Storage
- 2 Hinged Doors with Locks

Model	Price	Length	Width	Bar Top Width	# Of Speed Rails	Bottle Capacity Per Speed Rail (750ml Bottles)	Wt.	Cu. Ft.
AMD-5B	\$6220	62 1/4"	28 1/8"	12"	2	6 ea./12 Total	340 lbs.	71
AMD-6B	6841	74 3/8"	28 1/8"	12"	3	6 ea./18 Total	399 lbs.	73



AMD-6B Rear Shown

**Upgrade for Stainless Steel Front & Cold Plates Available. Contact Factory Available Consult Factory**  
**See Page 115 For All Portable Bar Modifications & Accessories.**

## PORTABLE CASH REGISTER STAND

- Stainless Steel Interior, Frame And Bottom
- Adjustable European Flush Mount Hinges
- Full Perimeter Bumpers
- Locking Door
- Mid-Shelf
- Black Mica Finish On Door, Top & Sides
- Open Bottom Shelf For Glass Rack Storage
- 4" Swivel Casters, 2 With Brakes

Model	Price	Length	Width	Height	Wt.	Cu. Ft.
AMD-2B	\$2075	24.5"	23.5"	40.5"	160 lbs.	27



Includes Lock & Key



# ADVANCE TABCO HOT & COLD FOOD TABLES & DROP-INS

## Features:

- Stainless Steel Body, Top & Sides
- Fiberglass Insulation (Excludes Solid Top Tables)
- 1" I.P.S. Drain (Excludes Solid Top Tables)
- Galvanized Legs with Adjustable Bullet Feet

### Refrigerated & Hot Well Drop-Ins



### Electric & Gas Hot Food Tables



### Solid Top Tables



### Everyday Buffet Tables



### Ice-Cooled Tables



### Refrigerated Tables



### Sealed Wells

These units allow water to be poured directly into the unit and get heated. Food bins may be used without the use of a Spillage Pan.



### Standard Wells

Never pour water directly into these type of units. To use hot water in these units, must use with **Model# SP-A** Aluminum Spillage Pans or **Model # SP-S** S/S Spillage Pans.



### Refrigerated

These units are designed to maintain chilled foods at the proper temperature.

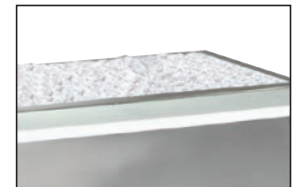

### Non-Refrigerated

Units are designed to cool foods already chilled using only ice within its insulated bin. There is no refrigeration unit in this equipment.





# HOT WELL DROP-INS

## Electric Sealed Well Hot Food Drop-In Units

- 304 Stainless Steel Top
- Fiberglass Insulation Between Compartments
- 12" X 20" Die Stamped Pan Openings
- 6" Deep Units

- 1" I.p.s. Drain
- Remote Control Panel
- Infinite Control Knobs
- Indicator Lights

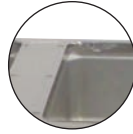

Individual Sealed Well Compartments



DISW-3-120 Shown

### STANDARD DROP-IN UNITS

Model #	Price	Length	Width	# of Wells	Cut-Out Size	Volts	Amps	Watts	Approx. Wt.	Cu. Ft.
DISW-1-120	\$2001	18-13/16"	26-3/4"	1	23-3/8" x 17-1/4"	120	9.17	1100	73 lbs.	6
DISW-2-120	2894	34-1/8"	26-3/4"	2	23-3/8" x 32-5/8"	120	12.34	2200	110 lbs.	6
DISW-3-120	3513	49-7/16"	26-3/4"	3	23-3/8" x 47-7/8"	120	27.51	3300	135 lbs.	6
DISW-1-240	2001	18-13/16"	26-3/4"	1	23-3/8" x 17-1/4"	208/240	3.97/4.58	825/1100	73 lbs.	6
DISW-2-240	2894	34-1/8"	26-3/4"	2	23-3/8" x 32-5/8"	208/240	7.94/9.16	1650/2200	110 lbs.	6
DISW-3-240	3513	49-7/16"	26-3/4"	3	23-3/8" x 47-7/8"	208/240	11.91/13.74	2475/3300	135 lbs.	18
DISW-4-240	4173	64-3/4"	26-3/4"	4	23-3/8" x 63-1/4"	208/240	15.88/18.32	3300/4400	180 lbs.	23
DISW-5-240	5434	80-1/16"	26-3/4"	5	23-3/8" x 78-1/2"	208/240	19.85/22.90	4125/5500	208 lbs.	35
DISW-6-240*	6409	95-3/8"	26-3/4"	6	23-3/8" x 93-7/8"	208/240	23.82/27.48	4950/6600	275 lbs.	35

\*6-well unit include two sets of control panels

**NOTE:** Units are not designed to cook or heat frozen or refrigerated foods. Food placed in tables should already be hot, and the table will maintain the proper temperatures



DISLSW-2-120 Shown

### SLIMLINE DROP-IN UNITS

Model #	Price	Length	Width	# of Wells	Cut-Out Size	Volts	Amps	Watts	Approx. Wt.	Cu. Ft.
DISLSW-2-120	\$3201	47-9/16"	16.44"	2	15-1/8" x 45-7/8"	120	18.34	2200	95 lbs.	11
DISLSW-3-120	3841	70-3/8"	16.44"	3	15-1/8" x 68-3/4"	120	27.51	3300	125 lbs.	11
DISLSW-2-240	3201	47-9/16"	16.44"	2	15-1/8" x 45-7/8"	208/240	3.94/9.16	1600/2200	95 lbs.	18
DISLSW-3-240	3841	70-5/8"	16.44"	3	15-1/8" x 68-3/4"	208/240	11.90/13.34	2475/3300	150 lbs.	18
DISLSW-4-240	5393	93-3/16"	16.44"	4	15-1/8" x 91-1/2"	208/240	15.88/18.32	3300/4400	155 lbs.	23

### Drop-In Unit Options & Accessories

OPTIONAL NEMA 6' CORD WITH PLUGS AVAILABLE:

Drop-In Units to be hard wired in the field. Please consult the factory for more information.



NEMA 5-15P  
SU-P-234

1 well, 120v Units



NEMA L5-30P  
SU-P-232

1, 2, 3 or 6 well, 240v Units  
(6 well unit requires 2 Cords)



NEMA 6-20P  
SU-P-231

2 or 3 well, 120v Units

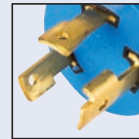

NEMA L6-30P  
SU-P-233

4 or 5 well, 240v Units



**Thermostatic Controls**  
Add The Suffix **-T** To The Model Number And Add Additional Pricing Below.  
**\$203** Per Well

**3-Phase Upgrade**  
Upgrade 240 volt units to 3 Phase Wiring.  
**SU-72 \$448** Per Unit



**Filler Faucet**

- Hot Water Supply Only
  - Requires **-M** Manifold Drain Assembly (See below)
  - Faucet Location To Be Specified When Ordering
- K-49 \$353**



**Manifold Drain Assembly**

Add The Suffix **-M** To The Model Number And Add Additional Pricing Below.  
**\$230** Per Well

# HOT FOOD TABLES

## Electric Hot Food Tables



- Stainless Steel Body & Top
- Galvanized Legs, Undershelf & Adjustable Bullet Feet
- Enclosed Base Units Include Stainless Steel Body & Shelf
- Fiberglass Insulation Between Each Compartment
- 8" Wide Poly Cutting Board Shelf - Ships K.D.

- Galvanized Liner. (Optional Stainless Steel Liner upgrade available **Model # SU-32 \$115 per well**)
- Infinite Control Knobs & Indicator Lights
- Single Phase Wiring (Upgrade to 3 Phase Wiring for 240 Volt Units- **Model # SU-72 - \$448**)



**w/ Undershelf**  
HF-2E-240 Shown

### Undershelf

Model #	Price	Length	Width*	# of Wells	Volts	Amps	Watts	NEMA Plug	Wt.	Cu. Ft.
HF-2E-120	\$1993	31-13/16"	30-5/8"	2	120	8.33	1000	5-20P	92 lbs.	28
HF-3E-120	2148	47-1/8"	30-5/8"	3	120	12.50	1500	5-20P	130 lbs.	41
HF-4E-120	2907	62-7/16"	30-5/8"	4	120	16.67	2000	L5-30P	152 lbs.	55
HF-2E-240	1993	31-13/16"	30-5/8"	2	208/240	7.21/8.33	1500/2000	6-20P	92 lbs.	28
HF-3E-240	2148	47-1/8"	30-5/8"	3	208/240	10.82/12.50	2250/3000	6-20P	120 lbs.	41
HF-4E-240	2907	62-7/16"	30-5/8"	4	208/240	14.42/16.67	3000/4000	L6-30P	152 lbs.	55
HF-5E-240	3843	77-3/4"	30-5/8"	5	208/240	18.03/20.84	3750/5000	L6-30P	170 lbs.	67

\*Width Includes 8" Cutting Board

See Below For Stainless Steel Legs & Undershelf Upgrade

### Enclosed Base

Model #	Price	Length	Width*	# of Wells	Volts	Amps	Watts	NEMA Plug	Wt.	Cu. Ft.
HF-2E-120-BS	\$3860	31-13/16"	30-5/8"	2	120	8.33	1000	5-20P	92 lbs.	28
HF-3E-120-BS	4254	47-1/8"	30-5/8"	3	120	12.50	1500	5-20P	210 lbs.	41
HF-4E-120-BS	5168	62-7/16"	30-5/8"	4	120	16.67	2000	L5-30P	250 lbs.	55
HF-2E-240-BS	3860	31-13/16"	30-5/8"	2	208/240	7.21/8.33	1500/2000	6-20P	92 lbs.	28
HF-3E-240-BS	4254	47-1/8"	30-5/8"	3	208/240	10.82/12.50	2250/3000	6-20P	210 lbs.	41
HF-4E-240-BS	5168	62-7/16"	30-5/8"	4	208/240	14.42/16.67	3000/4000	L6-30P	250 lbs.	55
HF-5E-240-BS	6162	77-3/4"	30-5/8"	5	208/240	18.03/20.84	3750/5000	L6-30P	290 lbs.	67

\*Width Includes 8" Cutting Board



**Enclosed Base**  
HF-5E-240-BS Shown with  
Optional TA-255P Casters

### Enclosed Base w/ Sliding Doors

Model #	Price	Length	Width*	# of Wells	Volts	Amps	Watts	NEMA Plug	Wt.	Cu. Ft.
HF-2E-120-DR	\$4449	31-13/16"	30-5/8"	2	120	8.33	1000	5-20P	127 lbs.	28
HF-3E-120-DR	4984	47-1/8"	30-5/8"	3	120	12.50	1500	5-20P	155 lbs.	41
HF-4E-120-DR	5891	62-7/16"	30-5/8"	4	120	16.67	2000	L5-30P	197 lbs.	55
HF-2E-240-DR	4449	31-13/16"	30-5/8"	2	208/240	7.21/8.33	1500/2000	6-20P	127 lbs.	28
HF-3E-240-DR	4984	47-1/8"	30-5/8"	3	208/240	10.82/12.50	2250/3000	6-20P	155 lbs.	41
HF-4E-240-DR	5891	62-7/16"	30-5/8"	4	208/240	14.42/16.67	3000/4000	L6-30P	197 lbs.	55
HF-5E-240-DR	6852	77-3/4"	30-5/8"	5	208/240	18.03/20.84	3750/5000	L6-30P	215 lbs.	67

\*Width Includes 8" Cutting Board



**w/ Sliding Doors**  
HF-5E-240-DR Shown

**NOTE:** Units are not designed to cook or heat frozen or refrigerated foods. Food placed in tables should already be hot, and the table will maintain the proper temperatures

## Food Table Modifications & Accessories

For Our Full Line Of Hot Food Table Modifications, Accessories & Replacement Parts, See Page 131-134

Stainless Steel Legs & Undershelf Upgrade \$659			
2 Wells	3 Wells	4 Wells	5 Wells
SU-23A	SU-23B	SU-23C	SU-23D

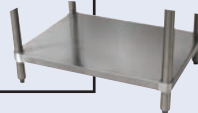

SP-S  
Spillage Pan

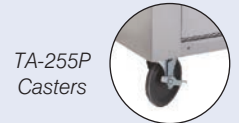

TA-255P  
Casters

- |  |                       |   |                     |
|--|-----------------------|---|---------------------|
| <b>SU-255</b> Add Casters to Food Units w/Undershelf (Includes 4 - 5" Swivel Casters, 2 w/ Brakes & Legs that maintain height)     | <b>\$375 Set of 4</b> | <b>SU-19</b> Prepare Hot Tables To Be Locked Together (One Charge For Each Table To Be Interlocked)   | <b>\$513 ea.</b>    |
| <b>TA-255P</b> Add Casters to Enclosed Base Food Units (Includes 4-5" Bolted Swivel Casters, 2 w/ Brakes)                          | <b>606 Set of 4</b>   | <b>SU-32</b> Upgrade to a Stainless Steel Lining (For Electric Units. Excludes Sealed Hot Well Units) | <b>115 per well</b> |
| <b>SU-5G</b> Replacement Galvanized legs with Bullet Foot For Hot/Ice Cooled Table with Undershelf (HF, SW, WB, STU or CPU Series) | <b>66 ea.</b>         | <b>SP-A</b> Aluminum Spillage Pan   | <b>119 ea.</b>      |
| <b>TCB-OMIT</b> Remove Poly Cutting Board & Shelf  | <b>-200 ea.</b>       | <b>SP-S</b> Stainless Steel Spillage Pan  | <b>209 ea.</b>      |
| <b>CB-OMIT</b> Remove Poly Cutting Board Only  | <b>-100 ea.</b>       | <b>SU-72</b> Upgrade 240 volt units to 3-Phase Wiring   | <b>448 ea.</b>      |

new

# HOT FOOD TABLES

## Electric Sealed Well Hot Food Tables



- Stainless Steel Body & Top
- Galvanized Legs, Undershelf & Adjustable Bullet Feet
- Enclosed Base Units Include Stainless Steel Body & Shelf
- Stainless Steel Lining
- Fiberglass Insulation Between Each Compartment
- Drains With Gate Valves Per Well

- 8" Wide Poly Cutting Board Shelf - Ships K.D.
- 6 Ft. Electric Cord w/ Plug Included
- Infinite Control Knobs & Indicator Lights
- Single Phase Wiring (Upgrade to 3 Phase Wiring for 240 Volt Units- **Model # SU-72 - \$448**)



Sealed Well with Drain Shown

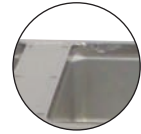

Individual Sealed Well Compartments

### Undershelf

Model #	Price	Length	Width*	# of Wells	Volts	Amps	Watts	NEMA Plug	Wt.	Cu. Ft.
SW-2E-120	\$2400	31-13/16"	30-5/8"	2	120	10.67	1280	5-20P	92 lbs.	28
SW-3E-120	2881	47-1/8"	30-5/8"	3	120	16	1920	5-20P	135 lbs.	55
SW-4E-120	4063	62-7/16"	30-5/8"	4	120	21.33	2560	L5-30P	230 lbs.	55
SW-2E-240	2400	31-13/16"	30-5/8"	2	208/240	7.94/9.16	1650/2200	6-20P	92 lbs.	28
SW-3E-240	2881	47-1/8"	30-5/8"	3	208/240	11.91/13.74	2475/3300	6-20P	135 lbs.	41
SW-4E-240	4063	62-7/16"	30-5/8"	4	208/240	15.88/18.32	3300/4400	L6-30P	230 lbs.	55
SW-5E-240	5047	77-3/4"	30-5/8"	5	208/240	19.85/22.90	4125/5500	L6-30P	220 lbs.	67

\*Width Includes 8" Cutting Board

See Below For Stainless Steel Legs & Undershelf Upgrade



w/ Undershelf  
SW-3E-120 Shown

### Enclosed Base

Model #	Price	Length	Width*	# of Wells	Volts	Amps	Watts	NEMA Plug	Wt.	Cu. Ft.
SW-2E-120-BS	\$4494	31-13/16"	30-5/8"	2	120	10.67	1280	5-20P	127 lbs.	28
SW-3E-120-BS	5162	47-1/8"	30-5/8"	3	120	16	1920	5-20P	155 lbs.	41
SW-4E-120-BS	6345	62-7/16"	30-5/8"	4	120	21.33	2560	L5-30P	197 lbs.	54
SW-2E-240-BS	4494	31-13/16"	30-5/8"	2	208/240	7.94/9.16	1650/2200	6-20P	127 lbs.	28
SW-3E-240-BS	5162	47-1/8"	30-5/8"	3	208/240	11.91/13.74	2475/3300	6-20P	155 lbs.	41
SW-4E-240-BS	6345	62-7/16"	30-5/8"	4	208/240	15.88/18.32	3300/4400	L6-30P	197 lbs.	55
SW-5E-240-BS	7479	77-3/4"	30-5/8"	5	208/240	19.85/22.90	4125/5500	L6-30P	215 lbs.	67

\*Width Includes 8" Cutting Board



Enclosed Base  
SW-5E-240-BS Shown  
with Optional TA-255P Casters

### Enclosed Base w/ Sliding Doors

Model #	Price	Length	Width*	# of Wells	Volts	True Amps/ Watts Per Unit	NEMA Plug	Wt.	Cu. Ft.
SW-2E-120-DR	\$4988	31-13/16"	30-5/8"	2	120	10.67/1280	5-20P	157 lbs.	28
SW-3E-120-DR	6102	47-1/8"	30-5/8"	3	120	16/1920	5-20P	145 lbs.	41
SW-4E-120-DR	7496	62-7/16"	30-5/8"	4	120	21.33/2560	L5-30P	187 lbs.	54
SW-2E-240-DR	4988	31-13/16"	30-5/8"	2	208/240	9.17/2200	6-20P	157 lbs.	28
SW-3E-240-DR	6102	47-1/8"	30-5/8"	3	208/240	13.75/3300	6-20P	145 lbs.	41
SW-4E-240-DR	7496	62-7/16"	30-5/8"	4	208/240	18.33/4400	L6-30P	260 lbs.	54
SW-5E-240-DR	8103	77-3/4"	30-5/8"	5	208/240	22.92/5500	L6-30P	281 lbs.	67

\*Width Includes 8" Cutting Board



w/ Sliding Doors  
SW-5E-240-DR Shown

NOTE: Units are not designed to cook or heat frozen or refrigerated foods. Food placed in tables should already be hot, and the table will maintain the proper temperatures

## Food Shields & Accessories

For Our Full Line Of Hot Food Table Modifications, Accessories & Replacement Parts, See Page 131-134

**Stainless Steel Legs & Undershelf Upgrade \$659**

2 Wells	3 Wells	4 Wells	5 Wells
SU-23A	SU-23B	SU-23C	SU-23D

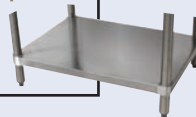

SP-S  
Spillage Pan



TA-255P  
Casters

-T Thermostatic Control (Per Well) **\$203 ea.**

-M Manifold Drains (Per Well) **230 ea.**

**SU-25S** Add Casters to Food Units w/Undershelf **375 Set of 4**  
(Includes 4 - 5" Swivel Casters, 2 w/ Brakes & Legs that maintain height)

**TA-255P** Add Casters to Enclosed Base Food Units (Includes 4 - 5" Bolted Swivel Casters, 2 w/ Brakes) **606 Set of 4**

**SU-5G** Replacement Galvanized Legs with Bullet Foot For Hot/Ice Cooled Table with Undershelf **66 ea.**  
(HF, SW, WB, STU or CPU Series)

**SU-32G** Upgrade to a Stainless Steel Lining **115 per well**  
(For Gas Units. Excludes Wetbath Units)

**K-49** Filler Faucet for Hot Tables **\$353 ea.**  
(Hot water supply only. Requires -M Manifold Drain & SU-15 Prepare for Filler Faucet Provision)

**SU-15** Prepare Hot food Table For Filler Faucet **691 ea.**  
(For Gas Units. Excludes Wetbath Units)

**SP-A** Aluminum Spillage Pan **119 ea.**

**SP-S** Stainless Steel Spillage Pan **209 ea.**

**TCB-OMIT** Remove Poly Cutting Board & Shelf **-200 ea.**

**CB-OMIT** Remove Poly Cutting Board Only **-100 ea.**



# HOT FOOD TABLES

## Gas Powered Hot Food Tables

### For Use with Optional Spillage Pans

- These Units Are Designed For Dry Operation Only.
- Stainless Steel Body & Top
- Galvanized Legs, Undershelf & Adjustable Bullet Feet
- Enclosed Base Units Include Stainless Steel Body & Shelf
- Galvanized Liner. (Optional Stainless Steel Liner upgrade available **Model # SU-32G \$115 per well**)
- 3500 BTU'S Per burner
- Fiberglass Insulation Between Each Compartment
- 8" Wide Poly Cutting Board Shelf - Ships K.D.
- Pilot Indicator Openings
- 1/2" Female NPT Connection To Regulator
- Infinite Control Knobs

Available For Natural Gas (NAT) Or Bottled Gas (LP)

### Undershelf



w/ Undershelf  
HF-3G-NAT Shown

Model #	Price	Length	Width*	# of Wells	Approx. Weight	Approx. Cu. Ft.
HF-2G-NAT or LP	\$2060	31-13/16"	30-5/8"	2	92 lbs.	28
HF-3G-NAT or LP	2293	47-1/8"	30-5/8"	3	130 lbs.	41
HF-4G-NAT or LP	2785	62-7/16"	30-5/8"	4	165 lbs.	55
HF-5G-NAT or LP	3429	77-3/4"	30-5/8"	5	170 lbs.	67

\*Width Includes 8" Cutting Board

For Stainless Steel Legs & Undershelf Upgrade See Page 118

### Enclosed Base



Enclosed Base  
HF-5G-LP-BS Shown  
with Optional TA-255P Casters

Model #	Price	Length	Width*	# of Wells	Approx. Weight	Approx. Cu. Ft.
HF-2G-NAT or LP-BS	\$3573	31-13/16"	30-5/8"	2	117 lbs.	28
HF-3G-NAT or LP-BS	4129	47-1/8"	30-5/8"	3	145 lbs.	41
HF-4G-NAT or LP-BS	5061	62-7/16"	30-5/8"	4	205 lbs.	55
HF-5G-NAT or LP-BS	5794	77-3/4"	30-5/8"	5	250 lbs.	67

\*Width Includes 8" Cutting Board

**SU-19** Prepare Hot Tables to be Locked Together **\$513 ea.**  
(One Charge For Each Table To Be Interlocked)

**NOTE:** External pressure regulator is required. 4" WC pressure in for Natural Gas and 10" WC pressure in for LP.

**NOTE:** Units are not designed to cook or heat frozen or refrigerated foods. Food placed in tables should already be hot, and the table will maintain the proper temperatures

## Sleek Shields™

### GLASS FOOD SHIELDS

Mounts To Top Of Hot/Cold Food Table

#### Self-Serve Style

- 18" Standard Height (Top of Table To Top)
- 1" Stainless Steel Tubing Posts (1 5/8" Posts Also Available)
- Includes Two 18" W x 15 3/8" H Glass Side Panels
- 1/4" Thick Heat-Tempered Glass Front & Sides
- Shipped KD



**Includes TA-47 Mounting Brackets**  
For In-Field Installation



**Chamber Lock™**  
Allows Front Glass To Lock In Place At 15° Intervals



NSG-15-4WELL Shown

15" Wide Stainless Steel Shelf			15" Wide w/ Glass Top			Fits # of Bowls	Approx. Wt.	Approx. Cubes
Model #	Price	O.A. Size L x W x H	Model #	Price	O.A. Size L x W x H			
NSG-15-2WELL	\$3134	33 9/16" x 19 3/4" x 18 1/2"	GSG-15-2WELL	\$3761	34 9/16" x 19 3/4" x 18"	Fits 2-Well Unit	109 lbs.	15
NSG-15-3WELL	3263	47 7/8" x 19 3/4" x 18 1/2"	GSG-15-3WELL	3902	49 7/8" x 19 3/4" x 18"	Fits 3-Well Unit	143 lbs.	22
NSG-15-4WELL*	3819	64 3/16" x 19 3/4" x 18 1/2"	GSG-15-4WELL*	4151	65 3/16" x 19 3/4" x 18"	Fits 4-Well Unit	189 lbs.	29
NSG-15-5WELL**	4171	78 1/2" x 19 3/4" x 18 1/2"		Not Available	Not Available	Fits 5-Well Unit	215 lbs.	38

GSG Series Food Shields are slightly longer than the table they rest on. They will extend about 7/8" on either end  
\*3/8" Thick Heat-Tempered Glass Required For Front Glass \*\*Requires a Single Center Post (Factory Print Included)

For Full Line Of Food Table Accessories,  
See Page 131-134.



# HOT FOOD TABLES

## Gas Powered Wetbath Tables



- Stainless Steel Body & Top
- Galvanized Legs, Undershef & Adjustable Bullet Feet
- Enclosed Base Units Include Stainless Steel Body & Shelf
- Stainless Steel Liner
- Stainless Steel Dish Shelf
- 8" Wide Poly Cutting Board Shelf - Ships K.D.

- 1/2" Female NPT Connection To Regulator
- Pilot Indicator Openings
- Infinite Control Knobs
- **2 & 3 Comp:** 15,000 BTU's
- **4 & 5 Comp:** 25,000 BTU's

### Filler Faucet K-49 \$353



- Hot Water Supply Only
- Requires **-M** Manifold Drain Assembly & **SU-15** Filler Faucet Provision
- Faucet Location To Be Specified When Ordering

Available For Natural Gas (NAT) Or Bottled Gas (LP)

## Undershef

Model #	Price	Length	Width*	# of Wells	Approx. Weight	Approx. Cu. Ft.
WB-2G-NAT or LP	\$2574	31-13/16"	30-5/8"	2	96 lbs.	28
WB-3G-NAT or LP	2815	47-1/8"	30-5/8"	3	130 lbs.	41
WB-4G-NAT or LP	3252	62-7/16"	30-5/8"	4	157 lbs.	55
WB-5G-NAT or LP	3825	77-3/4"	30-5/8"	5	176 lbs.	67



See Below For Stainless Steel Legs & Undershef Upgrade

## Enclosed Base

Model #	Price	Length	Width*	# of Wells	Approx. Weight	Approx. Cu. Ft.
WB-2G-NAT or LP-BS	\$4109	31-13/16"	30-5/8"	2	145 lbs.	28
WB-3G-NAT or LP-BS	4412	47-1/8"	30-5/8"	3	175 lbs.	41
WB-4G-NAT or LP-BS	4931	62-7/16"	30-5/8"	4	225 lbs.	55
WB-5G-NAT or LP-BS	5516	77-3/4"	30-5/8"	5	296 lbs.	67



\*Width Includes 8" Cutting Board

NOTE: External pressure regulator is required. 4" WC pressure in for Natural Gas and 10" WC pressure in for LP.

NOTE: Units are not designed to cook or heat frozen or refrigerated foods. Food placed in tables should already be hot, and the table will maintain the proper temperatures

## Food Table Modifications & Accessories

For Our Full Line Of Hot Food Table Modifications, Accessories & Replacement Parts, See Page 131-134

### Stainless Steel Legs & Undershef Upgrade \$659

2 Wells	3 Wells	4 Wells	5 Wells
SU-23A	SU-23B	SU-23C	SU-23D

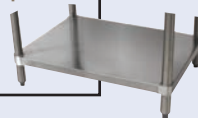

15" Height

### 10" Wide Serving Shelf with Built-In Food Shield

Model	Price	Length	Approx. Wt.	Cu. Ft.
TSS-2	\$976	31-13/16"	15 lbs.	3
TSS-3	1110	47-1/8"	17 lbs.	4
TSS-4	1211	62-7/16"	19 lbs.	5
TSS-5	1302	77-3/4"	21 lbs.	6

**SU-15** Prepare Hot Food Table for Filler Faucet (Faucet Not Included. Stationary Models Only) **\$691 ea.**

**SU-19** Prepare Hot Tables To Be Locked Together (One Charge For Each Table To Be Interlocked) **513 ea.**

**SU-25S** Add Casters to Food Units w/Undershef **375 Set of 4**  
(Includes 4 -5" Swivel Casters, 2 w/ Brakes)

**TA-255P** Add Casters to Enclosed Base Food Units (Includes 4 -5" Bolted Swivel Casters, 2 w/ Brakes) **606 Set of 4**

**SU-5G** Replacement Galvanized Legs with Bullet Foot For Hot/Ice Cooled Table with Undershef **66 ea.**  
(HF, SW, WB, STU or CPU Series)

**SU-45A** 12" x 1" Adapter Bar **52 ea.**

**SU-45B** 20" x 3" Adapter Bar **58 ea.**

**SP-A** Aluminum Spillage Pan **119 ea.**

**SP-S** Stainless Steel Spillage Pan **209 ea.**

**TCB-OMIT** Remove Poly Cutting Board & Shelf **-200 ea.**

**CB-OMIT** Remove Poly Cutting Board Only **-100 ea.**

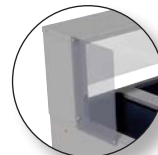

### Acrylic Side Panel for Serving Shelf

Add side panels to meet additional NSF requirements (1 panel per side)

**TSP-1** \$247 One End

**TSP-2** \$493 Two Ends

Field Installation Available

# SOLID FOOD TABLES

## Solid Top Tables

- Stainless Steel Body & Top
- Galvanized Legs, Undershaft & Adjustable Bullet Feet
- Enclosed Base Units Include Stainless Steel Body & Shelf
- 8" Wide Poly Cutting Board Shelf - Ships K.D.



w/Undershaft  
STU-3 Shown



Enclosed Base  
STU-3-BS Shown



w/ Doors  
STU-5-DR Shown

### Undershaft

Model #	Price	Length	Width*	Wt.	Cu. Ft.
STU-2	\$1288	31-13/16"	30-5/8"	90 lbs.	12
STU-3	1498	47-1/8"	30-5/8"	118 lbs.	17
STU-4	1777	62-7/16"	30-5/8"	150 lbs.	23
STU-5	2238	77-3/4"	30-5/8"	168 lbs.	41

\*Width Includes 8" Cutting Board

For Stainless Steel Legs & Undershaft Upgrade See Page 120

### Enclosed Base

Model #	Price	Length	Width*	Wt.	Cu. Ft.
STU-2-BS	\$4174	31-13/16"	30-5/8"	115 lbs.	26
STU-3-BS	4405	47-1/8"	30-5/8"	143 lbs.	36
STU-4-BS	5222	62-7/16"	30-5/8"	185 lbs.	46
STU-5-BS	5823	77-3/4"	30-5/8"	203 lbs.	56

\*Width Includes 8" Cutting Board

### w/ Doors

Model #	Price	Length	Width*	Wt.	Cu. Ft.
STU-2-DR	\$4522	31-13/16"	30-5/8"	125 lbs.	26
STU-3-DR	6107	47-1/8"	30-5/8"	153 lbs.	36
STU-4-DR	5695	62-7/16"	30-5/8"	195 lbs.	46
STU-5-DR	6656	77-3/4"	30-5/8"	213 lbs.	56

\*Width Includes 8" Cutting Board

SU-19 Prepare Hot Tables to be Locked Together **\$513 ea.**

(One Charge For Each Table To Be Interlocked)

TCB-OMIT Remove Poly Cutting Board & Shelf **-200 ea.**

CB-OMIT Remove Poly Cutting Board Only **-100 ea.**

## Food Table Overshelves

For Our Full Line Of Hot Food Table Modifications, Accessories & Replacement Parts, See Page 131-134



Single Overshelves



Double Overshelves

12" WIDE					18" WIDE					12" WIDE					18" WIDE				
Model	Price	Approx Wt.	Model	Price	Length	Approx Wt.	Cu. Ft.	Model	Price	Approx Wt.	Model	Price	Length	Approx Wt.	Cu. Ft.				
STOS-2	\$784	18 lbs.	STOS-2-18	\$997	31-13/16"	20 lbs.	3	TOS-2	\$1423	32 lbs.	TOS-2-18	\$1691	31-13/16"	35 lbs.	3				
STOS-3	890	21 lbs.	STOS-3-18	1074	47-1/8"	23 lbs.	4	TOS-3	1662	38 lbs.	TOS-3-18	1952	47-1/8"	56 lbs.	4				
STOS-4	1003	24 lbs.	STOS-4-18	1163	62-7/16"	26 lbs.	5	TOS-4	1898	44 lbs.	TOS-4-18	2231	62-7/16"	66 lbs.	5				
STOS-5	1086	27 lbs.	STOS-5-18	1269	77-3/4"	30 lbs.	6	TOS-5	2135	49 lbs.	TOS-5-18	2504	77-3/4"	76 lbs.	6				

# COLD WELL DROP-INS

## Drop-In Cold Pan Units

### ICE-COOLED DROP-IN COLD PAN UNITS



- 304 Stainless Steel Top
- 9" Deep Ice Bin With Fiberglass Insulation

- Black Molding with Thermal Breaker
- 1" I.P.S. Drain

	Model #	Price	Length	Width	Cut-Out Size	Ice Capacity	Approx. Wt.	Cu. Ft.
SLIMLINE	DISLCP-2	\$2221	47-9/16"	16-1/2"	15-1/8" x 45-7/8"	93	46 lbs.	11
	DISLCP-3	2682	70-3/8"	16-1/2"	15-1/8" x 68-3/4"	141	58 lbs.	18
	DISLCP-4	3062	93-3/16"	16-1/2"	15-1/8" x 91-1/2"	186	70 lbs.	23
STANDARD	DICP-1	1542	18-13/16"	26-3/4"	23-3/8" x 17-1/4"	45	85 lbs.	6
	DICP-2	1828	34-1/8"	26-3/4"	23-3/8" x 32-5/8"	93	88 lbs.	10
	DICP-3	2096	49-7/16"	26-3/4"	23-3/8" x 47-7/8"	141	110 lbs.	14
	DICP-4	2607	64-3/4"	26-3/4"	23-3/8" x 63-1/4"	188	132 lbs.	18
	DICP-5	3009	80-1/8"	26-3/4"	23-3/8" x 78-1/2"	236	154 lbs.	23
	DICP-6	3313	95-3/8"	26-3/4"	23-3/8" x 93-7/8"	284	176 lbs.	27



**Slimline**  
DISLCP-3 Shown



**Standard**  
DICP-2 Shown

**SU-45A** 12" x 1" Adapter Bars **\$49 ea.**

**SU-45B** 20" x 3" Adapter Bars **\$55 ea.**

### REFRIGERATED DROP-IN COLD PAN UNITS

- 304 Stainless Steel Top
- 9" Deep Ice Bin With Fiberglass Insulation
- Full Insulation Galvanized Outer Jacket
- Black Molding with Thermal Breaker
- High Cooling Capacity
- Sight Glass To Ensure Properly Charges System
- Low Running Current

- 1" I.P.S. Drain
- Precision Thermostat For Exact Temperature Control
- Includes Adapter Bars For 12" X 20" Food Pans (Pans not Included)
- Cord & Plug Included



**Slimline**  
DISLRCP-2 Shown

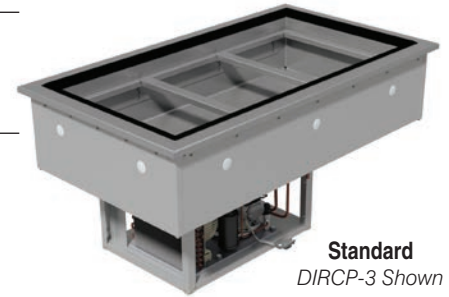

**Standard**  
DIRCP-3 Shown

	Model #	Price	Length	Width	Cut-Out Size	# of Wells	Refrigerant	Approx. Wt.	Cu. Ft.
SLIMLINE	DISLRCP-2	\$5924	49-5/8"	18-5/8"	17-1/8" x 48-3/8"	2	R404-A	205 lbs.	25
	DISLRCP-3	6653	71-1/4"	18-5/8"	15-3/8" x 70"	3	R404-A	257 lbs.	31
	DISLRCP-4	7393	92-7/8"	18-5/8"	17-3/8" x 91-5/8"	4	R404-A	325 lbs.	46
STANDARD	DIRCP-1	4491	20"	26-3/4"	25-1/2" x 18-5/8"	1	R404-A	163 lbs.	14
	DIRCP-2	4801	33-1/2"	26-3/4"	25-1/2" x 32-1/8"	2	R404-A	205 lbs.	22
	DIRCP-3	5271	47"	26-3/4"	25-1/2" x 45-5/8"	3	R404-A	257 lbs.	31
	DIRCP-4	5871	60-1/2"	26-3/4"	25-1/2" x 59-1/8"	4	R404-A	325 lbs.	39
	DIRCP-5	6880	74"	26-3/4"	25-1/2" x 72-5/8"	5	R404-A	365 lbs.	47
	DIRCP-6	7376	87-1/2"	26-3/4"	25-1/2" x 86-1/8"	6	R404-A	398 lbs.	55

**SU-71** 5 Year Extended Parts Warranty on Refrigeration Unit **\$461 Per Unit**  
(Available for Refrigerated Tables & Drop-Ins. See Back Inside Cover For Full Details)



**SU-P-234** - 6' Cord with  
**NEMA 5-15P** plug Included

**NOTE: Units are not designed to cool foods originally warm. Food should already be chilled to maintain the proper temperatures**



# COLD FOOD TABLES

## Standard Ice-Cooled Tables

- 304 Stainless Steel Body & Top
- Galvanized Legs, Undershef & Adjustable Bullet Feet
- Enclosed Base Units Include Stainless Steel Body & Shelf
- Fiberglass Insulation
- 1" I.P.S. Drain
- 8" Wide Poly Cutting Board Shelf - Ships K.D.

### Undershef

Model #	Price	Length	Width*	Wt.	Cu. Ft.
CPU-2	\$1457	31-13/16"	30-5/8"	90 lbs.	12
CPU-3	1886	47-1/8"	30-5/8"	118 lbs.	18
CPU-4	2284	62-7/16"	30-5/8"	150 lbs.	23
CPU-5	2686	77-3/4"	30-5/8"	168 lbs.	29

\*Width Includes 8" Cutting Board

### Stainless Steel Legs & Undershef Upgrade \$659

2 Wells	3 Wells	4 Wells	5 Wells
SU-23A	SU-23B	SU-23C	SU-23D



**SU-5G** Replacement Galvanized Legs with Bullet Foot For Hot/Ice Cooled Table with Undershef (HF, SW, WB, STU or CPU Series) **66 ea.**



w/ Undershef  
CPU-3 Shown



Enclosed Base  
CPU-5-BS Shown  
with Optional Caster Kit

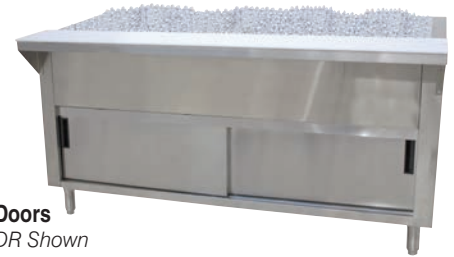

W/ Doors  
CPU-5-DR Shown

### Enclosed Base

Model #	Price	Length	Width*	Wt.	Cu. Ft.
CPU-2-BS	\$3620	31-13/16"	30-5/8"	115 lbs.	18
CPU-3-BS	4293	47-1/8"	30-5/8"	143 lbs.	34
CPU-4-BS	5078	62-7/16"	30-5/8"	227 lbs.	44
CPU-5-BS	5363	77-3/4"	30-5/8"	203 lbs.	54

\*Width Includes 8" Cutting Board

### w/ Doors

Model #	Price	Length	Width*	Wt.	Cu. Ft.
CPU-2-DR	\$3815	31-13/16"	30-5/8"	125 lbs.	24
CPU-3-DR	4573	47-1/8"	30-5/8"	153 lbs.	34
CPU-4-DR	5481	62-7/16"	30-5/8"	195 lbs.	44
CPU-5-DR	5834	77-3/4"	30-5/8"	213 lbs.	54

\*Width Includes 8" Cutting Board

**NOTE: Units are not designed to cool foods originally warm. Food should already be chilled to maintain the proper temperatures**



### CONNECT IT!

Prepare Tables To Be Locked Together While Keeping Them Lined Up!  
(One Charge For Each Table To Be Interlocked)  
**SU-19 \$513 per table**

## Sleek Shields™

Protected By: Patent No. US 9,010,883 B2

### Self-Serve Style

- 18" Standard Height (Top of Table To Top)
- 1" Stainless Steel Tubing Posts (1 5/8" Posts Also Available)
- Includes Two 18" W x 15 3/8" H Glass Side Panels
- 1/4" Thick Heat-Tempered Glass Front & Sides
- Shipped KD

## GLASS FOOD SHIELDS

Mounts To Top Of Hot/Cold Food Table



Includes TA-47 Mounting Brackets For In-Field Installation



Chamber Lock™ Allows Front Glass To Lock In Place At 15° Intervals



NSG-15-4WELL Shown

15" Wide Stainless Steel Shelf			15" Wide w/ Glass Top			Fits # of Bowls	Approx. Wt.	Approx. Cubes
Model #	Price	O.A. Size L x W x H	Model #	Price	O.A. Size L x W x H			
NSG-15-2WELL	\$3134	33 9/16" x 19 3/4" x 18 1/2"	GSG-15-2WELL	\$3761	34 9/16" x 19 3/4" x 18"	Fits 2-Well Unit	67 lbs.	5
NSG-15-3WELL	3263	47 7/8" x 19 3/4" x 18 1/2"	GSG-15-3WELL	3902	49 7/8" x 19 3/4" x 18"	Fits 3-Well Unit	72 lbs.	6
NSG-15-4WELL*	3819	64 3/16" x 19 3/4" x 18 1/2"	GSG-15-4WELL*	4151	65 3/16" x 19 3/4" x 18"	Fits 4-Well Unit	80 lbs.	10
NSG-15-5WELL††	4171	78 1/2" x 19 3/4" x 18 1/2"	Not Available	Not Available	Not Available	Fits 5-Well Unit	88 lbs.	10

GSG Series Food Shields are slightly longer than the table they rest on. They will extend about 7/8" on either end

\*3/8" Thick Heat-Tempered Glass Required For Front Glass

††Requires a Single Center Post (Factory Print Included)

For Full Line Of Food Table Accessories, See Page 131-134.



# COLD FOOD TABLES

## Mechanically Assisted Cold Pan Tables



### REFRIGERATED COLD PAN TABLES

- 304 Stainless Steel Body, Top and Legs
- Adjustable Bullet Feet
- Heavy Duty Cabinet Base
- 8" Wide Poly Cutting Board Shelf - Ships K.D.
- 1" I.P.S. Drain
- Precision Thermostat For Exact Temperature Control
- High Cooling Capacity
- Sight Glass To Ensure Properly Charges System
- Low Running Current



**Enclosed Base**  
MACP-3-BS Shown



**Sliding Doors**  
MACP-3-DR Shown



**SU-P-234** - 6' Cord with  
**NEMA 5-15P** plug Included

#### Enclosed Base

Model #	Price	Length	Width*	Refrigerant	Wt.	Cu. Ft.
MACP-2-BS	\$8926	31-3/16"	30-5/8"	R404-A	230 lbs.	39
MACP-3-BS	10078	47-1/8"	30-5/8"	R404-A	256 lbs.	56
MACP-4-BS	10891	62-7/16"	30-5/8"	R404-A	380 lbs.	73
MACP-5-BS	11884	77-3/4"	30-5/8"	R404-A	465 lbs.	90

\*Width Includes 8" Cutting Board

#### w/ Sliding Doors

Model #	Price	Length	Width*	Refrigerant	Wt.	Cu. Ft.
MACP-3-DR	\$10460	47-1/8"	30-5/8"	R404-A	385 lbs.	41
MACP-4-DR	12111	62-7/16"	30-5/8"	R404-A	420 lbs.	73
MACP-5-DR	13261	77-3/4"	30-5/8"	R404-A	505 lbs.	90

\*Width Includes 8" Cutting Board

**SU-71** 5 Year Extended Parts Warranty on Refrigeration Unit **\$461 Per Unit**  
(Available for Refrigerated Tables & Drop-Ins. See Back Inside Cover For Full Details)

#### Cold Pan Table Covers

- Stainless Steel
- Plastic Handles
- Piano Hinge(s)
- Fits CPU, DICP  
MACP & BMACP  
Units

Model #	Price	Length	Wt.	Cu. Ft.
HC-2	\$348	28-9/16"	12 lbs.	3
HC-3	521	43-7/8"	16 lbs.	4
HC-4	571	59-3/16"	20 lbs.	5
HC-5	663	74-1/2"	24 lbs.	6

**NOTE: Units are not designed to cool foods originally warm. Food should already be chilled to maintain the proper temperatures**

**WARNING:** Refrigerated Equipment on this page may expose you to chemicals, including Ethanes, that are known to the State of California to cause cancer or birth defects or other reproductive harm. For more Info., visit [www.p65warnings.ca.gov](http://www.p65warnings.ca.gov).

## Food Table Shelving

For Our Full Line Of Hot Food Table Modifications, Accessories & Replacement Parts, See Page 131-134



15" Height

#### Single Overshelves



12" Height  
15" Height

#### Double Overshelves

12" WIDE				18" WIDE				12" WIDE				18" WIDE					
Model	Price	Approx Wt.		Model	Price	Length	Approx Wt.	Cu. Ft.	Model	Price	Approx Wt.		Model	Price	Length	Approx Wt.	Cu. Ft.
STOS-2	\$784	18 lbs.		STOS-2-18	\$997	31-13/16"	20 lbs.	3	TOS-2	\$1423	32 lbs.		TOS-2-18	\$1691	31-13/16"	35 lbs.	3
STOS-3	890	21 lbs.		STOS-3-18	1074	47-1/8"	23 lbs.	4	TOS-3	1662	38 lbs.		TOS-3-18	1952	47-1/8"	56 lbs.	4
STOS-4	1003	24 lbs.		STOS-4-18	1163	62-7/16"	26 lbs.	5	TOS-4	1898	44 lbs.		TOS-4-18	2231	62-7/16"	66 lbs.	5
STOS-5	1086	27 lbs.		STOS-5-18	1269	77-3/4"	30 lbs.	6	TOS-5	2135	49 lbs.		TOS-5-18	2504	77-3/4"	76 lbs.	6

## Food Table Accessories

- SU-255** Add Casters to Food Units w/Undershelf **\$375 Set of 4**  
(Includes 4 - 5" Bolted Swivel Casters, 2 w/ Brakes)
- SU-25** Add Casters to Food Units w/Undershelf **375 Set of 4**  
(For Units Built Before October 2015. Includes 4 - 5" Swivel Casters, 2 w/ Brakes.)
- TA-25** Replacement Casters For Undershelf Units **375 Set of 4**  
(For Units Built After October 2015. Includes 4 - 5" Swivel Casters, 2 w/ Brakes.)
- TA-255P** Add Casters to Enclosed Base Food Units **606 Set of 4**  
(Includes 4 - 5" Bolted Swivel Casters, 2 w/ Brakes)
- SU-19** Prepare Hot Tables to be Locked Together **\$513 ea.**  
(One Charge For Each Table To Be Interlocked)
- SU-45A** 12" x 1" Adapter Bar **52 ea.**
- SU-45B** 20" x 3" Adapter Bar **58 ea.**
- TCB-OMIT** Remove Poly Cutting Board & Shelf **-200 ea.**
- CB-OMIT** Remove Poly Cutting Board Only **-100 ea.**

**Sleek Shields™ Are Also Available For Hot & Cold Food Tables. See Pages 130 For Details.**

# HEAVY DUTY TABLES

## Heavy Duty Tables

### HEAVY DUTY ELECTRIC SEALED WELL TABLES

- Heavy Duty Construction 300 Stainless Steel Body, Top and Legs
- Adjustable Stainless Steel Bullet Feet
- 8" Wide Poly Cutting Board Shelf - Ships K.D.
- Sealed Wells w/ Manifold Drains
- Thermostatic Controls
- 6 Ft. Electric Cord w/ Plug Included
- Control Knobs & Indicator Lights
- Removable Front Panel To Access Elements (Upgrade to 3 Phase Wiring for 240 Volt Units- **Model # SU-72 - \$448**)



**Enclosed Base**  
HDSW-3-240-BS Shown  
with Optional TA-255P Casters

#### Enclosed Base

Model #	Price	Length	Width*	# of Wells	Volts	Amps	Watts	Wt.	Cu. Ft.
HDSW-2-120-BS	\$8465	31-13/16"	35-3/4"	2	120	10.67	1280	225	31
HDSW-3-120-BS	10199	47-1/8"	35-3/4"	3	120	16	1920	340	45
HDSW-4-120-BS	11732	62-7/16"	35-3/4"	4	120	21.33	2560	430	60
HDSW-2-240-BS	8465	31-13/16"	35-3/4"	2	208/240	7.94/9.16	1650/2200	225	31
HDSW-3-240-BS	10199	47-1/8"	35-3/4"	3	208/240	11.91/13.74	2475/3300	340	45
HDSW-4-240-BS	11732	62-7/16"	35-3/4"	4	208/240	15.88/18.32	3300/4400	430	60
HDSW-5-240-BS	15311	77-3/4"	35-3/4"	5	208/240	19.85/22.90	4125/5500	520	74
HDSW-6-240-BS	17870	93-1/8"	35-3/4"	6	208/240	23.82/27.48	4850/6600	610	88

\*Width Includes 8" Cutting Board

**NOTE: Units are not designed to cook or heat frozen or refrigerated foods. Food placed in tables should already be hot, and the table will maintain the proper temperatures**

#### Filler Faucet K-49 \$353



- Hot Water Supply Only
- Faucet Location To Be Specified When Ordering
- Requires -M Manifold Drain Assembly
- Add **SU-15 \$691** for Filler Faucet Provision

### HEAVY DUTY Refrigerated Cold Well Tables

- Heavy Duty Construction 300 Stainless Steel Body, Top & Legs
- Adjustable Stainless Steel Bullet Feet
- Heavy Duty Cabinet Base
- 1" I.P.S. Drain
- Poly Cutting Board Shelf - Ships K.D.
- High Cooling Capacity
- Includes Adapter Bars For Optional Spillage Pans
- Low Running Current
- Precision Thermostat For Exact Temperature Control
- Single Phase Wiring



**Enclosed Base**  
HDRCP-3-BS Shown  
with Optional TA-255P Casters

Model #	Price	Length	Width*	Refrigerant	Wt.	Cu. Ft.
HDRCP-2-BS	\$13137	31-13/16"	36-1/4"	R404-A	300 lbs.	39
HDRCP-3-BS	13779	47-1/8"	36-1/4"	R404-A	420 lbs.	56
HDRCP-4-BS	15311	62-1/2"	36-1/4"	R404-A	510 lbs.	73
HDRCP-5-BS	17863	77-3/4"	36-1/4"	R404-A	568 lbs.	90
HDRCP-6-BS	19649	93-3/4"	36-1/4"	R404-A	633 lbs.	90

\*Width Includes 8" Cutting Board

**SU-71** 5 Year Extended Parts Warranty on Refrigeration Unit **\$461 Per Unit**  
(Available for Refrigerated Tables & Drop-Ins. See Back Inside Cover For Full Details)



#### CONNECT IT!

Prepare Tables To Be Locked Together While Keeping Them Lined Up!  
(One Charge For Each Table To Be Interlocked)  
**SU-19 \$513 per table**

**WARNING:** Refrigerated Equipment on this page may expose you to chemicals, including Ethanes, that are known to the State of California to cause cancer or birth defects or other reproductive harm. For more Info, visit [www.p65warnings.ca.gov](http://www.p65warnings.ca.gov).

### HEAVY DUTY ICE-COOLED TABLES



- Stainless Steel Body, Top And Legs
- Adjustable Stainless Steel Bullet Feet
- High Cooling Capacity
- Heavy Duty Cabinet Base
- 8" Wide Poly Cutting Board Shelf - Ships K.D.

**Enclosed Base**  
HDCPU-3-BS Shown  
with Optional TA-255P Casters



#### Enclosed Base

Model #	Price	Length	Width*	Wt.	Cu. Ft.
HDCPU-2-BS	\$6432	31-13/16"	36-1/4"	117 lbs.	27
HDCPU-3-BS	7613	47-1/8"	36-1/4"	145 lbs.	39
HDCPU-4-BS	8232	62-1/2"	36-1/4"	205 lbs.	58
HDCPU-5-BS	10201	77-3/4"	36-1/4"	250 lbs.	69
HDCPU-6-BS	11169	93-1/8"	36-1/4"	295 lbs.	81

#### With Doors

Model #	Price	Length	Width*	Wt.	Cu. Ft.
HDCPU-2-DR	\$6643	31-13/16"	36-1/4"	127 lbs.	27
HDCPU-3-DR	8009	47-1/8"	36-1/4"	155 lbs.	39
HDCPU-4-DR	8477	62-1/2"	36-1/4"	215 lbs.	58
HDCPU-5-DR	10563	77-3/4"	36-1/4"	264 lbs.	69
HDCPU-6-DR	11621	93-1/8"	36-1/4"	309 lbs.	81

\*Width Includes 8" Cutting Board

See Pages 131-134 For Shelving & Accessories! For Shelving on 6 Well Units, Please Consult Our Smart Fabrication™ Dept.

# BUFFET TABLES

## Everyday Buffet Hot Food Tables

For Use with Optional Spillage Pans

- Stainless Steel Top And Body
- Matte Black Vinyl Clad
- 8" Deep Liners For Optional **SP-A** Or **SP-S** Spillage Pans
- 1/4" Thick, Double Sided Thermoplastic Polymer Sneeze Guard & Side Panels
- 4" Swivel Casters, Two With Brakes
- Fiberglass Insulation
- Pre-Drilled For Optional Solid Drop-Down Tray Shelf available for one or both sides

- Infinite Control Knobs
- Indicator Lights
- 6' Electrical Cord With Plug
- Single Phase Wiring (Upgrade to 3 Phase Wiring for 240 Volt Units- **Model # SU-72 \$448**)
- To Omit Sneeze Guard use **Model # BSG-OMIT** deduct \$350



**Open Base**  
B3-120-B-S Shown

### Open Base

Galvanized Liners	Price	Stainless Steel Liners	Price	Length	# of Wells	NEMA Plug	Volts	Amps	Watts	Wt.	Cu. Ft.
B2-120-B	\$3915	B2-120-B-S	\$4389	31-13/16"	2	5-20P	120	8.33	1000	135 lbs.	39
B3-120-B	4158	B3-120-B-S	4601	47-1/8"	3	5-20P	120	12.50	1500	246 lbs.	56
B4-120-B	4864	B4-120-B-S	5315	62-7/16"	4	L5-30P	120	16.67	2000	301 lbs.	73
B2-240-B	3915	B2-240-B-S	4389	31-13/16"	2	6-20P	208/240	7.21/8.33	1500/2000	135 lbs.	39
B3-240-B	4158	B3-240-B-S	4601	47-1/8"	3	6-20P	208/240	10.82/12.50	2250/3000	170 lbs.	57
B4-240-B	4864	B4-240-B-S	5315	62-7/16"	4	L6-30P	208/240	14.42/16.67	3000/4000	310 lbs.	73
B5-240-B	5997	B5-240-B-S	6283	77-3/4"	5	L6-30P	208/240	18.03/20.84	3750/5000	343 lbs.	90

### Enclosed Base

Galvanized Liners	Price	Stainless Steel Liners	Price	Length	# of Wells	NEMA Plug	Volts	Amps	Watts	Wt.	Cu. Ft.
B2-120-B-SB	\$4888	B2-120-B-S-SB	\$5124	31-13/16"	2	5-20P	120	8.33	1000	135 lbs.	39
B3-120-B-SB	5410	B3-120-B-S-SB	5766	47-1/8"	3	5-20P	120	12.50	1500	170 lbs.	56
B4-120-B-SB	5932	B4-120-B-S-SB	6532	62-7/16"	4	L5-30P	120	16.67	2000	310 lbs.	73
B2-240-B-SB	4888	B2-240-B-S-SB	5124	31-13/16"	2	6-20P	208/240	7.21/8.33	1500/2000	135 lbs.	39
B3-240-B-SB	5410	B3-240-B-S-SB	5766	47-1/8"	3	6-20P	208/240	10.82/12.50	2250/3000	170 lbs.	56
B4-240-B-SB	5932	B4-240-B-S-SB	6532	62-7/16"	4	L6-30P	208/240	14.42/16.67	3000/4000	210 lbs.	73
B5-240-B-SB	6825	B5-240-B-S-SB	7355	77-3/4"	5	L6-30P	208/240	18.03/20.84	3750/5000	235 lbs.	90



**Enclosed Base**  
B3-120-B-SB Shown

## BUFFET TABLE SEALED WELL WITH ENCLOSED BASE

- Stainless Steel Top And Body
- Stainless Steel Sealed Wells with Manifold Drains
- Matte Black Vinyl Clad
- 10 Gauge Aluminum Dome Shape Heat Element
- 20 Gauge Stainless Steel Deep Drawn Bowls With 1" Drain
- 1/4" Thick, Double Sided Thermoplastic Polymer Sneeze Guard And Side Panels
- 4" Swivel Casters, Two With Brakes
- Fiberglass Insulation

- Optional Solid Drop-Down Tray Shelf available for one or both sides
- Infinite Control Knobs
- Indicator Lights
- Single Phase Wiring
- Single Phase Wiring (Upgrade to 3 Phase Wiring for 240 Volt Units- **Model # SU-72 -\$448**)
- 6' Electrical Cord With Plug
- To Omit Sneeze Guard use **Model # BSG-OMIT** deduct \$350



**Enclosed Base**  
BSW3-120-B-SB Shown

### Enclosed Base

Stainless Steel Liners	Price	Length	# of Wells	NEMA Plug	Volts	Amps	Watts	Wt.	Cu. Ft.
BSW2-120-B-SB	\$5814	31-13/16"	2	5-20P	120	10.67	1280	300 lbs.	30
BSW3-120-B-SB	6206	47-1/8"	3	5-20P	120	16	1920	325 lbs.	43
BSW4-120-B-SB	6998	62-7/16"	4	L5-30P	120	21.33	2560	356 lbs.	55
BSW2-240-B-SB	5814	31-13/16"	2	6-20P	208/240	7.94/9.16	1650/2200	300 lbs.	30
BSW3-240-B-SB	6206	47-1/8"	3	6-20P	208/240	11.91/13.74	2475/3300	325 lbs.	43
BSW4-240-B-SB	6998	62-7/16"	4	L6-30P	208/240	15.88/18.32	3300/4400	356 lbs.	55
BSW5-240-B-SB	8166	77-3/4"	5	L6-30P	208/240	19.85/22.90	4125/5500	370 lbs.	68

**NOTE: Units are not designed to cook or heat frozen or refrigerated foods. Food placed in tables should already be hot, and the table will maintain the proper temperatures**

See Pages 131-134 For Shelving & Accessories!

### END SHELF

FOR HOT/COLD TABLES  
(Excludes HDSW, HDRCP & HDCPU Units)

- 10" Wide x 22 1/2" Length
- Stainless Steel

<b>Stationary</b>	<b>Drop-Down</b>
<b>TES-1</b>	<b>TES-1D</b>
<b>\$657</b>	<b>\$776</b>



# BUFFET TABLES

## Everyday Buffet Ice-Cooled Tables

For Use with Optional Spillage Pans

- Stainless Steel Top And Body
- Matte Black Vinyl Clad
- 8" Deep Liners With Adapter Bars For Optional **SP-A** Or **SP-S** Spillage Pans
- 1/4" Thick, Double Sided Thermoplastic Polymer Sneeze Guard And Side Panels
- 4" Swivel Casters, Two With Brakes
- Fiberglass Insulation
- Pre-Drilled For Optional Solid Drop-Down Tray Shelf available for one or both sides
- To Omit Sneeze Guard use **Model # BSG-OMIT** deduct \$350

### Open Base

Model	Price	Length	# of Wells	Wt.	Cu. Ft.
<b>B2-CPU-B</b>	<b>\$3670</b>	31-13/16"	2	225 lbs.	53
<b>B3-CPU-B</b>	<b>4015</b>	47-1/8"	3	250 lbs.	76
<b>B4-CPU-B</b>	<b>4361</b>	62-7/16"	4	310 lbs.	97
<b>B5-CPU-B</b>	<b>4995</b>	77-3/4"	5	350 lbs.	119



**Open Base**  
B3-CPU-B Shown

### Enclosed Base

Model	Price	Length	# of Wells	Wt.	Cu. Ft.
<b>B2-CPU-B-SB</b>	<b>\$4145</b>	31-13/16"	2	235 lbs.	53
<b>B3-CPU-B-SB</b>	<b>4297</b>	47-1/8"	3	260 lbs.	76
<b>B4-CPU-B-SB</b>	<b>4699</b>	62-7/16"	4	320 lbs.	97
<b>B5-CPU-B-SB</b>	<b>5434</b>	77-3/4"	5	360 lbs.	119



**Enclosed Base**  
B3-CPU-B-SB Shown

**NOTE: Units are not designed to cool foods originally warm. Food should already be chilled to maintain the proper temperatures**

## Everyday Buffet Tables with Solid Top

- Stainless Steel Top And Body
- Solid Stainless Steel Top
- Matte Black Vinyl Clad
- 1/4" Thick, Double Sided Thermoplastic Polymer Sneeze Guard on top and side panels and Side Panels
- 4" Swivel Casters, Two With Brakes
- Optional Solid Drop-Down Tray Shelf available for one or both sides
- To Omit Sneeze Guard use **Model # BSG-OMIT** deduct \$350

### Open Base

Model	Price	Length	Wt.	Cu. Ft.
<b>B2-STU-B</b>	<b>\$3795</b>	31-13/16"	260 lbs.	53
<b>B3-STU-B</b>	<b>4058</b>	47-1/8"	300 lbs.	76
<b>B4-STU-B</b>	<b>4559</b>	62-7/16"	330 lbs.	97
<b>B5-STU-B</b>	<b>5213</b>	77-3/4"	370 lbs.	119



**Open Base**  
B3-STU-B Shown

### ENCLOSED BASE

Model	Price	Length	Wt.	Cu. Ft.
<b>B2-STU-B-SB</b>	<b>\$4034</b>	31.8125"	270 lbs.	53
<b>B3-STU-B-SB</b>	<b>4557</b>	47.125"	310 lbs.	76
<b>B4-STU-B-SB</b>	<b>5082</b>	62.4375"	340 lbs.	97
<b>B5-STU-B-SB</b>	<b>5367</b>	77.75"	380 lbs.	119



**Enclosed Base**  
B3-STU-B-SB Shown

See Pages 131-134 For Shelving & Accessories!



# BUFFET TABLES

## Mechanically Assisted Everyday Buffet Tables

For Use with Optional Spillage Pans



### COLD PAN TABLES WITH ENCLOSED BASE

- Stainless Steel Top, Liner And Body
- Self contained condensing unit provided with a hermetically sealed compressor with a digital, programmable thermostat
- Full Insulation With 22 Gauge Galvanized Outer Jacket
- Removable access door to compressor
- Fiberglass Insulation
- High Cooling Capacity
- Sight Glass To Ensure Properly Charges System
- Low Running Current
- Precision Thermostat For Exact Temperature Control
- 1" I.P.S. Drain
- 1/4" Thick, Double Sided Thermoplastic Polymer Sneeze Guard And Side Panels
- 4" Swivel Casters, Two With Brakes
- Includes Food Pan Adapters For optional 12" X 20" Pans
- Matte Black Vinyl Clad
- Pre-Drilled For Optional Solid Drop-Down Tray Shelf available for one or both sides
- Single Phase Wiring
- 6' Electrical Cord With Plug
- To Omit Sneeze Guard use **Model # BSG-OMIT** deduct \$350



**Enclosed Base**  
BMACP3-B-SB Shown

Model	Price	Length	# of Wells	NEMA Plug	Refrigerant	Wt.	Cu. Ft.
BMACP2-B-SB	\$9322	31-13/16"	2	5-20P	R404-A	250 lbs.	30
BMACP3-B-SB	9962	47-1/8"	3	5-20P	R404-A	300 lbs.	43
BMACP4-B-SB	10475	62-7/16"	4	5-20P	R404-A	345 lbs.	55
BMACP5-B-SB	11155	77-3/4"	5	5-20P	R404-A	395 lbs.	68

**NOTE:** Units are not designed to cook or heat frozen or refrigerated foods. Food placed in tables should already be hot, and the table will maintain the proper temperatures

**SU-71** 5 Year Extended Parts Warranty on Refrigeration Unit **\$461 Per Unit**  
(Available for Refrigerated Tables & Drop-Ins. See Back Inside Cover For Full Details)



**CONNECT IT!**  
Prepare Tables To Be Locked Together While Keeping Them Lined Up!  
(One Charge For Each Table To Be Interlocked)  
**SU-19** \$513 per table

**WARNING:** Refrigerated Equipment on this page may expose you to chemicals, including Ethanes, that are known to the State of California to cause cancer or birth defects or other reproductive harm. For more Info., visit [www.p65warnings.ca.gov](http://www.p65warnings.ca.gov).

### EVERYDAY BUFFET CASH REGISTER STAND

- 20 Gauge, 304 Stainless Steel Frame
- Locking Drawer
- 4" Swivel Casters With Two Brakes
- Open Storage Area
- Access Hole For Power Cord
- Matte Black Vinyl Clad



(Cash Register not included)

Model	Price	Length	Width	Height	Wt.	Cu. Ft.
BCRS-B	\$2291	22.7"	22.7"	34.4"	140 lbs.	19

### EVERYDAY BUFFET SILVERWARE STAND

- 20 Gauge, 304 Stainless Steel Frame
- Includes 12 Plastic Silverware Cups
- 4" Swivel Casters With Two Brakes
- Matte Black Vinyl Clad



(Trays & silverware shown not included)

Model	Price	Length	Width	Height	Wt.	Cu. Ft.
BSWS-B	\$2792	31.875"	22.4"	40"	160 lbs.	28

### Food Table Modifications & Accessories

For Our Full Line Of Hot Food Table Modifications, Accessories & Replacement Parts, See Page 131-134



SP-S - Spillage Pan



SU-6 - Push Handle

- TCB-OMIT** Remove Poly Cutting Board **-\$200 ea.**
- CB-OMIT** Remove Poly Cutting Board Only **-100 ea.**
- SP-A** Aluminum Spillage Pan **119 ea.**
- SP-S** Stainless Steel Spillage Pan **209 ea.**

- SU-6** Hot/Cold Food Table Handle **\$161 ea.**
- SU-19** Prepare Hot Tables To Be Locked Together (One Charge For Each Table To Be Interlocked) **513 ea.**
- SU-72** Upgrade 240 volt units to 3-Phase Wiring **448 ea.**



# ACCESSORIES

## Hot/Cold Food Table Shelving

### TRAY SHELVES

#### 10" Wide Stainless Steel Tray Shelves



STATIONARY		DROP-DOWN		Length	Approx Wt.	Cu. Ft.
Model	Price	Model	Price			
TTS-2	\$688	TTS-2D	\$807	31-13/16"	15 lbs.	3
TTS-3	811	TTS-3D	938	47-1/8"	17 lbs.	4
TTS-4	830	TTS-4D	999	62-3/8"	19 lbs.	5
TTS-5	997	TTS-5D	1115	77-3/4"	21 lbs.	6

#### 12" Wide Stainless Steel Tray Rails



STATIONARY		DROP-DOWN		Length	Approx Wt.	Cu. Ft.
Model	Price	Model	Price			
TTR-2	\$624	TTR-2D	\$730	31-13/16"	14 lbs.	3
TTR-3	767	TTR-3D	879	47-1/8"	16 lbs.	4
TTR-4	861	TTR-4D	943	62-3/8"	18 lbs.	5
TTR-5	1000	TTR-5D	1086	77-3/4"	21 lbs.	6

### 8" WIDE SHELF

With Removable  
3/8" Thick Poly Cutting Board



- All Stainless Steel Construction
- Cutting Board Attaches To Top Shelf Using Acorn Nuts

Model	Price	Length	Approx Wt.	Cu. Ft.
TCB-2	\$296	31-13/16"	16 lbs.	3
TCB-3	403	47-1/8"	19 lbs.	4
TCB-4	505	62-3/8"	23 lbs.	5
TCB-5	588	77-3/4"	26 lbs.	6

**TCB-OMIT** Remove Poly Cutting Board & Shelf **-\$200 ea.**  
**CB-OMIT** Remove Poly Cutting Board Only **-100 ea.**

### Replacement 3/8" Poly Cutting Boards



Model	Price	Length	Approx Wt.
SU-P-342	\$157	31-13/16"	9 lbs.
SU-P-343	190	47-1/8"	11 lbs.
SU-P-344	215	62-3/8"	13 lbs.
SU-P-345	229	77-3/4"	15 lbs.
SU-P-346	262	93-1/8"	18 lbs.

### 7" WIDE DISH SHELF

Connects To TCB Series Shelf

Includes 2 Side Panels & Lower Shelf



Poly Cutting Board & Top Shelf Not Included

Model	Price	Length	Approx Wt.	Cu. Ft.
TDS-2	\$546	31-13/16"	20 lbs.	3
TDS-3	651	47-1/8"	27 lbs.	4
TDS-4	861	62-3/8"	31 lbs.	5
TDS-5	992	77-3/4"	38 lbs.	6

### END SHELF FOR HOT/COLD TABLES

(Excludes HDRCP, HDSW & HDCPU Units)

- 10" Wide x 22 1/2" Length
- Stationary or Drop-Down
- All Stainless Steel Construction



Stationary Shelf Shown

STATIONARY		DROP-DOWN		Approx Wt.	Cu. Ft.
Model	Price	Model	Price		
TES-1	\$657	TES-1D	\$776	15 lbs.	3

### TABLE MOUNTED OVERSHELVES

- **TOS Series:** Upper Shelf Secures To Lower Shelf With Expander Hardward (Included)
- Shipped KD

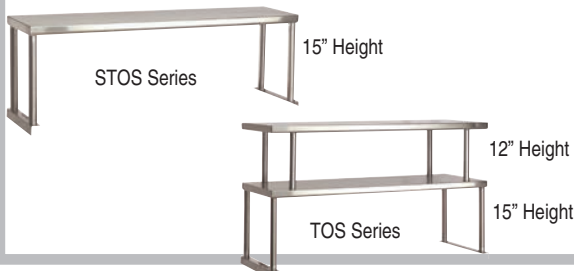

12" Wide			18" Wide				
Model	Price	Approx Wt.	Model	Price	Approx Wt.	Length	Cu. Ft.
<b>Single Tier</b>							
STOS-2	\$784	18 lbs.	STOS-2-18	\$997	20 lbs.	31-13/16"	3
STOS-3	890	21 lbs.	STOS-3-18	1074	23 lbs.	47-1/8"	4
STOS-4	1003	24 lbs.	STOS-4-18	1163	26 lbs.	62-3/8"	5
STOS-5	1086	27 lbs.	STOS-5-18	1269	30 lbs.	77-3/4"	6
<b>Double Tier</b>							
TOS-2	1423	32 lbs.	TOS-2-18	1691	35 lbs.	31-13/16"	3
TOS-3	1662	38 lbs.	TOS-3-18	1952	56 lbs.	47-1/8"	4
TOS-4	1898	44 lbs.	TOS-4-18	2231	66 lbs.	62-3/8"	5
TOS-5	2135	49 lbs.	TOS-5-18	2504	76 lbs.	77-3/4"	6

# ACCESSORIES

## Hot/Cold Food Table Food Shields



Meets Latest NSF Standards

### Sleek Shields™

Protected By: Patent No. US 9,010,883 B2



FEATURING ADVANCE TABCO'S REVOLUTIONARY CHAMBER LOCK™ ROTATION SYSTEM

Front Glass Locks Into Place At 15° Intervals

For Double Sided Sleek Shields™  
On Everyday Buffets Please Consult Factory

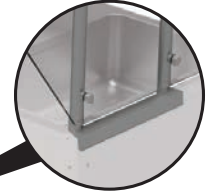

Includes TA-47 Mounting Brackets For In-Field Installation

NSG-15-4WELL Shown

### GLASS FOOD SHIELDS

Mounts To Top Of Hot/Cold Food Tables On Pg. 119-127 (Excluding Drop-In Wells)

#### Self-Serve Style

- 18 1/2" Standard Height (Top of Table To Top)
- 15" Wide Glass Top or Stainless Steel Shelf
- NSG Models: Shelves Have Square Edges On All Four Sides.
- GSG Models: Glass Top Features 3/8" Heat-Tempered Glass Top
- 1" Stainless Steel Tubing Posts
- Includes Two 18" Wide x 15-3/8" High Glass Side Panels
- 1/4" Thick Heat-Tempered Glass Front & Sides
- Shipped KD

15" Wide Stainless Steel Shelf			15" Wide w/ Glass Top			Fits # of Bowls	Approx. Wt.	Approx. Cubes
Model #	Price	O.A. Size L x W x H	Model #	Price	O.A. Size L x W x H			
NSG-15-2WELL	\$3134	33 9/16" x 19 3/4" x 18 1/2"	GSG-15-2WELL	\$3761	34 9/16" x 19 3/4" x 18"	Fits 2-Well Unit	109 lbs.	15
NSG-15-3WELL	3263	47 7/8" x 19 3/4" x 18 1/2"	GSG-15-3WELL	3902	49 7/8" x 19 3/4" x 18"	Fits 3-Well Unit	143 lbs.	22
NSG-15-4WELL*	3819	64 3/16" x 19 3/4" x 18 1/2"	GSG-15-4WELL*	4151	65 3/16" x 19 3/4" x 18"	Fits 4-Well Unit	186 lbs.	29
NSG-15-5WELL**	4171	78 1/2" x 19 3/4" x 18 1/2"	Not Available		Not Available	Fits 5-Well Unit	215 lbs.	38

GSG Series Food Shields are slightly longer than the table they rest on. They will extend about 7/8" on either end

\*3/8" Thick Heat-Tempered Glass Required For Front Glass

\*\*Requires a Single Center Post (Factory Print Included)

For Sleek Shield™ Modifications, Accessories and Heat Lamps, See Page 87

## CAFETERIA SHELVES W/ BUILT-IN ACRYLIC FOOD SHIELDS

Features Removable Stainless Steel Shelf

#### Single Sided Cafeteria Style

- 15" High
- 1" Clearance From Table Top



Model	Price	Length	Approx. Wt.	Cu. Ft.
TSS-2	\$976	31-13/16"	17 lbs.	2
TSS-3	1110	47-1/8"	20 lbs.	3
TSS-4	1211	62-7/16"	23 lbs.	4
TSS-5	1302	77-3/4"	33 lbs.	4

#### Double Sided Self-Serve Style

- 19-3/4" High
- 10" Clearance From Table Top



Model	Price	Length	Approx. Wt.	Cu. Ft.
TBS-2	\$1550	31-13/16"	28 lbs.	2
TBS-3	1599	47-1/8"	33 lbs.	3
TBS-4	1746	62-7/16"	38 lbs.	4
TBS-5	1999	77-3/4"	45 lbs.	4

#### Acrylic Side Panel for TSS Series Shelves

Add Side Panels To Meet Additional NSF Requirements (1 Panel Per End)

TSP-1 \$247 One End  
TSP-2 \$493 Two Ends

Field Installation Available

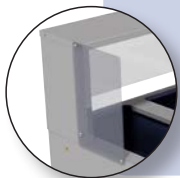

#### Acrylic Side Panel for TBS Series Shelves

Add Side Panels To Meet Additional NSF Requirements (2 Panels Per End)

TBP-1 \$296 One End  
TBP-2 \$593 Two Ends

Field Installation Available

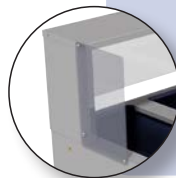

# ACCESSORIES

## Hot & Cold Table Accessories

### LED Display Lighting



#### Sleek Shields™ LED Display Lighting For Hot & Cold Tables

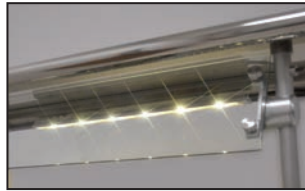

- Aluminum Rail with Shatter-Proof Optics
- Standard Natural Aluminum Finish. Available in White or Black
- Includes Class 2 Low Voltage Power Supply-120V-277V
- High Impact Resistant Mounting Clips
- On/Off Switch Included When Mounted on Advance Tabco Equipment

**Shelves Require 6" Clearance On Both Sides To Fit Above Led Lighting.**

**PRINT REQUIRED FOR PROPER LED LOCATION**

**FACTORY INSTALLED ONLY Includes Installation Charge**

L	S/S Shelf Mounted		Glass Top Mounted	
	Model #	Price	Model #	Price
1'	LED-S-12	\$355	LED-G-12	\$522
2'	LED-S-24	442	LED-G-24	613
3'	LED-S-36	509	LED-G-36	678
4'	LED-S-48	568	LED-G-48	739
5'	LED-S-60	632	LED-G-60	804
6'	LED-S-72	698	LED-G-72	865

### LED Display Lighting For Everyday Buffets & Hot/Cold Table Shelving



**LED-B Series** For Everyday Buffets



**LED-H Series** For Overshelves

- Aluminum Rail with Shatter-Proof Optics
- Available in White, Black & Natural Aluminum Finish
- Includes Class 2 Low Voltage Power Supply 120V-277V
- High Impact Resistant Mounting Clips

**NOTE: Require 6" clearance on both sides to fit above LED Lighting. PRINT REQUIRED FOR PROPER LED LOCATION FACTORY INSTALLED ONLY**

Fits # of Wells	For use with Everyday Buffets		For use with STOS, TOS, TBS or TSS Overshelves		LED Length
	Model #	Price	Model #	Price	
2	LED-B-2	\$1348	LED-H-2	\$1348	24"
3	LED-B-3	1580	LED-H-3	1580	36"
4	LED-B-4	1815	LED-H-4	1815	48"
5	LED-B-5	2078	LED-H-5	2077	60"
6	Not Available		LED-H-6	2350	72"

## HOT & COLD TABLE ACCESSORIES

#### Individual Well Covers For Hot Food Tables

- Stainless Steel
- Removable
- Fits All Advance Tabco Hot Well Units



**HFC-1 \$326 Per Well**



SP-A



TA-255P



SU-25S

#### Flip-Up Cover For Hot Food Tables

- Stainless Steel
- Removable
- Fits Advance Tabco Hot Well Units



Model #	Price	Fits # of		
		Comp.	Wt.	Cu.
RC-1	\$677	1	23	5
RC-2	767	2	60	10
RC-3	884	3	74	15
RC-4*	1231	4	120	20
RC-5**	1372	5	134	25

#### Hinge Style Cover For Cold Food Tables

- Stainless Steel
- Plastic Handles & Piano Style Hinge(s)
- Fits CPU, DICP & MACP & BMACP Units



Model #	Price	Fits # of		
		Comp.	Wt.	Cu.
HC-2	\$359	2	12	3
HC-3	537	3	16	4
HC-4	588	4	20	5
HC-5	683	5	24	6

#### Stainless Steel Legs & Undershelf Upgrade \$659

2 Well Table	3 Well Table	4 Well Table	5 Well Table	
SU-23A	SU-23B	SU-23C	SU-23D	
<b>SU-6</b> Hot/Cold Food Table Handle <b>\$161 ea.</b>				
<b>SU-25S</b> Add Casters to Food Units w/Undershelf (Includes 4-5" Swivel Casters, 2 w/ Brakes) <b>375 Set of 4</b>				
<b>SU-25</b> Add Casters to Food Units w/Undershelf (For Units Built Before October 2015. Includes 4-5" Swivel Casters, 2 w/ Brakes.) <b>375 Set of 4</b>				
<b>SU-19</b> Connect Cafeteria Items (One Charge For Each Table To Be Interlocked) <b>513 per table</b>				
<b>TA-25</b> Replacement Casters For Undershelf Units (For Units Built after October 2015. Includes 4-5" Swivel Casters, 2 w/ Brakes.) <b>375 Set of 4</b>				
<b>TA-255P</b> Add Casters to Enclosed Base Food Units (Includes 4-5" Bolted Swivel Casters, 2 w/ Brakes) <b>606 Set of 4</b>				
<b>SU-32G</b> Upgrade to a Stainless Steel Lining (For Gas Units. Excludes Wetbath Units) <b>115 per well</b>				
<b>SP-A</b> Aluminum Spillage Pan <b>119 ea.</b>				
<b>SP-S</b> Stainless Steel Spillage Pan <b>209 ea.</b>				
<b>TCB-OMIT</b> Remove Poly Cutting Board & Shelf <b>-200 ea.</b>				
<b>CB-OMIT</b> Remove Poly Cutting Board <b>-100 ea.</b>				

\* Supplied with Two RC-2 Covers

\*\* Supplied with One RC-2 & One RC-3 Cover



# REPLACEMENT PARTS

## Replacement Parts For Hot Food Tables

 All Items on This Page Ship via UPS

### FOR GAS HOT FOOD TABLES



#### Gas Valve

Hi/Med/Lo

SU-P-101 \$72



#### Valve Adapter

SU-P-104 \$43



#### Gas Pilot Valve

SU-P-108 \$53



#### Gas Regulator

SU-P-109 \$99



#### Jet Burners

SU-P-105 \$111

NAT 5/16 #61

SU-P-106 \$111

LP 5/16 #74



#### Gas Pilot

For Wet Bath Units

SU-P-107 \$173

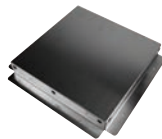

#### Gas Deflector

SU-P-411 \$30

Standard HFxG Units

SU-P-412 \$45

Stainless For SU-32G Wells



#### Pilot Assembly

HF-xG

SU-P-102 \$82



#### Gas Infinite Control Knob

SU-P-202 \$41



#### 1 1/2" Drain

Stainless Steel

For Wetbath Tables

SU-P-103 \$58

### FOR ELECTRIC HOT FOOD TABLES

#### ELECTRIC HEATING ELEMENTS

##### For Exposed Element (Dry) Models



SU-P-207 \$111

500W 120V

SU-P-204 \$111

1000W 240V

##### For Concealed Element Sealed Well (Wet) Models

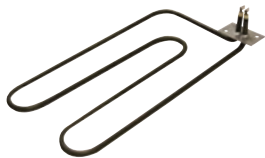

SU-P-209 \$128

640W 120V

SU-P-206 \$128

1100W 240V

SU-P-210 \$128

1100W 120V - For Drop-In Units Only



#### Thermostatic Control

#### Replacement Thermostatic Control

SU-P-220A \$203 Per Well

120v/240v, 24" lead For Free-Standing Sealed Well Hot Food Units

SU-P-220B \$203 Per Well

120v/240v, 24" lead For Drop-In Sealed Well Hot Food Units



#### Electric Infinite Control Knob

SU-P-201 \$41



#### Thermostatic Knob

(For Units with Thermostatic Control)

SU-P-219 \$44



#### Infinite Control

SU-P-205 \$98

120V

SU-P-215 \$98

240V



#### Indicator Lights

SU-P-216 \$70

120V

SU-P-217 \$70

240V



#### High Limit Switch Assembly

SU-P-208 \$150

250F

#### Replacement Sealed Well Sub-Assembly



SU-P-401 \$691

Without Element or High Limit Switch

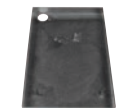

SU-P-402 \$40

Sealed Well or Element Pan Only

#### NEMA Plugs

6' Cord Set



SU-P-230 \$93

NEMA 5-20P



SU-P-231 \$260

NEMA L5-30P



SU-P-232 \$93

NEMA 6-20P



SU-P-233 \$260

NEMA L6-30P



SU-P-234 \$145

NEMA 5-15

# ALUMINUM RACKS

## Aluminum Pan Racks



**FRONT LOAD**

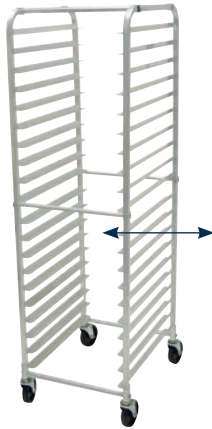

**SIDE LOAD**

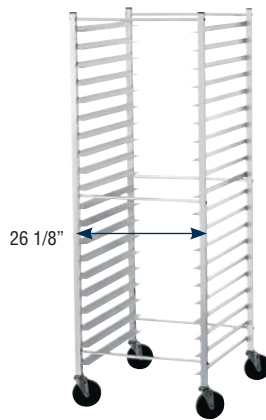

### K.D. PAN RACKS

- 6 Cylindrical Support Bars
- 1" Square Tubing
- 5" Poly Stem Bolted Casters
- 1 1/2" Ribbed Angles
- Shipped K.D.
- Easy To Assemble

Model #	Price	Description	Pan Capacity	Shelf Spacing	Overall Size	Approx. Wt.
<a href="#">PR10-3K</a>	<b>\$551</b>	Front Load	10 Full or 20 Half Size	3"	20 1/4" x 26" x 38 1/4"	14 lbs.
<a href="#">PR12-5K</a>	<b>580</b>	Front Load	12 Full or 24 Half Size	5"	20 1/4" x 26" x 69 1/4"	24 lbs.
<a href="#">PR18-3K</a>	<b>692</b>	Front Load	18 Full or 36 Half Size	3"	20 1/4" x 26" x 63 1/4"	31 lbs.
<a href="#">PR20-3K</a>	<b>654</b>	Front Load	20 Full or 40 Half Size	3"	20 1/4" x 26" x 69 1/4"	33 lbs.
<a href="#">PR30-2K</a>	<b>702</b>	Front Load	30 Full Size	2"	20 1/4" x 26" x 69 1/4"	39 lbs.
<a href="#">PR18-3KS</a>	<b>650</b>	Side Load	18 Full Size	3"	28 1/4" x 18" x 63 1/4"	31 lbs.
<a href="#">PR20-3KS</a>	<b>683</b>	Side Load	20 Full Size	3"	28 1/4" x 18" x 69 1/4"	27 lbs.

SEE PAGE 140  
FOR  
PROPER  
REPLACEMENT  
CASTERS



### ALL WELDED - CURVED TOP - STANDARD

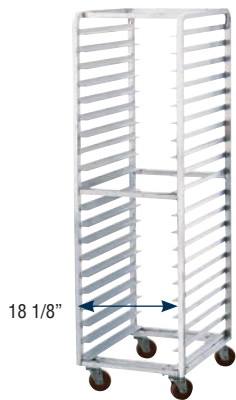

**SIDE LOAD**



**FRONT LOAD**

- Heavy Duty Welded Construction
- 1" Square Tubing
- Curved Top
- 5" Poly Stem Bolted Casters
- 6 Cross Supports
- 1 1/2" Heavy Duty Ribbed Angles

Model #	Price	Description	Pan Capacity	Shelf Spacing	Overall Size	Approx. Wt.
<a href="#">PR10-3W</a>	<b>\$639</b>	Front Load	10 Full or 20 Half Size	3"	20 1/4" x 26" x 38 1/2"	25 lbs.
<a href="#">PR10-6W</a>	<b>754</b>	Front Load	10 Full or 20 Half Size	6"	20 1/4" x 26" x 69 1/4"	27 lbs.
<a href="#">PR12-5W</a>	<b>769</b>	Front Load	12 Full or 24 Half Size	5"	20 1/4" x 26" x 69 1/4"	28 lbs.
<a href="#">PR15-4W</a>	<b>778</b>	Front Load	15 Full or 30 Half Size	4"	20 1/4" x 26" x 69 1/4"	31 lbs.
<a href="#">PR18-3W</a>	<b>790</b>	Front Load	18 Full or 36 Half Size	3"	20 1/4" x 26" x 63 1/4"	34 lbs.
<a href="#">PR20-3W</a>	<b>800</b>	Front Load	20 Full or 40 Half Size	3"	20 1/4" x 26" x 69 1/4"	35 lbs.
<a href="#">PR30-2W</a>	<b>938</b>	Front Load	30 Full or 60 Half Size	2"	20 1/4" x 26" x 69 1/4"	43 lbs.
<a href="#">PR10-6WS</a>	<b>856</b>	Side Load	10 Full Size	6"	28 1/4" x 18" x 69 1/4"	26 lbs.
<a href="#">PR12-5WS</a>	<b>867</b>	Side Load	12 Full Size	5"	28 1/4" x 18" x 69 1/4"	27 lbs.
<a href="#">PR15-4WS</a>	<b>959</b>	Side Load	15 Full Size	4"	28 1/4" x 18" x 69 1/4"	30 lbs.
<a href="#">PR18-3WS</a>	<b>982</b>	Side Load	18 Full Size	3"	28 1/4" x 18" x 63 1/4"	27 lbs.
<a href="#">PR20-3WS</a>	<b>991</b>	Side Load	20 Full Size	3"	28 1/4" x 18" x 69 1/4"	34 lbs.

# ALUMINUM RACKS

## Specialty Racks

### ENCLOSED PAN CABINETS

- 14 Ga. Aluminum, Heavy Duty Welded Construction
- Enclosed Extrusions
- 5" Poly Plate Casters, 2 With Brakes
- Flip Style Door Latch Handle
- Side Door Lock to Prevent Opened Door From Swinging
- 37 Pan Capacity
- Optional Bumpers Available
- Optional Pull Handle For Improved Mobility.
- Does Not Interfere With Other Side By Side Units.



Model #	Price	Description	Pan Capacity	Shelf Spacing	Overall Size	Approx. Wt.
EPC-40	\$2200	Front Load	37 Full or 74 Half Size	1 1/2"	20 1/2" x 27 1/2" x 66 1/4"	110 lbs.

### Optional Accessories

Model #	Description	Price
RA-21	Optional Pull Handle .....	\$317
RA-22	Full Perimeter Bumpers .....	222
RA-23	Corner Bumpers .....	177

### FULL & HALF SIZE CAN RACKS

Aluminum Top   Poly Top   Stainless Steel Top



Half Can Racks



Full Can Rack



Full Can Rack With Casters

### SPEC-LINE



- Heavy Duty Welded Construction
- Metal Bullet Feet on CR10-162 only
- 4" Plate Casters with two Brakes. Standard on all Can Racks EXCEPT CR10-162 (See CR10-162M).

Model #	Price	Description	Can Capacity		Overall Size	Approx. Wt.
			#10	#5		
CR10-162	\$1442	Full Can Rack	162	216	24 3/4" x 35 1/8" x 71"	65 lbs.
CR10-162M	1855	Full Can Rack (with Casters)	162	216	24 3/4" x 35 1/8" x 71"	76 lbs.
CR10-72	1453	Aluminum Top	72	96	24 3/4" x 35 1/8" x 40 1/8"	59 lbs.
CR10-54	1195	Aluminum Top	54	72	24 3/4" x 35 1/8" x 32 5/8"	54 lbs.
CRPL10-72	1603	Poly Top	72	96	24 3/4" x 35 1/8" x 40 1/8"	79 lbs.
CRPL10-54	1392	Poly Top	54	72	24 3/4" x 35 1/8" x 32 5/8"	74 lbs.
CRSS10-72	1529	Stainless Steel Top	72	96	24 3/4" x 35 1/8" x 40 1/8"	63 lbs.
CRSS10-54	1509	Stainless Steel Top	54	72	24 3/4" x 35 1/8" x 32 5/8"	55 lbs.

# ALUMINUM RACKS

## Aluminum Pan Racks



Front Load

### SPEC-LINE OVEN RACKS

Featuring High Temp Oven Plate Casters  
and All Welded Curved Top



- Heavy Duty Welded Construction
- 1" Square Tubing
- Curved Top
- 6 Cross Supports
- 4" Oven Plate Casters
- 1 1/2" Ribbed Angles

Model #	Price	Description	Pan Capacity	Shelf Spacing	Overall Size	Approx. Wt.
<b>CFL10</b>	<b>\$773</b>	Front Load	10 Full or 20 Half Size	6"	20 1/4" x 26" x 68 5/8"	37 lbs.
<b>CFL20</b>	<b>984</b>	Front Load	20 Full or 40 Half Size	3"	20 1/4" x 26" x 68 5/8"	45 lbs.
<b>CFL30</b>	<b>1027</b>	Front Load	30 Full or 60 Half Size	2"	20 1/4" x 26" x 68 5/8"	53 lbs.

### Optional Accessories



Model #	Description	Price
<b>RA-10</b>	Pan Stop .....	<b>\$120</b>
<b>RA-20</b>	Track Pin.....	<b>98</b>
<b>ORL-B</b>	Oven Lift .....	<b>151</b>

(For Front Load Pan Racks)

### REACH-IN RACKS

- All Welded Construction
- 1" Square Tubing
- Holds up to 16 Full or 32 Half Size Pans
- 3" Shelf Spacing
- 1" Front and Rear Cross Bracing
- Shipped KD

Model #	Price	Pan Capacity	Shelf Spacing	Approx. Wt.
<b>RR-16</b>	<b>\$576</b>	16 Full or 32 Half Size	3"	23 lbs.



### BUS BOX RACK

- Heavy Duty Welded Construction
- Curved Top
- 5" Stem Bolted Casters
- Overall Size: 20 3/8" x 19" x 40 7/8"



Model #	Price	Bus Box Capacity	Approx. Wt.
<b>BC3</b>	<b>\$521</b>	3	18 lbs.

Consult Factory For All Welded Reach-In Racks

### KEG RACKS

- 76" High, Aluminum Alloy Construction
- Shelves Are 1-3/4" Square Tubing
- 60 Lbs. Per Sq. Ft. Load Capacity Per Shelf
- Center Support Included On 93" Keg Shelves



Model #	Price	Size	# of Kegs (Per Unit)	Approx. Wt.
<b>KR-42</b>	<b>\$1183</b>	20" x 42"	4	50 lbs.
<b>KR-60</b>	<b>1260</b>	20" x 60"	6	68 lbs.
<b>KR-72</b>	<b>1331</b>	20" x 72"	8	80 lbs.
<b>KR-80</b>	<b>1385</b>	20" x 80"	8	88 lbs.
<b>KR-93</b>	<b>1713</b>	20" x 93"	10	100 lbs.



### Ke rack Rear Strap

Prevents Kegs From Sliding Off Rear Of Ke rack Shelf

Model #	Price	Approx. Wt.
<b>KR-1-42</b>	<b>\$139</b>	6 lbs.
<b>KR-1-60</b>	<b>153</b>	7 lbs.
<b>KR-1-72</b>	<b>155</b>	8 lbs.
<b>KR-1-80</b>	<b>171</b>	9 lbs.
<b>KR-1-93</b>	<b>188</b>	10 lbs.



# SPECIALTY RACKS

## Specialty Racks

### PIZZA PAN & DOUGH RACKS

#### Pizza Pan Rack



- All Welded Construction
- Solid Aluminum Top
- 12 Pan Capacity
- Holds Both Round And Square Pizza Pans
- 2" Shelf Spacing
- 5" Poly Stem Bolted Casters
- 4" Wide Slides

19 5/8"

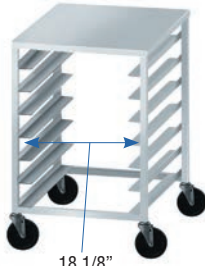

18 1/8"

#### PDB7

- All Welded Construction
- Solid Aluminum Top
- 7 Box Capacity
- 3 3/4" Shelf Spacing
- 5" Poly Stem Bolted Casters
- 2" Wide Slides

#### Pizza Dough Box Racks

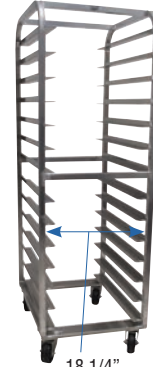

18 1/4"

#### PDB14

- All Welded Construction
- No Top
- 14 Box Capacity
- 3 3/4" Shelf Spacing
- 4" Plate Casters
- 2" Wide Slides

Model #	Price	Description	Overall Size	Approx. Wt.
<b>PZ12</b>	<b>\$1014</b>	Pizza Pan Rack	22" x 20" x 33 3/4"	52 lbs.
<b>PDB7</b>	<b>1079</b>	Pizza Dough Box Rack	26" x 20 1/4" x 33 3/4"	33 lbs.
<b>PDB14</b>	<b>1787</b>	Pizza Dough Box Rack (No Top)	26" x 20 1/4" x 61 1/2"	63 lbs.

### HALF SIZE RACKS



PR10-3WT Shown

- All Welded Construction
- 5" Poly Stem Bolted Casters
- 1-1/2" Ribbed Angles

#### PR7-4KT SERIES

- Removable Aluminum Top

PR7-4KT Shown



Model #	Price	Top	Description	Pan Capacity	Shelf Spacing	Overall Size	Approx. Wt.
<b>PR7-4KT</b>	<b>\$699</b>	Aluminum Top	Front Load	7 Full/14 Half Size	3 3/4"	20 5/8" x 26 7/8 x 36"	28 lbs.
<b>PR10-3WT</b>	<b>841</b>	Aluminum Top	Front Load	10 Full/20 Half Size	3"	20 1/4" x 26" x 38 1/2"	30 lbs.
<b>PR10-3PT</b>	<b>1050</b>	Poly Top	Front Load	10 Full/20 Half Size	3"	20 1/4" x 26" x 39"	45 lbs.
<b>PR10-3ST</b>	<b>1268</b>	Stainless Steel Top	Front Load	10 Full/20 Half Size	3"	20 1/4" x 26" x 39"	35 lbs.

\*Top shelf spacing on the PR7-4KT is 2-1/8"

### SPECIAL PURPOSE RACKS

#### Nesting Pan Rack

##### SPACESAVING DESIGN

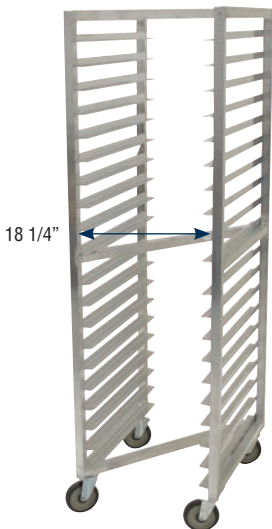

18 1/4"

- Nested Design To Facilitate Maximum Storage In Minimum Space
- Heavy Duty Welded Construction With "Diagonal" Cross Supports
- 1 1/4" Square Tubing
- 1" X 1-1/2" Ribbed Angles
- Heavy Duty Stem Casters
- 500 Lb. Capacity

Model #	Price	Pan Capacity	Shelf Spacing	Overall Size	Approx. Wt.
<b>NR-12</b>	<b>\$973</b>	12 Full or 24 Half Size	5"	21" x 26" x 69 1/4"	28 lbs.
<b>NR-20</b>	<b>\$1190</b>	20 Full or 40 Half Size	3"	21" x 26" x 69 1/4"	29 lbs.

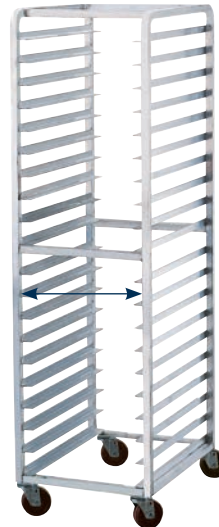

14 1/2"

#### Steam Table Pan Rack

- Heavy Duty Welded Construction
- 1" Square Tubing
- Curved Top
- 6 Cross Supports
- 5" Poly Stem Bolted Casters



Model #	Price	Pan Capacity	Shelf Spacing	Overall Size	Approx. Wt.
<b>STR20-3W</b>	<b>\$1079</b>	20 Full or 40 Half Size	3"	16 3/4" x 21 1/4" x 69 1/4"	34 lbs.

# ALUMINUM RACKS

## Aluminum Racks

### PLATTER RACK

- Heavy Duty Welded Construction
- 1" Square Tubing
- Curved Top
- 5" Poly Stem Bolted Casters
- 1 1/2" Ribbed Angles

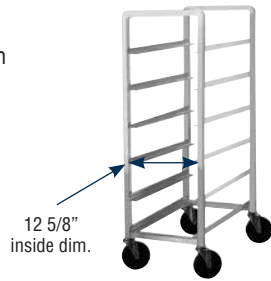

Model #	Price	Platter Capacity	Platter Size	Overall Size L x W x H	Approx. Wt.
PL6-12	\$825	6	12 1/2"	14 7/8" x 30" x 38 1/2"	21 lbs.

### LUG CARTS

- Heavy Duty Welded Construction
- 1" Square Tubing
- Curved Top
- 5" Stem Bolted Casters



Model #	Price	Lug Capacity	Overall Size L x W x H	Approx. Wt.
LR1	\$564	1	15 3/4" x 23 1/2" x 18 3/4"	15 lbs.
LR2	582	2	19" x 26" x 31 3/4"	18 lbs.
LR4	590	4	19" x 26" x 52 3/4"	21 lbs.
LR6	628	6	19" x 26" x 69 3/4"	23 lbs.

### UNIVERSAL RACKS

- Heavy Duty Welded Construction
- 1-1/4" Square Tubing
- 6 Cross Supports
- Heavy Duty 5" Stem Bolted Casters
- Stepped Angles
- Overall Size: 26" x 26" x 69 1/4"
- Front Tray Load

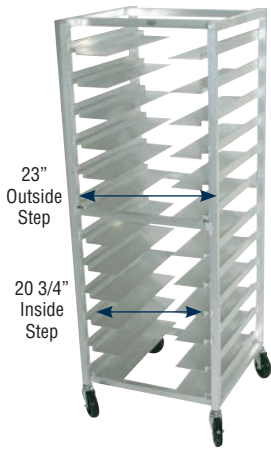

Model #	Price	Pan Capacity	Shelf Spacing	Approx. Wt.
UR10	\$1392	10 Full or 20 Half Size	6"	86 lbs.
UR12	1509	12 Full or 24 Half Size	5"	100 lbs.

### TRAY RACKS

Holds Baking Pans, Steam Table Pans & Service Trays

- Heavy Duty Welded Construction
- 1-1/4" Square Tubing
- Heavy Duty 5" Poly Stem Bolted Casters
- 4" Wide Angles
- Overall Size: 26" x 28" x 69 1/4"
- Front Tray Load

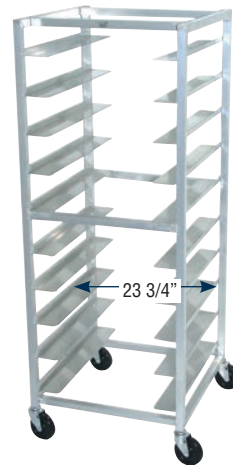

Model #	Price	Pan Capacity	Shelf Spacing	Approx. Wt.
OT10-6	\$1047	10 Full or 20 Half Size	6"	68 lbs.
OT20-3	1464	20 Full or 40 Half Size	3"	102 lbs.

### DONUT RACK

- Heavy Duty Welded Construction
- 1" Square Tubing
- Curved Top
- 6 Cross Supports
- 5" Poly Stem Bolted Casters
- Holds 23" x 23" and 24" x 24" Donut Screens
- Overall Size: 26 3/8" x 24" x 69 1/4"
- Front Tray Load

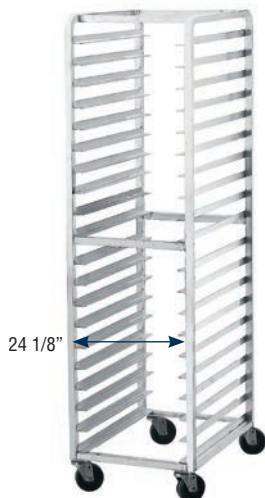

Model #	Price	Pan Capacity	Shelf Spacing	Approx. Wt.
DR20-3	\$811	20 Full or 40 Half Size	3"	39 lbs.

### WIRE PAN RACKS

- Heavy Duty Welded Frame Construction
- Curved Top
- 36 Full Size Pan Capacity
- 1 1/2" Shelf Spacing
- 6 Cross Supports
- 5" Stem Bolted Casters
- Nickel Chrome Plated Steel Wire Racks

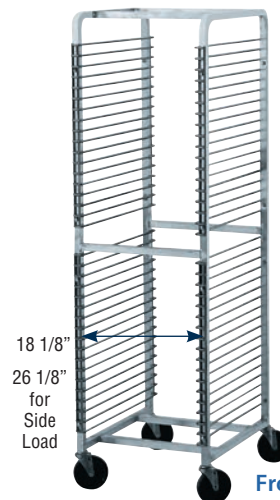

Front Load Shown



Model #	Price	Tray Load	Pan Capacity	Overall Size	Approx. Wt.
WR-36	\$991	Front	36 Full or 72 Half Size	20 1/4" x 25" x 70 1/4"	72 lbs.
WR-36S	1054	Side	36 Full Size	28 1/4" x 19 1/8" x 70 1/4"	64 lbs.

# BUN PANS

## Bun Pans & Accessories



Look For Our Advertisized  
Specials on Sheet  
Pan Pricing

## ALUMINUM BUN PANS

 = All Bun Pans Ship via UPS

Model #	Price	Size	Style	Gauge	Approx. Wt.
<b>18-A-26</b>	<b>\$36 ea.</b>	18" x 26"	Heavy Duty	16	48 lbs.
<b>18-8A-26</b>	<b>31 ea.</b>	18" x 26"	Standard	18	40 lbs.
<b>18-8P-26</b>	<b>42 ea.</b>	18" x 26"	Perforated	18	33 lbs.
<b>18-8A-13</b>	<b>27 ea.</b>	18" x 13"	Half Size	18	24 lbs.

**Packed One Dozen per Carton.**  
**No splitting of CARTONS permitted.**

## PAN RACK ACCESSORIES

All Pan Rack Accessories Ship via UPS



12" Tall  
Vertical  
Bumper

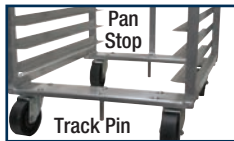

Pan  
Stop

Track Pin



Oven Lift for Front Load  
Pan Rack



Stem Bolted  
Caster



Hi-temp  
Oven  
Plate  
Caster



Plate  
Caster



Bun Pan  
Dolly  
Caster



PRC-1



PRC-2

### Bun Pan Rack Covers with 3 Zippers

**PRC-1** Enclosed Heavy Duty Plastic Cover.....**\$283 ea.**  
with Clear Front

**PRC-2** Economy See-Thru Plastic Cover..... **209 ea.**

**For Full Line of Aluminum Pan Racks,  
See Page 135-139**

Model #	Description	Weight Capacity	Approx. Weight	Price
<b>RA-10</b>	Pan Stop	-	3 lbs.	<b>\$120</b>
<b>RA-20</b>	Track Pin	-	3 lbs.	<b>101</b>
<b>RA-24</b>	12" Vertical Bumpers (Set of 4)	-		<b>138</b>
<b>RA-25</b>	5" Stem Bolted Caster	125 lbs.	4 lbs.	<b>50 ea.</b>
<b>RA-26</b>	5" Stem Bolted Caster w/ Brake	125 lbs.	4 lbs.	<b>60 ea.</b>
<b>RA-25SV</b>	5" Stem Bolted Caster for PR1803K, PR20-3K   & PR12-5K ONLY	125 lbs.	4 lbs.	<b>50 ea.</b>
<b>RA-26SV</b>	5" Stem Bolted Caster w/Brake for PR1803K, PR20-3K & PR12-5K ONLY	125 lbs.	4 lbs.	<b>60 ea.</b>
<b>RA-30</b>	4" Plate Caster w/ Built-in Zerk Grease Fitting	400 lbs.	4 lbs.	<b>171 ea.</b>
<b>RA-35</b>	4" Plate Caster w/ Brake	400 lbs.	4 lbs.	<b>180 ea.</b>
<b>RA-40</b>	4" Hi-temp Oven Plate Casters w/ Built-in Zerk Grease Fitting	300 lbs.	4 lbs.	<b>123 ea.</b>
<b>RA-45</b>	4" Hi-Temp Oven Plate Caster w/ Brake	300 lbs.	4 lbs.	<b>133 ea.</b>
<b>RA-50</b>	3" Bun Pan Dolly Caster	250 lbs.		<b>55 ea.</b>
<b>RA-60</b>	5" Heavy Duty Stem Caster for Universal & Oval Racks Only.	300 lbs.	4 lbs.	<b>80 ea.</b>
<b>RA-65</b>	5" Heavy Duty Stem Caster with Brake for Universal & Oval Racks Only.	300 lbs.	4 lbs.	<b>89 ea.</b>
<b>ORL-B</b>	18" Oven Lift For Front Load Pan Racks	-	1 lbs.	<b>151 ea.</b>

# RACKS & CARTS

Racks & Carts

## PAN TRUCK

- Heavy Duty Welded Construction
- 1" Square Tubing
- Curved Top
- Heavy Duty 3" Plate Casters
- Holds 60 Full Size Pans
- 600 lb. Weight Capacity



Model #	Price	Size	Approx. Wt.
PD-1	\$457	20" x 26 1/2" x 32"	20 lbs.

## UTILITY CARTS

- 2 Chrome Plated Numbered Posts
- 3 Adjustable Stainless Steel Shelves with Tapered Split Sleeves
- 4 Swivel Casters (2 w/Brakes) & Donut Bumpers
- 150 lb. Load Capacity
- Shipped Knocked Down



Model #	Price	Size	Shelf Size	Approx. Wt.
UC-3-1827	\$1292	31 3/4" x 18" x 38 1/4"	18" x 27"	25 lbs.
UC-3-2433	\$1687	37 3/4" x 24" x 38 1/4"	24" x 33"	40 lbs.

## GLASS RACK & PAN RACK DOLLIES

### Bun Pan Dolly



- Heavy Duty Welded Construction
- 3" Plate Casters
- Holds 60 Full Size Pans
- 600 lb. Weight Capacity



### Glass Rack Dolly

- Heavy Duty Welded Construction
- 3" Plate Casters
- 600 lb. Weight Capacity



Model #	Price	Description	Size	Approx. Wt.
 BPD-1	\$491	Bun Pan Dolly	26 3/4" x 18 3/4" x 5"	15 lbs.
 GRD-1	428	Glass Rack Dolly	20 1/2" x 20 1/2" x 5 1/4"	14 lbs.

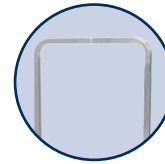

**Optional**  
Glass Rack Dolly Handle  
(Assembly Required)  
**RA-14 \$414**

## ALUMINUM DUNNAGE RACKS

### Stationary Dunnage Racks

8" & 12" Height Available



12" Height		8" Height		Size	# of Legs	Distribution Weight Capacity	Approx. Wt.
Model #	Price	Model #	Price				
DUN-2036	\$260	DUN-2036-8	\$260	20" x 36"	4	1500 lbs.	10 lbs.
DUN-2048	301	DUN-2048-8	301	20" x 48"	4	1800 lbs.	12 lbs.
DUN-2060	342	DUN-2060-8	342	20" x 60"	6	2000 lbs.	16 lbs.
DUN-2436	294	DUN-2436-8	294	24" x 36"	4	1500 lbs.	11 lbs.
DUN-2448	342	DUN-2448-8	342	24" x 48"	4	1800 lbs.	13 lbs.
DUN-2460	382	DUN-2460-8	382	24" x 60"	6	2000 lbs.	17 lbs.

### Mobile Dunnage Racks

- Four 6" Plate Casters (2 Swivel, 2 Stationary)
- Includes Pull Handle For Easier Mobility
- 2000 Lb. Rolling Capacity



**Now Includes Pull Handle**

### 36" Height with Handle

Model #	Price	Size	Distribution Weight Capacity	Approx. Wt.
DUN-2036C	\$694	20" x 36"	1500 lbs.	35 lbs.
DUN-2048C	766	20" x 48"	1800 lbs.	40 lbs.
DUN-2060C	891	20" x 60"	2000 lbs.	45 lbs.



# SHELVING

## Chrome & Green Epoxy Wire Shelving

All Items on This Page Ships via UPS

WIRE SHELVES **NSF**

Each Shelf Holds Up To 800 Lbs. Distributed Weight

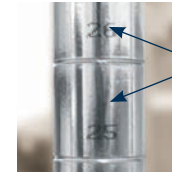
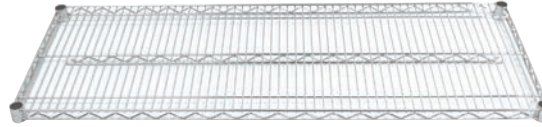

Posts are Numbered for easy assembly

	Shelf Size	CHROME	GREEN EPOXY	Price (Each)	Price (Set of 4)	Approx. Boxed Wt.	Approx. Boxed Cu. Ft.
<b>14" WIDE</b>	14" x 24"	<a href="#">EC-1424</a>	<a href="#">EG-1424</a>	<b>\$58</b>	<b>\$232</b>	35 lbs.	1.5
	14" x 30"	<a href="#">EC-1430</a>	<a href="#">EG-1430</a>	<b>61</b>	<b>244</b>	41 lbs.	2
	14" x 36"	<a href="#">EC-1436</a>	<a href="#">EG-1436</a>	<b>65</b>	<b>260</b>	47 lbs.	2.5
	14" x 42"	<a href="#">EC-1442</a>	<a href="#">EG-1442</a>	<b>71</b>	<b>284</b>	52 lbs.	3
	14" x 48"	<a href="#">EC-1448</a>	<a href="#">EG-1448</a>	<b>79</b>	<b>316</b>	58 lbs.	3.5
	14" x 60"	<a href="#">EC-1460</a>	<a href="#">EG-1460</a>	<b>87</b>	<b>348</b>	38 lbs.	2
	14" x 72"	<a href="#">EC-1472</a>	<a href="#">EG-1472</a>	<b>117</b>	<b>468</b>	45 lbs.	2.5
<b>18" WIDE</b>	18" x 24"	<a href="#">EC-1824</a>	<a href="#">EG-1824</a>	<b>64</b>	<b>256</b>	39 lbs.	2
	18" x 30"	<a href="#">EC-1830</a>	<a href="#">EG-1830</a>	<b>66</b>	<b>264</b>	45 lbs.	2.5
	18" x 36"	<a href="#">EC-1836</a>	<a href="#">EG-1836</a>	<b>71</b>	<b>284</b>	51 lbs.	3
	18" x 42"	<a href="#">EC-1842</a>	<a href="#">EG-1842</a>	<b>84</b>	<b>336</b>	56 lbs.	3.5
	18" x 48"	<a href="#">EC-1848</a>	<a href="#">EG-1848</a>	<b>87</b>	<b>348</b>	64 lbs.	4
	18" x 54"	<a href="#">EC-1854</a>	<a href="#">EG-1854</a>	<b>110</b>	<b>440</b>	35 lbs.	2
	18" x 60"	<a href="#">EC-1860</a>	<a href="#">EG-1860</a>	<b>114</b>	<b>456</b>	41 lbs.	2.5
18" x 72"	<a href="#">EC-1872</a>	<a href="#">EG-1872</a>	<b>133</b>	<b>532</b>	49 lbs.	3	
<b>21" WIDE</b>	21" x 24"	<a href="#">EC-2124</a>	<a href="#">EG-2124</a>	<b>68</b>	<b>272</b>	42 lbs.	2.5
	21" x 30"	<a href="#">EC-2130</a>	<a href="#">EG-2130</a>	<b>79</b>	<b>316</b>	49 lbs.	3
	21" x 36"	<a href="#">EC-2136</a>	<a href="#">EG-2136</a>	<b>85</b>	<b>340</b>	56 lbs.	3.5
	21" x 42"	<a href="#">EC-2142</a>	<a href="#">EG-2142</a>	<b>100</b>	<b>400</b>	62 lbs.	4
	21" x 48"	<a href="#">EC-2148</a>	<a href="#">EG-2148</a>	<b>106</b>	<b>424</b>	70 lbs.	4.5
	21" x 54"	<a href="#">EC-2154</a>	<a href="#">EG-2154</a>	<b>115</b>	<b>460</b>	39 lbs.	2.5
	21" x 60"	<a href="#">EC-2160</a>	<a href="#">EG-2160</a>	<b>129</b>	<b>516</b>	45 lbs.	3
21" x 72"	<a href="#">EC-2172</a>	<a href="#">EG-2172</a>	<b>150</b>	<b>600</b>	53 lbs.	3.5	
<b>24" WIDE</b>	24" x 24"	<a href="#">EC-2424</a>	<a href="#">EG-2424</a>	<b>78</b>	<b>312</b>	44 lbs.	3
	24" x 30"	<a href="#">EC-2430</a>	<a href="#">EG-2430</a>	<b>87</b>	<b>348</b>	51 lbs.	3.5
	24" x 36"	<a href="#">EC-2436</a>	<a href="#">EG-2436</a>	<b>97</b>	<b>388</b>	58 lbs.	4
	24" x 42"	<a href="#">EC-2442</a>	<a href="#">EG-2442</a>	<b>106</b>	<b>424</b>	64 lbs.	5
	24" x 48"	<a href="#">EC-2448</a>	<a href="#">EG-2448</a>	<b>114</b>	<b>456</b>	72 lbs.	5.5
	24" x 54"	<a href="#">EC-2454</a>	<a href="#">EG-2454</a>	<b>133</b>	<b>532</b>	41 lbs.	3
	24" x 60"	<a href="#">EC-2460</a>	<a href="#">EG-2460</a>	<b>140</b>	<b>560</b>	47 lbs.	3.5
24" x 72"	<a href="#">EC-2472</a>	<a href="#">EG-2472</a>	<b>160</b>	<b>640</b>	55 lbs.	4	

24" To 48" Length Shelves Are Packed 4 To A Box And 54", 60" And 72" Shelves Are Packed 2 To A Box.  
4 Pair Plastic Split Sleeves Are Included With Each Shelf.

## POSTS FOR WIRE SHELVING

Posts Are Numbered

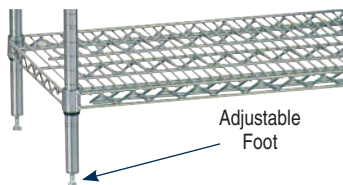

Post Height	Posts With Adjustable Foot				Posts For Casters <i>(Casters Priced Separately)</i>				Approx. Boxed Wt.	Approx. Boxed Cu. Ft.
	CHROME	GREEN EPOXY	Each	Set of 4	CHROME	GREEN EPOXY	Each	Set of 4		
14"	<a href="#">ECP-14</a>	<a href="#">EGP-14</a>	<b>\$27</b>	<b>\$108</b>	<a href="#">ECPC-14</a>	<a href="#">EGPC-14</a>	<b>\$28</b>	<b>\$112</b>	4 lbs.	.07
34"	<a href="#">ECP-34</a>	<a href="#">EGP-34</a>	<b>34</b>	<b>136</b>	<a href="#">ECPC-34</a>	<a href="#">EGPC-34</a>	<b>34</b>	<b>136</b>	8 lbs.	.18
54"	<a href="#">ECP-54</a>	<a href="#">EGP-54</a>	<b>38</b>	<b>152</b>	<a href="#">ECPC-54</a>	<a href="#">EGPC-54</a>	<b>39</b>	<b>156</b>	12 lbs.	.28
64"	<a href="#">ECP-64</a>	<a href="#">EGP-64</a>	<b>42</b>	<b>168</b>	<a href="#">ECPC-64</a>	<a href="#">EGPC-64</a>	<b>45</b>	<b>180</b>	15 lbs.	.33
74"	<a href="#">ECP-74</a>	<a href="#">EGP-74</a>	<b>49</b>	<b>196</b>	<a href="#">ECPC-74</a>	<a href="#">EGPC-74</a>	<b>49</b>	<b>196</b>	17 lbs.	.39
86"	<a href="#">ECP-86</a>	<a href="#">EGP-86</a>	<b>58</b>	<b>232</b>	<a href="#">ECPC-86</a>	<a href="#">EGPC-86</a>	<b>58</b>	<b>232</b>	20 lbs.	.45

## 5" CASTERS

Sets Feature 4 - 5" Swivel Casters (2 w/ Brakes & 4 Donut Bumpers)

Casters For Wire Shelving Only, See Page 60 For Casters For Tables.

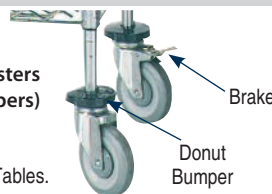

1000 lb. Max. Load Capacity For Shelving Casters

**EC-25** Rubber Casters.....**\$256 /set of 4**

**EC-26** Poly Casters..... **314 /set of 4**

# SHELVING

## Shelving Combos

### CHROME & GREEN EPOXY WIRE SHELVING COMBOS

Includes 4 Wire Shelves And 4 - 74" Posts



Chrome



Green Epoxy

Chrome		Green Epoxy		Shelf Size	Post Height	Approx. Wt.
Model #	Price	Model #	Price			
ECC-1436	\$456	EGG-1436	\$456	14" x 36"	74"	64 lbs.
ECC-1442	480	EGG-1442	480	14" x 42"	74"	69 lbs.
ECC-1448	512	EGG-1448	512	14" x 48"	74"	75 lbs.
ECC-1460	544	EGG-1460	544	14" x 60"	74"	93 lbs.
ECC-1472	664	EGG-1472	664	14" x 72"	74"	107 lbs.
ECC-1836	480	EGG-1836	480	18" x 36"	74"	68 lbs.
ECC-1842	532	EGG-1842	532	18" x 42"	74"	73 lbs.
ECC-1848	544	EGG-1848	544	18" x 48"	74"	81 lbs.
ECC-1854	636	EGG-1854	636	18" x 54"	74"	88 lbs.
ECC-1860	652	EGG-1860	652	18" x 60"	74"	99 lbs.
ECC-1872	728	EGG-1872	728	18" x 72"	74"	115 lbs.
ECC-2436	584	EGG-2436	584	24" x 36"	74"	75 lbs.
ECC-2442	620	EGG-2442	620	24" x 42"	74"	81 lbs.
ECC-2448	652	EGG-2448	652	24" x 48"	74"	89 lbs.
ECC-2454	728	EGG-2454	728	24" x 54"	74"	97 lbs.
ECC-2460	756	EGG-2460	756	24" x 60"	74"	111 lbs.
ECC-2472	836	EGG-2472	836	24" x 72"	74"	127 lbs.

### MOBILE CARTS

Includes 4 Chrome Wire Shelves And 4 - 64" Posts

- 4 Swivel Casters (2 with Brakes & 4 Donut Bumpers)
- Finished Height of 70"
- Weight Capacity Not To Exceed 1000 lbs. Total Weight



w/ Rubber Casters		w/ Poly Casters		Shelf Size	Approx. Wt.
Model #	Price	Model #	Price		
MC-1836R	\$720	MC-1836P	\$778	18" x 36"	43 lbs.
MC-1848R	784	MC-1848P	842	18" x 48"	55 lbs.
MC-1860R	892	MC-1860P	950	18" x 60"	86 lbs.
MC-2436R	824	MC-2436P	882	24" x 36"	62 lbs.
MC-2448R	892	MC-2448P	950	24" x 48"	76 lbs.
MC-2460R	996	MC-2460P	1054	24" x 60"	98 lbs.

FOR ADDITIONAL SHELVING, SEE PAGE 142

### WIRE UTILITY CARTS

- 3 Chrome Wire Shelves
- Tubular Numbered Handles
- 12 Plastic Split Sleeves
- 32" Finished Height
- 4 - Swivel Casters (2 w/ Brakes & Donut Bumpers)



Rubber Casters		Poly Casters		Size	Approx. Wt.	Approx. Cu. Ft.
Model #	Price	Model #	Price			
WUC-1836R	\$635	WUC-1836P	\$693	18" x 36"	53 lbs.	3
WUC-1842R	674	WUC-1842P	732	18" x 42"	55 lbs.	4
WUC-2436R	739	WUC-2436P	797	24" x 36"	58 lbs.	4
WUC-2442R	766	WUC-2442P	824	24" x 42"	61 lbs.	5

800 lb. Capacity      1000 lb. Capacity

### UTILITY CART HANDLES

34" Tubular Numbered Posts (Fits EC-25 And EC-26 Casters)

Model #	Price	Width
UCH-18	\$83 ea.	18"
UCH-24	96 ea.	24"



### SOLID STAINLESS STEEL SHELVES

Use With Chrome Posts Only (Posts Not Included)

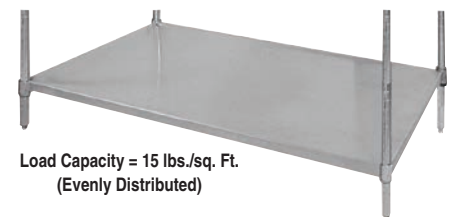

Load Capacity = 15 lbs./sq. Ft. (Evenly Distributed)

Model #	Price	Width
SH-1824	\$285 ea.	18" x 24"
SH-1836	357 ea.	18" x 36"
SH-1842	383 ea.	18" x 42"
SH-1848	427 ea.	18" x 48"
SH-1860	516 ea.	18" x 60"

# WIRE SHELVING

## Specialty Wire Shelving & Accessories

### WALL SHELF MOUNTING BRACKETS

Single Mount Includes 2 Brackets  
& 4 Collar Filler Caps

Double Mount Includes 1 Bracket

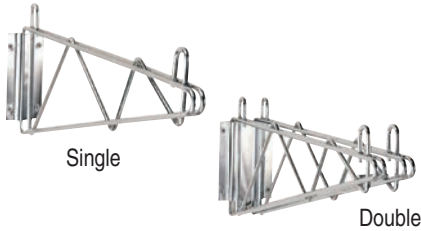

Chrome	Green Epoxy	Price	Size	Approx. Wt.
<b>SINGLE BRACKET</b>				
SB-14	GB-14	\$97	14"	2 lbs.
SB-18	GB-18	121	18"	3 lbs.
<b>DOUBLE BRACKET (For Adjoining Shelves)</b>				
DB-14	GDB-14	111	14"	3 lbs.
DB-18	GDB-18	145	18"	4 lbs.

### WALL MOUNTED SHELVING SYSTEM

Mounting Hardware Included • Shelves Sold Separately

#### End Mount Kit

- 4 Single Shelf Brackets
- 2 - 34" Posts
- Collar Filler Caps

**AB2-14 \$218**      **AB2-18 \$291**  
14" Wide              18" Wide

#### Mid-Mount Kit

- 2 Double Shelf Brackets
- 1 - 34" Posts
- For Adjoining Shelves

**ABM2-14 \$150**      **ABM2-18 \$179**  
14" Wide              18" Wide

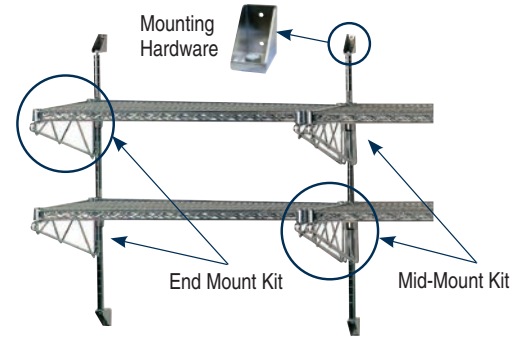

For Additional Tiers, Order Larger Posts On Page 140 With EC-50 Mounting Hardware For Each Post And Use The Following Brackets.

### WALL MOUNTED SHELVING SYSTEM EXPANSION KITS

- Includes Adjustable Bracket(s)

#### 2 Single End Mount Brackets

**AAB-14 \$60**  
14" Wide

**AAB-18 \$68**  
18" Wide

#### 1 Double Mid-Mount Bracket

**AABM-14 \$77**  
14" Wide

**AABM-18 \$88**  
18" Wide

#### Mounting Hardware

- Includes 2 End Mounts & 1 Mid-Mount Per Post

**EC-50 \$49**

## REPLACEMENT PARTS & ACCESSORIES



EC-10



EC-16



EC-20



EC-30



EC-15



EC-11



EC-5



EC-40

<b>EC-5</b>	<b>Post Clamp</b> .....	<b>\$17 ea.</b>
<b>EC-10</b>	<b>Replacement Leveling Foot</b> .....	<b>.11 ea.</b>
<b>EC-11</b>	<b>Foot Plate</b> .....	<b>16 ea.</b>
<b>EC-15</b>	<b>Chrome Collar Filler Caps</b> .....	<b>14 /pack</b>
	(For Add-Shelving and Wall Mounted Shelves - 4 per pack)	
<b>EC-16</b>	<b>Plastic Post Cap (4 pair per pack)</b> .....	<b>12 /pack</b>
<b>EC-20</b>	<b>Tapered Split Sleeves (4 per pack)</b> .....	<b>14 /pack</b>
<b>EC-30</b>	<b>S Hooks for add-shelving (2 pair per pack)</b> .....	<b>23 /pack</b>
<b>EC-40</b>	<b>Black Label Holder (3" x 1")</b> .....	<b>23 ea.</b>

### CASTERS FOR WIRE SHELVING

5" Swivel Stem Casters (2 w/ Brakes & 4 - Donut Bumpers)

Load Capacity Is 500 Lbs. Per Set.



#### Rubber

**EC-25 \$256**  
Set of 4



#### Poly

**EC-26 \$314**  
Set of 4

THESE CASTERS ARE FOR WIRE SHELVING UNITS ONLY.

See Page 62 For S/S Worktable Casters.

## ADVANCE TABCO WARRANTY

### General Terms for all Advance Tabco items (including those listed below):

- Warranty applies in the 48 contiguous United States only
  - ALL WARRANTY WORK MUST BE AUTHORIZED BY THE FACTORY BEFORE ANY WORK IS PERFORMED. Work performed without prior authorization shall be covered under this warranty only at the sole discretion of Advance Tabco
  - At no time will expenses to be paid under warranty exceed the original cost of the item
  - Routine maintenance and wear items are not covered by warranty.
  - Repair parts are sent by ground transportation. Any expedited freight charges will be at the expense of the end user
  - Warranty applies only under conditions of normal use and does not apply to defects which result from negligence, misuse, freight damage, improper installation or accidents.
  - Warranty does not include any coverage for loss of business, damages, freight or other miscellaneous expenses incurred due to the defect or in servicing the unit.
  - This warranty is made in lieu of all other warranties express or implied and no additional warranties express or implied, including one of merchantability or fitness for a particular purpose are given.
- If defects are the result of **freight or handling damage** your first recourse MUST be to notify the delivering freight carrier of the damage. If possible any damage should be noted on the delivery receipt at the time of delivery. Defects due to freight damage should be referred to the freight carrier for correction and compensation (this applies regardless of who was responsible for paying the freight charges or selecting the carrier).
  - **Hot Food and Refrigerated Tables and Drop-Ins** are warranted for 12 months from the date of shipment from the factory or 6 months from the date first placed into service (whichever comes first) and include the following terms:
    - Applies only to parts directly related to the electric, gas or refrigeration components of covered items (see below for all other parts)
    - Covers parts and labor during the warranty period (refrigeration components include labor coverage for 12 months from date of shipment or 3 months from date placed into service, with parts covered as described above). Labor performed after hours, as overtime, on weekends or on holidays is not covered by this warranty (end user may authorize and pay such expenses directly to service agency if desired)
    - Includes travel up to 100 miles round trip or 2 hours of travel time (additional travel will be at the end users expense)
  - **Refrigeration Compressors for Tables and Drop-ins are eligible for additional optional warranty coverage (if purchased):**
    - Must be purchased at the time the covered unit is ordered from the factory
    - Valid for 60 months from the date of shipment from the factory
    - Covers parts only (no labor, no freight). Applies only to the compressor unit
    - Excludes the cost of refrigerant
  - **Refrigerated underbar equipment (Glass Frosters, Bottle Coolers, Back Bar Refrigeration)** is warranted for 24 months from the date of shipment from the factory and includes the following terms:
    - Covers parts and labor during the warranty period. Labor performed after hours, as overtime, on weekends or on holidays is not covered by this warranty (end user may authorize and pay such expenses directly to service agency if desired)
    - Includes travel up to 100 miles round trip or 2 hours of travel time (additional travel will be at the end users expense)
    - Compressors only are warranted for a total of 60 months parts only (36 months parts after the initial 24 month parts and labor coverage)
  - **Ware Washing Machines** are warranted for 12 months from the date of shipment from the factory and include the following terms:
    - Covers parts and labor during the warranty period. Labor performed after hours, as overtime, on weekends or on holidays is not covered by this warranty
    - Includes travel up to 100 miles round trip or 2 hours of travel time (additional travel will be at the end users expense)
    - Any repairs or service conducted other than by an authorized service agent will void this warranty
  - **All Advance Tabco items not mentioned above (including parts not otherwise covered for hot food and refrigerated units)** are warranted free of defects in workmanship and materials for 90 days from the date of shipment from the factory. Warranty includes parts only (no labor). At Advance Tabco's discretion we may repair or replace the defective item.

## TERMS & CONDITIONS

All previous prices and discounts are hereby withdrawn

- All prices are F.O.B. factory.
- All prices, specifications and discounts subject to change without notice. Prices listed herein do not include Federal Excise, Municipal or other use Tax.
- Orders that are shipped to an active construction site or residential address are subject to additional charges by the carrier. These charges may be applied after shipment.
- Not responsible for any damage while in hands of carrier. Inspect immediately for hidden damage. (For any damage and loss while in transit, promptly file claim against carrier.)
- Merchandise shipped open account to those firms furnishing satisfactory credit references. Terms are 1% Discount - 10 days; Net - 30 days.
- Quotations, unless otherwise stated, are for 60 day acceptance.
- Returns: A 30% handling charge will be applied to all authorized returns. **Minimum charge \$50.00. Equipment older than 6 months is not eligible for returns.**
- A 50% handling charge will be applied to all unauthorized returns.
- Orders for special items are not subject to cancellation without our written consent.
- Our consent must be obtained before defective merchandise is returned. Incoming freight or express charges may be collected and exchanged items will be shipped prepaid.
- On return shipments that we sanction, where orders have been correctly filled out and not defective, the incoming freight or express charges must be prepaid. Credit will then be issued, less a reasonable handling charge and less whatever expense is necessary to put goods in salable condition.
- We are not responsible for any delays in delivery which are beyond our control such as fires, strikes, delays in transportation or any contingencies of similar character.
- All orders subject to acceptance at our office.
- Possession of price list does not constitute an offer to sell.
- Minimum charge on all orders is \$50.00 NET.

## GENERAL SHIPPING INFORMATION

1. We reserve the right to ship via carriers that in our opinion are the most efficient. We will follow customers routing if possible.
2. Unless specified, all orders shipped freight collect.
3. All "Drop Shipments" will be shipped "Prepaid & Charge".
4. Shipper is not responsible for any unauthorized accessorial charges. All charges will be billed back to customer.

## PREPAID FREIGHT CHARGES

- Minimum UPS charge = \$20.00.
- Estimated freight charges added to an invoice will include a nominal administrative charge per freight bill.

## ESTIMATED SHIPPING WEIGHTS ARE TO SERVE AS A GUIDE ONLY!

- Weights are averaged for all models within a given classification. Actual shipping weights may vary from those shown. Correct weight will be shown on your Bill of Lading.



Leading National Fabricator



# THANK YOU

For recognizing us Best-In-Class since 2001!

Work Tables - Sinks - Custom Stainless Steel Fabrication



Follow Us



[www.advancetabco.com](http://www.advancetabco.com) | [customer@advancetabco.com](mailto:customer@advancetabco.com) | Ph: 800-645-3166 | Fx: 631-242-6900  
Corporate Headquarters: 200 Heartland Blvd., Edgewood, NY 11717

National Manufacturing: Georgia<sup>2</sup> | Tennessee | Texas<sup>2</sup> | Mississippi<sup>2</sup> | New York | Kentucky | South Carolina | Nevada